

Fossicking

A guide to fossicking in NSW

2023

resourcesregulator.nsw.gov.au



Published by the Department of Regional NSW

Title: Fossicking

Subtitle: A guide to fossicking in NSW

First published: October 2010

Department reference number: RDOC23/72654

Acknowledgements

Project profile information has been provided by respective companies and has been represented as supplied.

© State of New South Wales through Regional NSW 2023. You may copy, distribute, display, download and otherwise freely deal with this publication for any purpose, provided that you attribute the Regional NSW as the owner. However, you must obtain permission if you wish to charge others for access to the publication (other than at cost); include the publication in advertising or a product for sale; modify the publication; or republish the publication on a website. You may freely link to the publication on a departmental website.

Disclaimer: The information contained in this publication is based on knowledge and understanding at the time of writing (March 2023) and may not be accurate, current or complete. The State of New South Wales (including Regional NSW), the author and the publisher take no responsibility, and will accept no liability, for the accuracy, currency, reliability or correctness of any information included in the document (including material provided by third parties). Readers should make their own inquiries and rely on their own advice when making decisions related to material contained in this publication.



Fossicking offers an opportunity to discover the beauty and diversity of NSW's mineral wealth, and contributes to the state's regional economies.

Contents

What is fossicking?	5
What are the potential environmental and social impacts of fossicking?	6
What are the restrictions on fossicking?	7
1. Restrictions on equipment	7
2. Surface disturbance restrictions	7
3. Restrictions on material taken	7
4. Mineral ownership	7
What fossicking equipment is permitted?	8
What fossicking equipment is NOT permitted?	9
Where can I fossick?	10
Fossicking Districts	10
Are there certain consents needed to fossick?	10
What other legislation should fossickers be aware of?	12
Further information	12
Changes to restrictions on power-operated equipment	13
What are the potential penalties associated with breaches of fossicking legislation?	13

What is fossicking?

Fossicking is a popular recreational activity involving the small scale search for, and collection of minerals, gemstones or mineral bearing material.

Fossicking offers an opportunity to discover the beauty and diversity of NSW's mineral wealth and contributes to the state's regional economies.

Fossicking is a lawful activity in NSW, however there are laws in place to protect NSW's natural environment and the rights of landowners and others with legitimate claims on the land, including native title.



What are the potential environmental and social impacts of fossicking?

Fossicking plays a significant part in the recreational history of NSW and continues to be enjoyed by many hobbyists today.

It is recognised that fossicking also provides a positive social and economic benefit for rural communities throughout NSW.

Fossicking takes place along river banks, in waterways and on land. Fossicking can be a benign activity when conducted in an environmentally sensitive manner. However, when conducted by concentrated groups of people or without awareness of the risks to the environment, ecological habitats, fishery habitat and stream ecology, fossicking can generate enduring environmental damage.

Disturbance of mud, clay or fine silt through digging, washing and sorting of material can result in direct and indirect impacts on aquatic habitats, vegetation and fauna such as native fish. Siltation, smothering of in-stream gravel beds, turbidity and disturbance of material from the bed or banks of waterways, can have a significant detrimental effect on the natural environment.

Fossicking activities on land can lead to the disturbance to soils, erosion and damage to ecological habitats, particularly if damage is not rehabilitated.

Fossicking activities can also lead to social impacts, causing disruption to landholders and their livelihood.



A pan being used to fossick resting on the bank of a body of water.

What are the restrictions on fossicking?

The *Mining Act 1992* and the *Mining Regulation 2016* set out a number of laws that people must adhere to when fossicking. These laws exist to ensure fossicking activity in NSW is conducted in an environmentally responsible manner to ensure the ongoing protection of our environment.

1. Restrictions on equipment

The use of explosives and any power-operated equipment for the purpose of surface disturbance, excavation or processing on any land, as a part of fossicking in NSW, is strictly prohibited.

On land or waters subject to native title, the only equipment permitted for use in fossicking is hand-held implements. Excavation or clearing is prohibited.

Power-operated equipment is defined in the *Mining Act 1992* as any equipment powered by mechanical or electrical means.

Although not defined in the legislation, set out below are the commonly understood meanings of other relevant terms:

- **Bushrock** means loose surface rocks or rock outcrops within areas of native vegetation.
- **Electrical** is any equipment powered by electricity.
- **Mechanical** is any equipment that has parts that move when it is working, often using power from an engine or from electricity.
- **Surface disturbance** is the disturbance, exposure, covering or erosion of the surface of land in any manner.
- **Excavation** is the extraction of material from the ground by digging.
- **Processing** is the act or process of treating or preparing something by a special method. In the case of fossicking, this is considered to include the washing of soil and other materials with water.

2. Surface disturbance restrictions

Soil, rock and other materials disturbed during fossicking must be removed and stockpiled separately. These materials must be replaced after completion to reconstruct the original soil profile.

In addition to this, no more than one cubic metre of any soil, rock or other material can be disturbed during any single 48-hour period. Bushrock must not be damaged or removed.

Any fossicking site must be left in a clean and tidy condition. All refuse, including bottles and cans must be removed from the site.

3. Restrictions on material taken

The following limits apply on the amount of material that can be taken per person during any single 48-hour period:

- 10 kilograms of mineral-bearing material (containing gold or gemstones)
- 5 kilograms of minerals (other than gold or gemstones)
- 5 nuggets of 10 grams or greater of gold
- 50 grams of gold (except where found as nuggets of 10 grams or greater)
- 100 grams of gemstones.

4. Mineral ownership

Publicly owned minerals, such as gold or gemstones, become the property of the person who found it when it is recovered during lawful fossicking. Where minerals are privately owned, ownership of those minerals needs to be agreed between the fossicker and the landholder or mineral owner. No royalties are payable on minerals found while fossicking, whether publicly or privately owned.

What fossicking equipment is permitted?

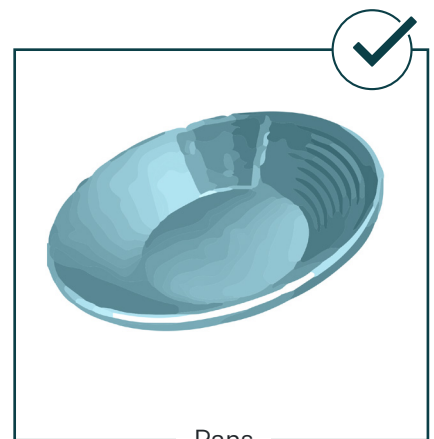

This is not an exhaustive list of all **permitted** equipment. For clarity, please see Restrictions on Equipment on page 7.

* Non-powered river sluices.

What fossicking equipment is NOT permitted?

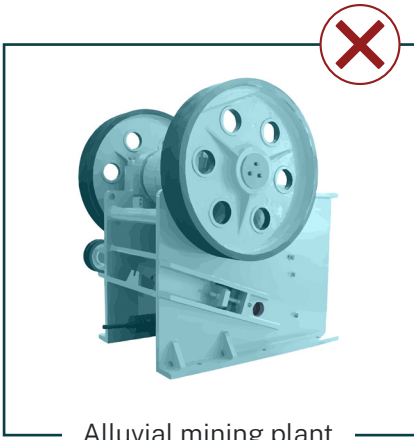
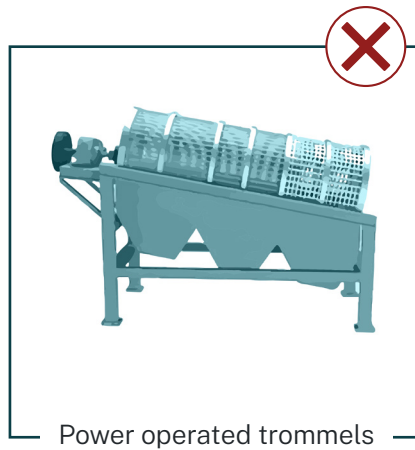
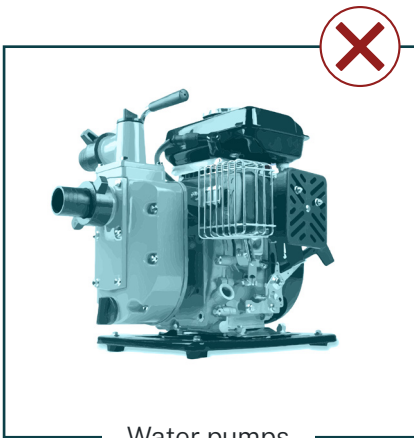
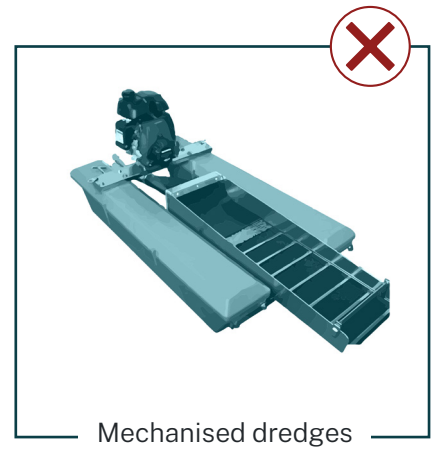
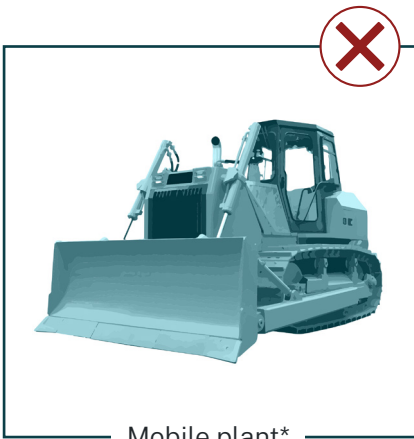

This is not an exhaustive list of all **prohibited** equipment. For clarity, please see Restrictions on Equipment on page 7.

* Mobile plant (backhoes, dozers, excavators).

** 'Highbanker' sluices, when used with powered water pumps.

Where can I fossick?

Fossicking Districts

To assist fossickers, the NSW Government has established a number of Fossicking Districts across NSW. Fossickers are not required to obtain consent from exploration licence holders located within the boundaries of a Fossicking District, however, all other consents as outlined below are still required.

The location of designated Fossicking Districts can be found by adding the Fossicking Districts layer on minview.geoscience.nsw.gov.au.

Are there certain consents needed to fossick?

Fossicking is permitted across much of NSW, however, certain consents are required before fossicking activities can take place.

1. Private land

The consent of the landholder must be obtained prior to fossicking on private land. Further information about identifying landholders is available from Land Registry Services at nswlrs.com.au.

Fossickers must comply with any conditions or requirements of the landholder. These could include, for example, which tracks to use, which paddocks to avoid, the use of gates or periods of access.

Landholders are indemnified under section 383C of the *Mining Act 1992* from any action, liability, claim or demand arising from the use of their land by fossickers in most circumstances. The indemnity does not apply where the landholder has been reckless or has intended to cause harm.



A sieve used for fossicking.

2. Resource titles, mineral claims and opal prospecting licences

Consent from the holder of an authority, mineral claim or opal prospecting licence must be obtained before any fossicking activity on the land subject to the authority, claim or licence can commence. This does not apply to fossicking on land that is subject to an exploration licence if the land is within a fossicking district.

Further information on the location of coal, mineral and petroleum titles, mineral claims or opal prospecting licences can be obtained from NSW Min View minview.geoscience.nsw.gov.au.

3. Crown land

Fossickers do not have the right to enter Crown Land. Prior to fossicking on Crown land, consent from the appropriate authority is required.

Where Crown Land is occupied by a tenure holder and/or Crown land manager, further consent may be required.

Further information about Crown Land can be found at crownland.nsw.gov.au or by calling 1300 886 235.

4. State forests

Fossicking is allowed with a permit in many NSW State forests. Permits are valid for 12 months and allow small scale fossicking for recreational, tourist or educational purposes in State forests across NSW.

Further information about fossicking in NSW State forests, including how to apply for a fossicking permit and maps showing where fossicking is or is not permitted, is available from the Forestry Corporation at forestrycorporation.com.au/visit/activities/fossicking.

Conducting fossicking within a forestry area without a permit can result in a penalty notice of \$100 and a maximum court imposed penalty of \$2200 (as per Section 67 *Forestry Act 2012*).

5. Native Title

Fossicking is not allowed on land or water subject to native title without the consent of the relevant registered native title body corporate.

Fossickers should contact NTSCORP Limited, the Native Title Service Provider for Aboriginal Traditional Owners in NSW and the ACT at ntscorp.com.au¹ to clarify whether the area they are considering to undertake fossicking is subject to native title.

A list of native title representative bodies in Australia can be found at niaa.gov.au².

6. National Parks

Fossicking is generally not permitted in National Parks, however, consent may be provided in certain circumstances.

Further information about fossicking in National Parks can be found at environment.nsw.gov.au³.

¹ <http://www.ntscorp.com.au/about-native-title/>

² <https://www.niaa.gov.au/indigenous-affairs/land-and-housing/native-title-representative-bodies-and-service-providers>

³ <https://www.environment.nsw.gov.au/topics/parks-reserves-and-protected-areas/park-policies/fossicking>

What other legislation should fossickers be aware of?

Although fossicking activities are primarily regulated under the *Mining Act 1992* and the *Mining Regulation 2016*, these activities are also impacted by the following legislation:

- *Forestry Act 2012* (NSW)
- *Fisheries Management Act 1994* (NSW)
The *Fisheries Management Act 1994* regulates a range of activities including those that harm the habitat of native fish (including threatened species of fish) and recreational fishing. Following the guidelines and avoiding the activities listed below will assist you in complying with this Act:
 - removing or disturbing any material that is important habitat for fish (including threatened species of fish) from the bed or banks of a waterway including woody debris (snags) greater than 3m in length, large cobbles, rocks or boulders (greater than 500mm in diameter) or aquatic vegetation; or
 - placing or reshaping any material across a waterway that may obstruct the free passage of fish.
- *National Parks and Wildlife Act 1974* (NSW) (in relation to Aboriginal cultural heritage)
- *Water Management Act 2000* (NSW)
- *Protection of the Environment Operations Act 1997* (NSW)
- *Native Title Act 1993* (Commonwealth)
- *Environmental Planning and Assessment Act 1979* (NSW)
- *Crown Land Management Act 2016* (NSW).

Fossickers should also familiarise themselves with the requirements under this legislation and associated Regulations.

Further information

- *Forestry Act 2012*, contact the Forestry Corporation NSW at forestrycorporation.com.au/visit/activities/fossicking
- *Fisheries Management Act 1994*, contact the NSW Department of Primary Industries at dpi.nsw.gov.au/fishing
- *National Parks and Wildlife Act 1974* and associated regulations, contact NSW National Parks and Wildlife Service at nationalparks.nsw.gov.au
- *Water Management Act 2000*, contact Natural Resource Access Regulator at water.dpie.nsw.gov.au
- *Protection of the Environment Operations Act 1997*, contact the NSW Environmental Protection Authority at epa.nsw.gov.au
- *Native Title Act 1993*, contact Federal Attorney-General's Department at ag.gov.au/legal-system/native-title
- *Environmental Planning and Assessment Act 1979*, contact the Department of Planning, Industry and Environment at planning.nsw.gov.au
- *Crown Land Management Act 2016* at crownland.nsw.gov.au

Changes to restrictions on power-operated equipment

Fossicking using explosives, power-operated equipment or any other equipment except a hand-held (not power-driven) implement has been prohibited in legislation since the implementation of the Mining (General) Regulation 1997.

In 2010, an amendment was made to the Mining Regulation to limit the prohibition on powered equipment that was used only for the purpose of surface disturbance, excavation or processing. This change allowed the use of metal detectors in fossicking, provided that there is no surface disturbance.

What are the potential penalties associated with breaches of fossicking legislation?

Under the *Mining Act 1992* and Mining Regulation 2016, failure to comply with any of the requirements outlined in this guide may result in fines of \$750 for an individual, \$1500 for a corporation, and a maximum court imposed penalty of \$5500.



A man uses a sieve to fossick in a body of water.

Resources Regulator
W: resourcesregulator.nsw.gov.au

