

Reduction of Greenhouse Gas Emissions in Steel Production

Final Report

Dr Jai Kant Pandit, Dr Max Watson & Dr Abdul Qader

March 2020, CO2CRC Report No: RPT20-6205



CO₂



CO2CRC Limited

11–15 Argyle Place South

Carlton VIC 3053

Australia

www.co2crc.com.au

Reference: **Pandit, J, Watson M and Qader, A, 2020. Reduction of Greenhouse Gas Emission in Steel Production Final Report. CO2CRC Ltd, Melbourne, Australia, CO2CRC Publication Number RPT20-6205.**

© CO2CRC 2020

Unless otherwise specified, CO2CRC Ltd retains copyright over this publication. You must not reproduce, distribute, publish, copy, transfer or commercially exploit any information contained in this publication that would be an infringement of any copyright, patent, trademark, design or other intellectual property right.

Requests and inquiries concerning copyright should be addressed to Chief Operating Officer, PO Box 1182, Carlton VIC 3053 Australia. **p:** +61 3 8595 9600 | **e:** info@co2crc.com.au

Acknowledgement

The current project is funded by Department of Planning, Industry and Environment through the Coal Innovation NSW Fund, which is administered by the Minister for Resources.

Any views expressed herein do not necessarily reflect the views of Coal Innovation NSW, the Department of Planning, Industry and Environment, the Minister for Resources, or the NSW Government.

The authors acknowledge the contribution of Dr Greg Knowles and Dr Gustavo A. Fimbres Weihs.

CO2CRC acknowledge the supports of BlueScope Steel Port Kembla Steelworks for proving the emissions data and report review, Lanzatech (USA) and Thyssenkrupp (Germany) for providing the required data on steel making, and carbon utilization processes.

Confidentiality

This report contains sensitive and confidential information. CO2CRC and contributing industries would need to consider confidentiality if a subset of the report were to be published.

Executive Summary

This report describes the main technology options available to the steel industry to reduce its CO₂ emissions. This CO2CRC Ltd project, funded by CINSW, has been supported by BlueScope Steel since its inception. LanzaTech (developer of a biochemical process to produce value added products from gases containing CO, CO₂ and H₂), and Thyssenkrupp AG (a major steel maker in Europe) have provided the technical input for utilization of steel mill gases for producing value added products.

The report gives a brief overview of the steel making processes. Steel making is an energy intensive and carbon intensive process with global average energy intensity of 19.76 GJ/tonne of steel and CO₂ emission intensity of 1.83 tonne CO₂/tonne of steel. The steel industry consumes 5.9 % of global energy and emits 6-9 % of global CO₂ emissions. Moreover, the world has seen an unprecedented increase in steel demand since the industrial revolution and that demand is expected to rise to 1.5 times the current demand in the next 30 years. These facts set the tone for decarbonizing the steel making processes so that the steel industry can maintain its eminent presence in a low carbon world.

Due to the inherent use of coal and coke in steel making process as a source of energy and as a reductant, total decarbonization of currently operating plants is not possible. However, a portfolio of technologies and approaches will be needed to address the decarbonisation challenge, while supporting steel industry competitiveness. Carbon capture and storage (CCS), carbon capture utilisation and storage (CCUS) and energy efficiency technologies can play a critical role in reducing steel sector CO₂ emissions and reduce the carbon footprint of existing steel plants. The global steel industry has been contributing towards various research, development and development of new technologies to reduce emissions from steel making processes. The report provides summary descriptions, highlights case studies and provides cost estimates for research, demonstration and commercial projects being planned or developed and the status of various global initiatives to reduce emissions from steel plants. The World Steel Association and the International Energy Agency have highlighted innovative technologies to reduce emissions from steel technologies. Both organizations have underlined the significance of hydrogen, CCS and CCU to reduce emissions from steel production and recommended innovation and development initiatives in these areas. European initiative ULCOS has flagship programs on top gas recycling and carbon capture from blast furnace gas and smelting reduction that can eliminate sintering and coking process in steel making. COURSE50, the Japanese initiative has focus on carbon capture and reduction of iron ore using hydrogen. The aim of the HYBRIT program of Sweden aims to develop a carbon free steel making technology based on hydrogen as the reducing agent and energy source. STEPWISE is another program of the European Union to reducing CO₂ emissions in steel making by developing advanced Pre-Combustion CO₂ removal from BFG by using the water gas shift reaction (WGS) and Sorption Enhanced Water-Gas Shift technology (SEWGS).

Any technology to reduce emissions from the steel making process will increase the energy demand for the steel plant. Therefore, adopting energy efficiency measures are very important for the steel industry to reduce the energy bills and to reduce emissions. Out of 60 energy efficiency measures listed by the Environmental Protection Agency (EPA) of US for integrated steel production in the US, this report describes 13 measures with greater technology diffusion. According to IEA, energy efficiency measures are going to be the biggest contributor to reducing emissions. However, best available energy efficiency technologies are already very close to thermodynamics energy thresholds.

¹ Given energy and emission intensities are global average of all processes of steel making.

The energy intensity of BlueScope Steel's Port Kembla Steelworks is among the best steel works, as they have already implemented some of the most effective efficiency measures described in this report.

Suitability of both chemical and biochemical technologies to utilize steel mill gases (SMGs) for producing value added chemicals are investigated in detail in collaboration with BlueScope and technology provider LanzaTech and Thyssenkrupp. Both the technologies; methanol via a chemical process developed by Thyssenkrupp and ethanol via a bio chemical fermentation process developed by LanzaTech have potential economic benefits but the emission reduction potential of these technologies is very moderate. Methanol production through a chemical process is not viable for BlueScope due to very limited availability of hydrogen bearing coke oven gas, to make the process viable, a cheap and clean hydrogen is needed. LanzaTech process-based ethanol production may be economically viable without use of COG or hydrogen, but the CO₂ reduction is minimal as efficiency of converting CO to ethanol depends on hydrogen content in the feed gas. These finding underpins the significance of hydrogen in utilizing SMGs for value added products and platform chemicals.

Carbon capture is a technically proven technology that could significantly reduce the CO₂ emissions from steel making. This technology could be implemented to capture CO₂ from blast furnace gas and is a subject of interest in ULCOS, COURSE50 and POSCO's programs. Implementing CO₂ capture from blast furnace gas requires modifications to the blast furnace and modifications in the distribution network of SMGs within an integrated steel plant. End of pipe CO₂ capture has potential for reducing CO₂ emissions from BlueScope's Port Kembla Steelworks.

CO₂ capture from flue gases at the coke ovens, power plant and blast furnace hot stoves were also considered in this report. These are the three major CO₂ sources (Coke ovens and power plant each have 3 separate emission points) in the plant that emit 60-65% of the total CO₂ emissions. Moreover, the CO₂ content in gases from all these sources is greater than 15%, making them suitable for CO₂ capture by a solvent absorption process. To minimize the modification in the existing power plant at BlueScope, a separate natural gas combined cycle plant has been considered to fulfil the energy and process steam requirement of the capture process. With 90% capture rate, CO₂ capture could reduce the total emissions by 45%. To complete the assessment of CCS options, a study is included for scoping economic evaluation of Port Kembla Steelworks CO₂ transport and storage options, wherein 4 different options including pipe line transport, ship transport and pipeline transport to a pipeline hub and onto a single-sink hub were evaluated with two different storage options at Darling basin's Pondie Range Trough and Nearshore Gippsland Basin's Barracouta Field.

The study proposes three pathways to reduce CO₂ emission at BlueScope's Port Kembla Steelworks based on the three major options; energy efficiency, CCUS and CCS.

Lay Summary

Global crude steel production reached 1,808.6 million tonnes in 2018 and global demand is expected to increase by 1.5 times by 2050 to meet the needs of our growing population. 70% of the steel is produced by the blast furnace process using coal as a raw material for process and source of energy. Use of coal is essential in the steel making process and therefore carbon dioxide (CO₂) emissions cannot be avoided. The steel industry contributes a quarter of global industrial emissions of CO₂ and 6-9% of total global emissions from fossil fuel. Emission reduction from the steel industry is essential to meet the global emission target to avoid global temperature rise.

Global initiatives to reduce emissions are focusing on carbon capture utilization and storage (CCS/CCUS), replacing coal in steel making either by biomass or by clean hydrogen. Only CCS /CCUS have been employed at a commercial scale. Use of hydrogen is at an initial stage of development and expected to be available for commercial application by 2040.

The steel making process produces gases that are rich in carbon monoxide, hydrogen and carbon dioxide. These gases, known as steel mill gases (SMG), have good energy value and are therefore currently being used in power generation within the steel plant to contribute to the power needs of steel making. However, with currently available technologies, these gases can be used to produce value added products like ethanol, methanol and urea, while also reducing emissions. Two such technologies are discussed in this report. The availability of clean hydrogen can significantly increase the production of value-added chemical. Implementation of CCS and CCUS can potentially reduce the emissions by 45%.

Improvement in energy efficiency, CCS/CCUS and use of hydrogen are proposed as pathways towards low emission steel making. Government incentive and support are required for deployment of carbon capture utilization and storage.

Contents

Acknowledgement	i
Confidentiality.....	i
Executive Summary.....	ii
Lay Summary.....	iv
Contents.....	v
List of Figures	vii
List of Tables	viii
List of Abbreviations	ix
1. Introduction	1
1.1 Background	1
1.2 Project Relevance.....	2
1.3 Aims and Objectives.....	2
2. Project Performance Measures	3
2.1 Milestones Achievement	3
3. Methodology.....	4
4. Steel Making Processes.....	4
4.1 Blast Furnace-Basic Oxygen Furnace	5
4.2 Electric Arc Furnace	5
4.3 Direct Reduction	6
5. Energy & Emission Intensity.....	6
5.1 Energy Intensity	6
5.2 Emission Intensity	8
6. Australian Steel Industry.....	11
6.1 Initiatives of Australian Steel Industry	11
6.1.1 Biomass in Steel Production.....	11
6.1.2 Dry Slag Granulation	13
6.1.3 Polymer Injection Technology.....	13
6.1.4 Outcome of Sustainability Initiatives by Australian Steel Industry.....	13
7. Initiatives for Reducing Emissions in Steel Production	14
7.1 ULCOS.....	16
7.2 HYBRIT.....	19
8. Major Sources of Emission.....	21
8.1 Coke making process	22
8.2 Sintering Process.....	22
8.3 Reduction of iron oxide in blast furnace.....	23

8.4	Basic oxygen furnace	23
8.5	Power plant.....	23
8.6	Emissions at BlueScope Steel.....	26
9.	Carbon Capture and Storage.....	27
9.1	Post Combustion Capture	27
9.2	Carbon Capture Readiness (CCR)	35
9.2.1	CCR in Iron and Steel Production	37
9.3	Carbon Capture & Storage at BlueScope Steel	38
9.3.1	Design Basis.....	39
9.3.2	Capture Plant Configuration	40
9.3.3	Cost of CO ₂ Capture	42
9.4	Transport and Storage (T&S) of Captured CO ₂	43
9.5	CO ₂ Avoided & Cost of CO ₂ Avoided	44
9.6	Carbon Capture and Utilization	44
9.6.1	Utilization Through Chemical Transformation.....	47
9.6.2	Utilization Through Bio-chemical Transformation.....	52
9.6.2.1	Ethanol from LanzaTech Process- LCA	54
9.7	BlueScope Steel – Utilization of Steel Mill Gases.....	57
9.7.1	Methanol Production from SMGs (Chemical Process)- BlueScope Case	58
9.7.2	Ethanol Production from SMGs (Bio-chemical Process)- BlueScope Case.....	61
9.8	Applicable Energy Efficiency Measures	64
9.8.1	Coke Dry Quenching.....	64
9.8.2	Coal Moisture Control.....	65
9.8.3	Pulverized Coal Injection.....	65
9.8.4	Natural Gas Injection	65
9.8.5	Top Pressure Recovery Turbines.....	65
9.8.6	Heat Recovery from Hot Blast Stoves	65
9.8.7	BOF Bottom Stirring	66
9.8.8	BOF Heat and Gas Recovery.....	66
9.8.9	Waste Heat Recovery in Sinter Plant	66
9.8.10	Improved Ladle Preheating.....	66
9.8.11	Thin Slab Casting & Strip Casting	66
9.8.12	Variable Speed Drives	67
9.8.13	Other	67
9.9	Process Modifications	67
10.	Pathways to Emission Reduction	68

10.1	Pathway- Improving Energy Efficiency.....	68
10.2	Pathway -Carbon Capture Storage Utilization	70
10.3	Pathway- Use of Hydrogen	71
11.	Conclusions	72
12.	Recommendations	73
	Appendix A.....	74
	References	91

List of Figures

Figure 1:- Steel making processes.....	5
Figure 2: Indexed global energy consumption/tonne of crude [3].....	7
Figure 3: Energy demand and intensity of iron and steel making [15].	7
Figure 4: Global industrial direct CO ₂ emissions [17].....	8
Figure 5:- Region wise Direct CO ₂ intensity of steel production.....	9
Figure 6:-CO ₂ emission intensity path for steel industry.....	10
Figure 7:- GHG emission trend based on average of voluntarily reported GHG emissions by steel companies (World Steel Organization)	10
Figure 8:- Innovative technologies for CO ₂ reduction in steel production.....	16
Figure 9: Summary of ULCOS Project	17
Figure 10: The ULCOS TGR-BF Concept in Lulea [36]	18
Figure 11: Simplified Diagram on HISARNA technology and the pilot plant at IJmuiden Steel work ...	19
Figure 12: Basic reaction in HYBRIT (Courtesy- HYBRIT)	20
Figure 13:- Time line for HYBRIT project	20
Figure 14:- HYBRIT concept of steel making.	21
Figure 15: Carbon flow in steel making process and sources of CO ₂ emission in an integrated steel plant	25
Figure 16: Development status of various CCS technologies.	29
Figure 17- Simplified process diagram for amine-based CO ₂ capture.....	30
Figure 18:- POSCO's CO ₂ capture plant processing 1000 Nm ³ /h of BFG.....	34
Figure 19: A basic configuration of CO ₂ capture plant.....	40
Figure 20:- Global cumulative CO ₂ emission reduction in steel production from 2017-2060.....	45
Figure 21: Utilization of captured CO ₂	46
Figure 22:- Utilization of steel mill gases for chemical production (courtesy- ThyssenKrupp Germany)	47
Figure 23:-Utilization of gases in a steel plant, Base case is the current practice (courtesy- Thyssenkrupp).....	50
Figure 24- Possible utilization routes of steel plant gases for methanol production [71]	51
Figure 25: CO ₂ emissions reduction potential for SMG utilisation by methanol production via TK-Process [Source: Thyssenkrupp].....	52
Figure 26: Generalized scheme for the LT process as applied industrial waste gas streams or biomass feedstock.....	53
Figure 27: Configuration of Methanol production process using steel mill gases for Scenario 1.	58
Figure 28: Configuration of Methanol production process using steel mill gases for Scenario 2	58
Figure 29:Schematic for steel plant gases utilization using LanzaTech technology for BlueScope Steel (Source: BlueScope Steel).....	61
Figure 30: Energy saving potential of various energy efficiency measures	69

Figure 31: CO₂ emission intensity for different production methods in steel making process [100]. ... 70

Figure A 1: Schematic representation of the cases modelled for this study 78

Figure A 2: Scope of ship transport 80

Figure A 3: Transport and storage costs per tonne of CO₂ supplied at low pressure (0.1 MPa). 83

Figure A 4: Transport and storage costs per tonne of CO₂ supplied at high pressure (15 MPa). 84

Figure A 5: Transport and storage costs at low pressure supply (0.1 MPa), expressed per tonne of CO₂ supplied, delivered and avoided..... 85

Figure A 6:-Sensitivity to parameter variations for CO₂ supplied at low pressure (0.1 MPa). 86

Figure A 7: Sensitivity scenario cost results per tonne of CO₂ supplied at low pressure (0.1 MPa). 87

Figure A 8: Sensitivity scenario cost results per tonne of CO₂ supplied at high pressure (15 MPa). 89

List of Tables

Table 1: Biomass based char for a typical Australian integrated steel making operation 12

Table 2: Biomass based char for a typical Australian EAF steel making operation 12

Table 3: Major CO₂ reduction initiatives worldwide..... 15

Table 4: Composition of fuel gases used to generate power at the Port Kembla Steelworks (courtesy-BlueScope)..... 23

Table 5:-Consumption of carbon bearing materials in an integrated steel plant (based on the input from BlueScope Steel)..... 26

Table 6: CO₂ emission at various emission point for BF/BOF route of steel production (data based on various sources) 30

Table 7- Composition of flue gas at various stacks of BlueScope Steel..... 31

Table 8:- Steel Plant Off gases consumers and CO₂ emissions at various points as shown in Figure 15 (Based on 2019 emission data provided by BlueScope Steel) 32

Table 9:- Comparison of amine and ammonia-based solvents for CO₂ capture 34

Table 10: Performance and energy requirements for a range of capture technologies available for the steel industry [49] 35

Table 11:- Proposed International Definition of CCS Ready by GCCSI..... 36

Table 12: Flow and composition of three major sources of CO₂ emission at Port Kembla Steelworks. 39

Table 13: Capture plant specifications..... 41

Table 14: Performance of the gas turbine and HRSG 42

Table 15: Capital Cost for capture plant 43

Table 16:- Break up of annual utilities cost..... 43

Table 17:Availability of steel plant gases with composition at Thyssenkrupp Steel Duisburg plant (data -courtesy Thyssenkrupp), numbers in bracket are based on data provided by BlueScope Steel for Port Kembla Steelworks..... 50

Table 18:- Pilot, Demonstration and Commercial Plants that demonstrated LanzaTech technology 54

Table 19:Summary of key input items for the LCA studies for LT-Process as adapted to steel production facilities in Handler et al. 55

Table 20: Summary of findings of various LCA studies of LanzaTech Process. 56

Table 21:- Generation and consumption of SMGs at BlueScope Steel (courtesy BlueScope) 57

Table 22:Boundary, Stream and GHG Emission data for the assessment of TK-MeOH from Port Kembla Steelworks' SMG [Source: Thyssenkrupp (BlueScope Steel, 2019) and CO2CRC] 60

Table 23: Parameters determined by LanzaTech and BSL to be suitable to assess the technical and financial viability of the LT-Process integrated with Port Kembla Steelworks..... 62

Table 24: Gas streams and estimated emission for the assessment of LT-EtOH from Port Kembla Steelworks SMGs [Source: BlueScope Steel and CO2CRC assessment]..... 62

Table A. 1:- Underpinning technical inputs that form the basis of this economic study. 76

Table A. 2:-Underpinning economic assumptions that form the basis of this economic study. 77

Table A. 3:-Flow rate and transport distance for the single source cases modelled..... 78

Table A. 4:-Flow rate and transport distance for the hub cases modelled 79

Table A. 5:- Injection location parameters [102]. 79

Table A. 6:-Sensitivity analysis scenarios explored 82

List of Abbreviations

Abbreviation	Description
APGT	Australian Power Generation Technology
BFG	Blast Furnace Gas
BSL	BlueScope Steel
CAPEX	Capital Cost
CCS	Carbon Capture & Storage
CCU	Carbon Capture & Utilization
COG	Coke Oven Gas
EtOH	Ethanol
GHG	Green House Gases
ICCSEM	Integrated Carbon Capture and Storage Economics Model
LCA	Life Cycle Analysis
LDG	Linz Donawitz Gas (Basic oxygen furnace gas)
LT	LanzaTech
MeOH	Methanol
MTPA	Million Ton per Annum
NEM	National Electricity Market
OPEX	Operating Cost
SMG	Steel Mill Gases (BFG, COG, LDG)
T & S	Transport & Storage
TK	Thyssenkrupp

1. Introduction

Iron and steel have been playing a significant role in development of civilizations since 3000 BC. Steel's strength, durability, flexibility and ability to be endlessly recycled make it a critical component of sustainable infrastructure. Due to its universal and desirable properties, steel production is nearly 20 times higher than the total production of all non-ferrous metals put together [1]. The use of steel is ever growing. Global crude steel production reached 1,808.6 million tonnes (Mt) for the year 2018 [2] and is expected to increase by 1.5 times by 2050 in order to meet the needs of our growing population [3]. However, the essential use of coal and coke in the steel making process makes the steel industry a major emitter of greenhouse gases in form of CO₂. In 2018, the total CO₂ emission from the global steel industry was 7% -9% of total global CO₂ from fossil fuels [4]. Major components of a low carbon economy such as wind energy, low carbon transport, sustainable infrastructure and recycling facilities also depend on steel-based products. Therefore, it is essential to transform the steel industry by reducing its greenhouse gas emissions for it to be suitable for the realisation of a low carbon future. The iron and steel industry provide both challenges and opportunities in reducing the greenhouse gas emissions and making the industry sustainable.

1.1 Background

CO2CRC Limited (CO2CRC) supports industries to reduce greenhouse gas emissions through carbon capture and storage/ utilization (CCS/CCUS). CO2CRC is an active participant and leader of capture and storage projects globally and provides expert advice to emerging and existing CCS projects. BlueScope Steel (BSL) is a flat steel producer for the Australian, New Zealand and US markets, and is a leading international supplier of steel products and solutions. Their steelworks at Port Kembla - in New South Wales' Illawarra region - is the largest steel production facility in Australia with an annual production capacity of approximately 3.0 million tonnes of crude steel [5].

The CO2CRC team has visited the Port Kembla Steelworks, reviewed and understood plant CO₂ emissions and steel mill gases (SMG) data and their usage. CO2CRC has also built on previous discussions with the biochemical technology provider on the applicability and merits of their technology in the context of the Port Kembla Steelworks.

Coal Innovation NSW (CINSW) is a ministerial advisory body comprised of representatives of industry, research institutes and the NSW Government established under the Coal Innovation Administration Act 2008. The primary function of CINSW is to give advice and make recommendations to the Minister concerning the funding of projects, including this project, and other activities, from the CINSW Fund. CO2CRC, with strong support from BlueScope Steel, made a proposal to CINSW to fund a project to explore reduction of CO₂ emissions in steel production and to utilize steel mill gases (SMG) containing carbon monoxide (CO) and carbon dioxide (CO₂). In January 2019, CINSW engaged with CO2CRC to conduct research study into reducing greenhouse gas emissions in steel production with BlueScope Steel providing the relevant information for the study from their steel works in Port Kembla.

The project is to assess innovative technologies to reduce emissions from an integrated steel mill. This includes energy efficiency improvement measures, carbon capture utilization and storage, and use of hydrogen in steel making. The project also explores the utilization of CO and CO₂ in steel mill gases to produce value added products like ethanol, methanol and fertilizers through biochemical and chemical processes. The assessment of carbon capture from emissions points within an integrated steel mill, and storage of captured CO₂ is included in the project.

1.2 Project Relevance

According to the Department of Environment and Energy (Australian Government), Australia's direct greenhouse gas emissions in 2017 was 530.8 Mt CO₂-e including 53.7 Mt CO₂-e from manufacturing sector [6]. With an annual production capacity of 3 million tonnes of crude steel, BlueScope Steel's reported direct emission for 2017-18 was 6.27 MT CO₂-e. This is approximately 11.8% of the total direct emissions from manufacturing sector in Australia. According to World Steel Association, in 2017, Australia produced 5.3 million tonnes of steel [7]. This means a significant portion of emissions from the manufacturing sector is from steel industries. So, to reduce emissions from the manufacturing sector, iron and steel industries have a significant role to play. In an integrated steel mill, iron and steel making processes produce a large quantity of off gases. These off gases are referred to as steel mill gases (SMG) in this report. The ironmaking process produces blast furnace gas (BFG), the steel making process produces basic oxygen furnace gas (LDG) and coke making produces coke oven gas (COG). SMG contain CO, CO₂ and H₂ in various quantities and are a good source of energy.

According to the World Steel Association, SMG can be fully reused either as direct fuel substitute or for internal captive power generation [3]. However, the full utilization of gases is a challenge due to the operation plan and sequence of various furnaces, ovens and stoves and batch wise production of gases. In a typical steel plant around 2.5% of COG, 5.5% of BFG and 26% of LDG is flared [8]. Flaring of these gases means waste of energy and increase in emissions without any productive activities. During normal operation at BlueScope Steel's integrated plant at Port Kembla, COG and BFG are almost totally consumed within the site. BFG and COG are used as a fuel in various furnaces and boilers. The surplus energy is used to generate electricity through a steam cycle. Any SMG not able to be fired in the boilers or not used in any other duty in metallurgical processes are flared. Currently, BlueScope is flaring all of the LDG generated by steel making process [9]. This means a high quality heat energy is being wasted with flaring of LDG. The options for reducing CO₂ emissions through utilisation of SMG to produce value added products is also explored in the current project. The project addresses the opportunities and challenges in reducing CO₂ emissions from steel production process.

1.3 Aims and Objectives

This study was established by CINSW to explore options available to steel producers towards helping better realise their steel production operations as part of a low carbon future[10]. It is targeted to explore options available to help reduce the CO₂ emissions from steel production operations and to utilize CO and CO₂ from SMG (refer signed deed[10]). The project has following objectives:

- Evaluation of emerging global technologies for emission reduction from an integrated steel making facility.
- Understand the potential to reduce emissions from steel plant by proposing options for SMG utilization.
- Ascertain suitability of bio-chemical process to convert steel plant gases to value added ethanol as an alternative fuel for transport industry.
- Evaluate CO₂ capture options from all major emission sources at the BlueScope steel plant in Port Kembla.
- Evaluate viability of various transport and storage options for captured CO₂ including a review of potential CO₂ storage locations and a high-level review of the economics and viability of CO₂ transport options to these sites. (trucking, piping, shipping)

2. Project Performance Measures

2.1 Milestones Achievement

Milestone & Task	Performance Measures	Status	Relevance to Project and Achievements
<p>Milestone #1 – Australian & Global Steel Industry</p> <ul style="list-style-type: none"> Data analysis of energy and emission intensity of steel industry Review Australian measurements/initiatives in reducing greenhouse gases in steel industry Review global (Europe, US, China & Japan) measurements/initiatives in reducing greenhouse gases in steel industry Report 	<p>At least two global initiatives need to be included. The report outcomes will be reviewed by experts within CO2CRC.</p> <p>A contract with the process technology licensor.</p>	100% complete	<p>Need to reduce emission from steel industry.</p> <p>Status of development of technologies for emission reduction and suitable available technology.</p>
<p>Milestone #2 – Emission reduction</p> <ul style="list-style-type: none"> Major Sources of emission CCS readiness Applicable Emission reduction technologies Applicable energy efficiency measures Process modifications Report 	<p>The report outcomes will be reviewed by both CO2CRC and BlueScope. BlueScope would verify if all possible emission sources are included.</p>	100% complete	<p>Characterising the emission from steel making.</p> <p>Exploring suitable technology for emission reduction.</p> <p>Impact of emission reduction technologies on steel plant.</p> <p>Energy efficiency and emission reduction.</p>
<p>Milestone #3 – Steel Mill gases utilisation & cost analysis</p> <ul style="list-style-type: none"> Waste gas utilisation power generation vs biochemical process Cost analysis of CO₂ reduction Cost analysis of waste gas utilisation Report 	<p>The report outcomes will be reviewed by both CO2CRC and BlueScope with comments from Lanzatech.</p>	100% complete	<p>Options of using steel plant waste gas for producing value added chemicals.</p> <p>Establishing economic viability of emission reduction technologies.</p>
<p>Milestone #4 – Roadmap for emission reduction</p> <ul style="list-style-type: none"> Recommendations Pathways for emission reduction Draft/Final report 	<p>The draft/final report outcomes will be reviewed by both CO2CRC and BlueScope.</p>	100% complete	<p>What needs to be done and how to implement the emission reduction measures in steel making.</p>

3. Methodology

To achieve the project objectives and to complete project milestones, the following approach was devised:

- During the initial phase of the study, major emerging technologies for reduction of energy intensity and emission intensity of steel making process will be described. Berkeley National Laboratory and US EPA has listed more than 56 such global technologies [11].
- Describe the current global initiatives (by EU, Japan, China, Korea, USA) to reduce greenhouse gas emission from steel production.
- Explore in detail the initiatives/technologies that are suitable for Australian conditions, based on feed gas composition, process technologies and cost of implementation. BlueScope will advise on suitability of technologies.
- Explore the technologies for utilization of steel plant gases. Contact technology providers and investigate the suitability of technologies for BlueScope.
- Analyse the operation and emission data from BlueScope's Port Kembla Steelworks.
- In consultation with BlueScope, identify the challenges for implementing the suitable technologies and address them.
- Perform a preliminary techno economic analysis of suitable emission reduction technologies in consultation with BlueScope.
- Prepare an indicative general pathway for implementation of emission reduction measures in steel production.

4. Steel Making Processes

A brief description of iron and steel making process is provided in this section. The details of the iron and steel making technologies and processes can be found in the standard text books [12, 13]. As shown in Figure 1, there are three leading processes that produce steel.;

- I. Blast Furnace - Basic Oxygen Furnace (BF-BOF),
- II. Direct Reduction – Electric Arc Furnace (DR-EAF)
- III. Electric Arc Furnace (EAF)

Blast furnace and smelting reduction furnace produce hot liquid iron, whereas Direct Reduction produces sponge iron. BOF and EAF produce liquid steel. The electric arc furnace (EAF) is the steel producing technology that can also produce steel using only steel scrap as the raw material. Less than 1% of the global steel is produced through the Smelting Reduction process.

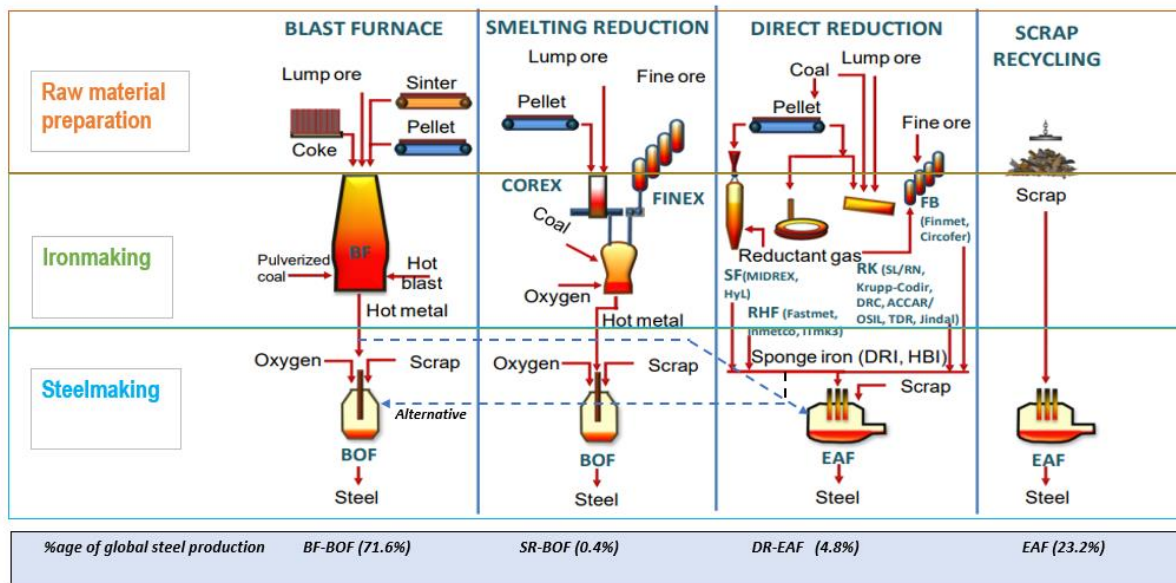

Figure 1:- Steel making processes.

4.1 Blast Furnace-Basic Oxygen Furnace

71.6 % of the world steel is produced by blast furnace-basic oxygen furnace (BF-BOF) route. In the blast furnace, iron ore (iron oxide) is reduced to iron. Iron oxide is fed into the furnace as “lump” or as sintered or pelletised fines. Carbon is introduced to the furnace as coke (top feed) or pulverised coal (as tuyere injectant). In the furnace, the carbon reacts with the oxygen in the “blast” air to produce carbon monoxide, which is the major reductant in the furnace, and provides the energy for the reduction reactions. Iron ore normally contains materials such as silica (SiO₂), Alumina (Al₂O₃) along with Sulphur (S) and Phosphorus (P). Removal of these impurities is done by combining these materials with CaO and/or MgO to form slag which consists of low melting point complex compounds. The molten iron from BF is also known as pig iron. Blast Furnace Gas (BFG) is the off gas from the blast furnace operation. The coke required for the blast furnace is produced in coke ovens. The off gas from coke ovens is called Coke Oven Gas (COG).

Basic oxygen furnace (BOF) converts molten iron into steel. In this process, pure oxygen (normally from an Air Separation Unit (ASU)) is blown through the molten iron to combust carbon remaining in the iron. This reduces the carbon content from around 4 % to less than 1 %. Lime is added to produce slag. Scrap and recycled steel can be added to help maintain the temperature within the BOF. It is very common to use recycled and scrap steel in BOF to increase output and reduce CO₂ emissions. The off gas from the BOF operation is known as Basic Oxygen Furnace Gas (BOFG) or Linz Donawitz Gas (LDG).

4.2 Electric Arc Furnace

Steel production in electric arc furnaces (EAF) is almost completely based on scrap steel that facilitates recycling of steel to make new steel. Currently, around 20% of steel in Australia, and around 23% of the total global steel is produced by EAF. In the electric furnace, electrical energy is provided via graphite electrodes to melt the scrap. Recycled steel accounts for significant energy and raw material savings including over 1400 kg of iron ore, 740 kg of coal and 120 kg of limestone saved for every 1000 kg of steel scrap made into new steel [14]. However, the production of steel through EAF is severely limited by availability of scrap steel and potential impacts to the steel quality.

4.3 Direct Reduction

Direct reduced iron (DRI), also known as sponge iron and is produced through the direct reduction of iron ore. Around 5% of the total world steel is produced by DRI process. In the DRI process, the iron ore is pelletized prior to direct reduction process. Direct Reduction technology allows for coke-free iron making production and consists of gas based and coal-based reduction process, with gas-based DR iron production being the dominant technology. Around 90% DR is performed using Natural Gas (NG) as a source for reducing agent. The leading DRI producing countries are India, Venezuela, Iran and Mexico.

MIDREX iron making process is based on direct reduction of iron (DRI) is a solid state reduction process which reduces iron ore pellets or lump ore into DRI without them melting. The shaft furnace is the key component of the process in which ore is fed into the top and descends by gravity, and is reduced by the up flowing reducing gas, which is mainly hydrogen and carbon monoxide. Reducing gas is externally generated by reforming natural gas or by coal gasification. The first commercial plant based on MIDREX was built in 1969 in Portland Oregon USA.

5. Energy & Emission Intensity

In the current project, the focus is on steel making from the BF-BOF processes in an integrated steel plant. The Port Kembla integrated steel plant consists of raw material handling, including sinter production, coke making, ironmaking, steelmaking and steel re-heating and rolling. These primary steelmaking processes are supported by ancillary operations, including oxygen, nitrogen and argon production, steam generation to facilitate the production of compressed air and electricity generation, and provision of cooling water.

Raw materials include coal, iron ore, limestone, dolomite and metal alloys.

5.1 Energy Intensity

Iron and steel making are energy intensive processes. During last 60 years, implementation of energy management systems and improvement in energy efficiency have led to a reduction of about 60% in the energy requirement for steel production as shown in Figure 2. Although the energy intensity of steel making has fallen gradually, the total energy consumption of steel industries is rising due to increasing demand for steel.

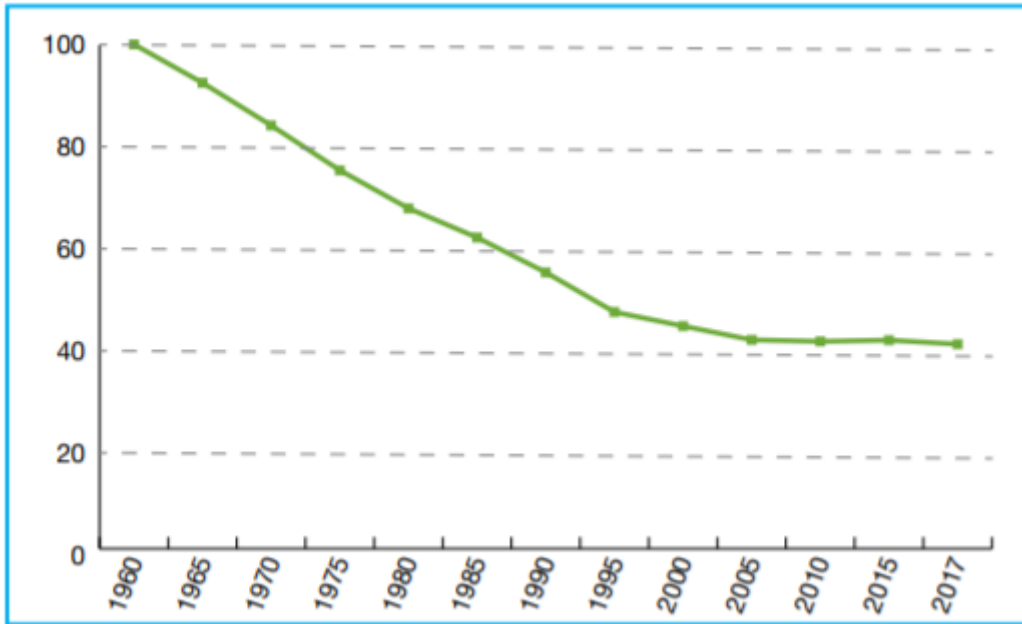

Figure 2: Indexed global energy consumption/tonne of crude [3].

Figure 3 shows the total energy consumption and energy intensity of iron and steel industry from the year 2000 onwards. A total of 33.44 EJ (1 EJ =10⁹ GJ) of energy was consumed by global steel industry in 2017 which is equal to 5.9% of the global energy demand of 566 EJ [15, 16].

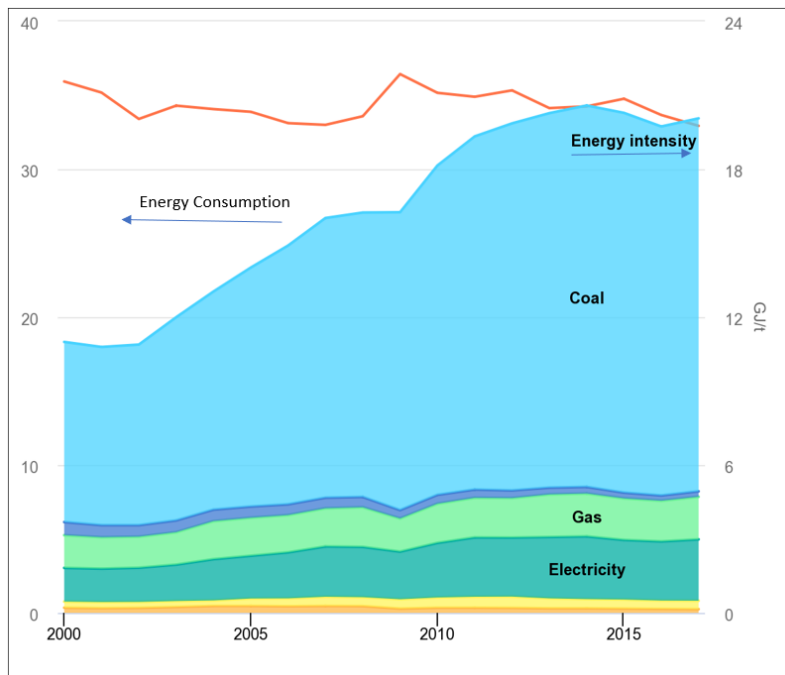

Figure 3: Energy demand and intensity of iron and steel making [15].

As shown in Figure 3, in 2017 the energy intensity of steelmaking was 19.76 GJ/t of steel. According to IEA, the fall in energy intensity is mainly due to increased scrap-based production and energy efficiency improvements [15]. Switching from open hearth to basic oxygen furnace for converting iron to steel, pelletizing or sintering blast furnace feed, increased availability of BOF, adoption of continuous casting which eliminated ingot reheating in the slab mill are the other factors contributing in reduction of energy intensity of steel making. However, as shown in Figure 2, after the year 2005, the energy intensity curve has become asymptotic.

5.2 Emission Intensity

The steel industry is the single largest source of industrial CO₂ emissions. As shown in Figure 4, the share of CO₂ emissions towards industrial emissions is gradually increasing since 2005. In 2017, the total industrial emissions was around 23% of the total global emissions with steel industry emissions of ~6% [17]. CO₂ emissions from an iron and steel plant can be divided into two categories [18]: Scope 1 and Scope 2 emissions.

- Scope 1 greenhouse gas emissions are the emissions released to the atmosphere as a direct result of an activity, or series of activities at a facility level. Scope 1 emissions are sometimes referred to as direct emissions. For example, in steel production, Scope 1 CO₂ emissions are due to fossil fuel and raw materials used in the iron and steel making process. These include coal, limestone, dolomite and natural gas.
- Scope 2 greenhouse gas emissions are the emissions associated with the indirect consumption of an energy commodity. For example, 'indirect emissions' come from the consumption by Bluescope of electricity produced in another facility. Scope 2 emissions attributed to one facility are part of the scope 1 emissions from another "upstream" facility.

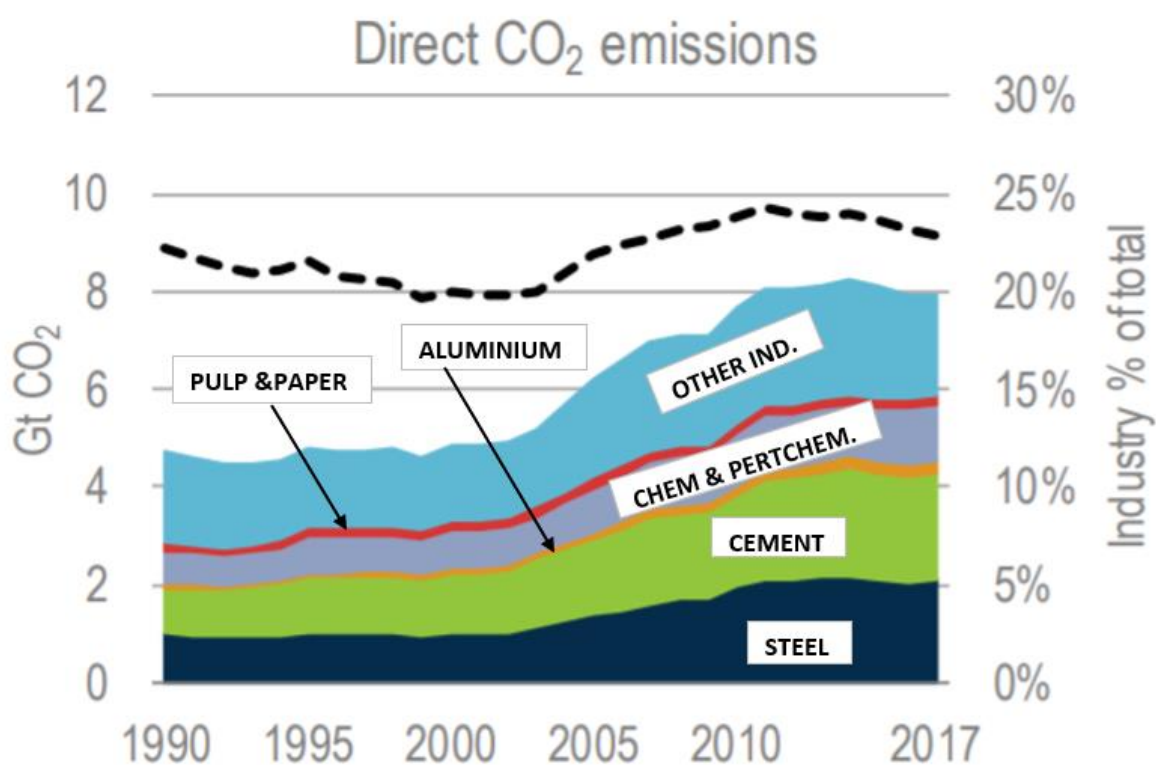

Figure 4: Global industrial direct CO₂ emissions [17]

CO₂ emission intensity is Scope 1 and 2 greenhouse gas emissions from steel-making, per unit of crude steel produced, in units of (metric) tonnes of CO₂ equivalent per tonne of crude steel.

In the steel industry, carbon emissions depend on the type of fuel, fuel mix and process modifications. Therefore, energy intensity trends do not always match with the carbon emission trends. In 2017, the steel industry accounted for 21% of total industrial energy use and 24% of industrial direct CO₂ emissions [19]. As shown in Figure 5, the emission and energy intensity vary from region to region and depend on the quality of raw materials (iron ore & coal) used and the cost of energy. In addition,

technology and plant size also play a role in energy and emission intensity of a steel plant. For example, Figure 5 shows the average CO₂ intensity for India and China is higher than the world average [20] due to use of local low quality coal.



Figure 5:- Region wise Direct CO₂ intensity of steel production

The International Energy Agency (IEA) regularly tracks the global emissions and provides future projections under different scenarios. IEA’s 2 Degrees scenario (2DS) is based on limiting the global average temperature to well below 2°C above pre-industrial levels. 2DS is consistent with the overall aim of the Paris Agreement to hold “the increase in the global average temperature to well below 2°C above pre-industrial levels and to pursue efforts to limit the temperature increase to 1.5°C above pre-industrial levels.” However, it has been established that the total amount of the emissions reductions pledged to the Paris Agreement is not sufficient to limit global warming to 2°C.

Figure 6 shows the emissions intensity paths for the steel sector under the 2DS scenario and Paris Agreement [21, 22]. Currently the global steel is performing better than the requirements of 2DS. However, as seen in Figure 6, year 2020 is the inflection point. To meet 2DS, a steeper cut in emissions is required.

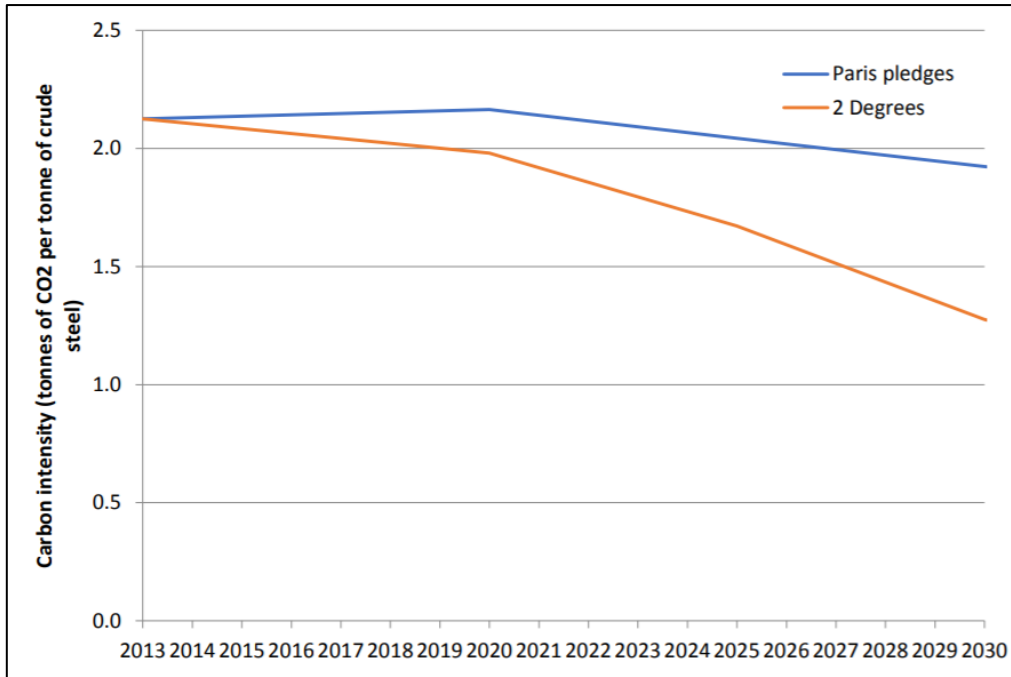

Figure 6:-CO₂ emission intensity path for steel industry

GHG emissions is among 8 sustainability indicators that steel companies report voluntarily every year since 2004 to the World Steel Association. In 2018, 97 steel companies including BlueScope Steel reported one or more sustainability indicators for the year 2017. These companies produced 56.9 % of global steel in 2017. Figure 7 shows the performance trend of sustainability indicator of GHG emission[23]. The average GHG emission intensity for the year 2017 is 1.83 tonnes CO₂ per tonne of crude steel cast. This value is lower than the reported Scope 1 GHG emission of BlueScope for the year 2018. However, the performance numbers in Figure 7 are average CO₂ intensities for a number of steel production routes: BF/BOF, EAF, BF/OHF and DRI/EAF. For an integrated steel plant, the CO₂ intensity is greater than the values shown in Figure 7. BlueScope’s reported Scope 1 emission is among the top 35% best performers utilizing the BF/BOF production route.

Indicator 1: Greenhouse gas emissions

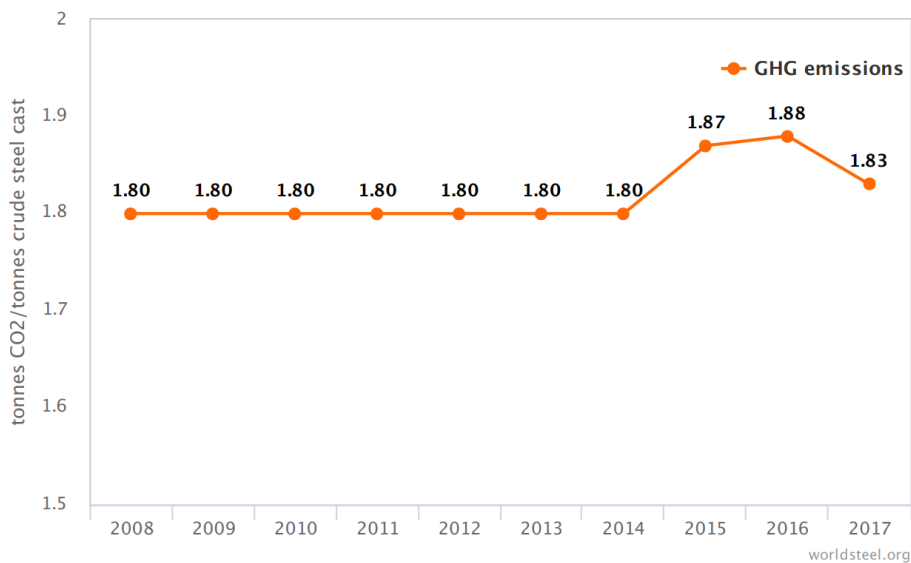

Figure 7:- GHG emission trend based on average of voluntarily reported GHG emissions by steel companies (World Steel Organization)

6. Australian Steel Industry

Steel production in Australia started in 1901 when the first blast furnace became operational at Lithgow NSW. In 1915 BHP opened its steel mill in Newcastle NSW based on locally mined coal and iron ore from South Australia. Steel production in Australia peaked to 10 million tonnes in 1981. In 2017, Australia's steel production was 5.3 million tonnes, which is around 0.3% of the global steel production of 1689 million tonnes [8].

Currently, there are two major steel producers in Australia; BlueScope Steel and InfraBuild (Formerly Liberty OneSteel/Arrium Steel). Both were formerly part of BHP Limited. They produce crude steel domestically, although they produce different products to each other. BlueScope Steel's Port Kembla Steelworks uses the blast furnace/basic oxygen furnace process route and has an annual production capacity of 3.0 million tonnes [39]. InfraBuild produces steel from both blast furnace/basic oxygen furnace and electric arc furnace processes. Its Whyalla Steelworks has an annual production capacity of ~1.2Mtpa of steel using blast furnace/basic oxygen furnace Steelmaking process [40]. In 2017, around 80% of the steel produced in Australia was with blast furnace/basic oxygen furnace process and 23% was with electric arc furnace process where as the global figure for these are 71.6% and 28% respectively.

The steel industry in Australia has a significant role in Australia's economy. According to the Australian Steel Institute, the Australian steel industry includes all iron and steel manufacturing, fabrication and casting activities and has an annual turnover of A\$ 29 billion, with around 135,000 jobs and contributes A\$ 11 billion to Australia's GDP[41].

6.1 Initiatives of Australian Steel Industry

6.1.1 Biomass in Steel Production

In 2006, collaboration work commenced between Australia's two major steel companies, Arrium (formerly OneSteel) and BlueScope Steel, and the CSIRO under the Australian Steel Industry CO₂ Breakthrough Program. The two technologies developed under this program are application of biomass-derived chars in ironmaking and development of dry slag granulation (with heat recovery).

A comprehensive forest to steel biomass technology has been demonstrated successfully at a laboratory scale producing a promising result in significant CO₂ emission reduction. By substituting coke from coal with charcoal from biomass, low carbon steel making process is achievable. The research also concluded that Australian resources can produce 1Mt/y of charcoal, at a cost comparable with coal/coke [24].

Table 1 and Table 2 show the proposed applications for biomass-derived chars in a typical Australian integrated and EAF process respectively. The potential CO₂ emission reduction to utilise biomass in the BF-BOF integrated route is significant (32-58%), with greatest reduction via the application of BF tuyere injectant. On the other hand, the CO₂ emissions savings from the EAF route are low with biomass application, as majority (78%) of its associated emission sources are from the electricity generation [25].

Table 1: Biomass based char for a typical Australian integrated steel making operation

Application	Basis	Net Emissions Reduction	
		t-CO ₂ /t-crude steel	% of CO ₂ Emissions
Sintering solid fuel	50 – 100% replacement of coke breeze or anthracite at 45 – 60 kg-coke/anthracite / t-sinter (and 1.7 t-sinter/t-HM)	0.12 – 0.32	5 – 15
Cokemaking blend component	2 – 10% of coking coal blend, with coke used at 300 – 350 kg-coke / t-HM	0.02 – 0.11	1 – 5
BF tuyere fuel injectant	100% replacement of injected coal (PCI) at 150 – 200 kg-coal / t-HM	0.41 – 0.55	19 – 25
BF nut coke replacement	50 – 100% replacement of 45 kg-nuts / t-HM	0.08 – 0.16	3 – 7
BF carbon/ore composites or BOF pre-reduced feed	5 – 10% of iron in charcoal/ore pellets to BF or charcoal-based pre-reduced feed to BF or BOF.	0.08 – 0.15	4 – 7
Steelmaking recarburiser	100% replacement of 0.25 kg-char / t-crude steel	0.001	0.04
Totals		0.70 – 1.26	32 - 58

Notes: HM is hot metal
PCI is Pulverised Coal Injection
PCI coal assumed to be 75% C
Coke, coke breeze, anthracite and recarburiser are assumed to be 85% C

Table 2: Biomass based char for a typical Australian EAF steel making operation

Application	Basis	Net Emissions Reduction	
		t-CO ₂ /t-crude steel	% of CO ₂ Emissions
Charge carbon	50 – 100% replacement of 12 kg-coke / t-crude steel	0.019 – 0.037	3.8 – 7.5
Raw materials, electrodes, etc	0% replacement of 4.5 kg-C / t-crude steel	0 (of 0.017)	0 (of 3.5)
Natural gas heating	0% of 3 Nm ³ /t-crude steel (0.54 t-C / t-crude steel)	0 (of 0.002)	0 (of 0.5)
Slag foaming agent	50 – 100% replacement of 5 kg-coke / t-crude steel	0.008 – 0.016	1.6 – 3.1
Steel recarburiser	50 – 100% replacement of 1.4 kg-char / t-crude steel	0.002 – 0.004	0.5 – 0.9
Totals		0.029 – 0.057	5.9 – 11.5

Notes: Coke, foaming agent and recarburiser assumed to be 85% C
No improvements in electrical usage are considered here.

Based on a global assessment of biomass suitability for ironmaking [26] with consideration of all-inclusive factors of steel production, bioenergy and policy, Australia scored highly for suitability of integrating bioenergy into the steel industry. However, due to Australian's extensive coking coal resources, the low cost of coal (US\$90 per metric tonne) in comparison to the high cost of charcoal (US\$386 per metric tonne) poses a barrier for biomass deployment into the Australian steel industry.

Currently, only Brazil has full scale industrial practise utilising biomass technology in steelmaking. Brazil is the largest wood-based charcoal producer, and majority of the charcoal is used by the steel industry (mini blast furnace) [26].

6.1.1.1 Bioenergy at BlueScope

BlueScope Steel has done extensive research on the combustion behaviour of bio-char and PCI coals, the finding shows that the combustion performance of charcoals greatly exceeded those typical for coals at the same volatile matter content [25]. This combustion study has indicated very favourable performance to deploy biomass application in large blast furnaces subject to suitable supply economics and continued success in R&D phase.

Despite the hurdles noted above, the potentially significant CO₂ emission reductions that could result from the utilization of biochar has resulted in BlueScope's decision to further investigate this option as part of ongoing actions to reduce carbon emissions at its Port Kembla Steelworks.

The main focus of this investigation is the potential part replacement of coal with biochar for blast furnace tuyere injection, which will also require further work to develop supply chains for biomass and biochar.

The original investigation looked at sourcing biomass feed through sustainably produced timber from forestry operations. The current investigation is expanding this to consider waste timber from the construction and demolition sectors, a significant proportion of which is destined for landfill.

This further investigation of the biochar option is in the early stages and has a number of barriers to overcome. The biggest of these is there is no current supply chain in Australia for the larger quantities of biochar required for industrial trials. The smaller capacity of current commercially available pyrolysis processes and the logistical complexities associated with the supply and transport of biomass and biochar are other challenges that will also need to be overcome.

A further barrier is a regulatory one, requiring acceptance by the Clean Energy Regulator that waste wood (both forestry and commercial / industrial), along with appropriately managed plantation timber, is carbon neutral and therefore its carbon content does not need to be accounted for in the feed to the ironmaking process.

6.1.2 Dry Slag Granulation

CSIRO Australia with industry partners Arrium and BlueScope has developed Dry slag granulation (DSG) technology for the blast furnace. DSG blast furnace has a spinning disc and granulation chamber, to convert molten slag into droplets under centrifugal forces. Air is used to quench and solidify the droplets, extracting a granulated slag product and heated air. The air can be utilised for drying, preheating or steam generation within the steel plant. CSIRO has formed an agreement with Beijing MCC Equipment Research & Design Corporation (MCCE), that will see the Chinese company trial CSIRO's Dry Slag Granulation (DSG) technology on an industrial scale. If MCCE's use of DSG on an industrial scale is successful then the technology will be commercialised in China which produces 60% of global blast furnace slag [27].

DSG has global potential of saving 60 billion litres of water, 800 petajoules of heat energy and 60 million tonnes of greenhouse gas emissions each year with full commercialization [28].

6.1.3 Polymer Injection Technology

The University of New South Wales (UNSW) in partnership originally with One Steel (now Liberty Steel) then with Newcastle-based steelmaker MolyCop developed Polymer Injection Technology. Rubber and carbon black are the main constituent of a tyre. The process based on this technology uses old rubber tyres as a replacement for coking coal, a source of carbon that is vital in steelmaking. This technology has been commercialized in Australia, South Korea, Thailand, UK and Norway.

In this process, the tyres are shredded to pieces of less than 5 millimetres in size after removing their steel rims. The shredded material is then directly injected into the furnace where it reacts with iron oxide to make the iron needed for the steel. In the furnace which has temperature of around 1550 °C, the tyre shreds react extremely fast. It breaks down into small molecules, and the noxious products that are produced when tyres are combusted at lower temperatures don't form. The small molecules also efficiently progress the reduction reaction needed to convert the iron oxide into iron. The process exploits both gaseous and solid forms of carbon, leading to a better the efficiency of the process. The process can use other types of plastic polymers [29].

6.1.4 Outcome of Sustainability Initiatives by Australian Steel Industry

According to the Australian Steel Institute (ASI) various initiatives to reduce the environmental impact of steelmaking by Australian steel manufacturers have resulted in significant gains in reduction of

greenhouse gas emissions, water savings and sustainable use of steelmaking by-product. ASI's webpage[30] has highlighted the following outcome throughout the value chain of steel.

- A significant reduction in greenhouse gas is being achieved through turning waste products into valuable by-products. The Liberty Steel plant in Whyalla, South Australia, currently generates more than 35% of its own electricity requirement through the efficient reuse of waste gases.
- BlueScope Steel reports a reduction in carbon emissions of over 40% since 2011 and an 8% reduction in emissions intensity per tonne of steel.
- In 2017, BlueScope Steel's Port Kembla Steelworks has reported reduction in water consumption in steelmaking from over 5.0 to 2.5 kl per tonne of slab over the past 10 years.
- Collieries supplying coal to Port Kembla Steelworks are now using coal seam methane gas (which is 20 times more potent than CO₂ as a greenhouse gas) to produce electricity.
- Spent acid from sheet and coil galvanizing and pickling processes are being used in fertiliser production.

BlueScope participates in the World Steel Association's CO₂ Climate Action program, submitting annual operational data for our three steelmaking facilities. BlueScope has made sustained improvements in energy and emissions intensity for a number of years.

No. 22 Turbo Alternator at Port Kembla Steelworks, was built using redundant equipment, relocated from other parts of the plant, that was still in good condition and with remaining life. The project resulted in increased internal generation of electricity using by-product fuels and 7.4 per cent reduction in purchased electricity from the grid, equivalent to 46,000 tonne CO₂-e per annum.

In FY2018, BlueScope concluded an energy strategy review for its Australian operations. A seven-year, 233,000-megawatt hour (MWh) per annum Power Purchased Agreement was signed with ESCO Pacific for a new 500,000 panel solar farm at Finley, New South Wales. This is equivalent to 20 per cent of BlueScope's Australian purchased electricity demand. The use of renewal energy will avoid 0.3 MTPA CO₂-eq and shows BlueScope's commitment to support the decarbonisation of the electricity supply sector.

7. Initiatives for Reducing Emissions in Steel Production

According to IEA, during 2010 to 2016, average decline in the CO₂ intensity of crude steel was 1.4%. In 2017 the CO₂ intensity fell by 1.8% [15]. IEA's Sustainable Development Scenario (SDS) meets the global temperature conditions of Paris agreement. To align with the SDS, the CO₂ intensity of crude steel production needs to fall by 1.9% annually between 2017 and 2030. This decrease is especially important as the emission intensity has increased to 1.85 in 2018 from 1.83 tonnes CO₂/tonne CS and global steel demand continues to grow. According to World Steel Association (WSA), it is crucial to develop breakthrough technologies to achieve drastic reduction in CO₂ emission from steel production [4]. WSA has categorized these technologies as follows:

- **Hydrogen as a reducing agent** – Use of hydrogen in place of coke to reduce iron ore for CO₂ free reduction process.
- **Carbon Capture and Storage (CCS)** – Capture CO₂ from flue gases by retrofitting steel plants with suitable capture technology develop transportation networks and access to CO₂ storage sites.
- **Carbon Capture and Utilisation (CCU)** - Uses the components of the co-product gases from existing processes to produce fuels or input material for the chemical industry.

- **Biomass as a reducing agent** – Partially substitute coke with biomass-based char.
- **Electrolysis** – Reduces iron ore using electricity.

IEA has stressed the need for innovations to reduce emissions beyond the level that can be achieved by energy efficiency and scrap-based production and listed the following areas where innovation gap exists.

- New smelt reduction technologies based on coal or hydrogen plasma can cut emissions from coke production.
- Direct reduction technologies based on natural gas, hydrogen or electricity.
- Integrating CCS into existing iron and steel technologies.
- Using steel mill gases for chemical and fuel production through carbon capture and utilization.

It can be observed that both WSA and IEA recommendations are very similar. Both the organizations have underlined the significance of hydrogen, CCS and CCU to reduce emissions from steel production and recommended the innovation and development initiatives in these areas.

Table 3: Major CO₂ reduction initiatives worldwide

Programme	Participants	Innovative Technologies
ULCOS	All major EU steel companies, energy and engineering partners, research institute and universities. Also supported by the European Commission	-Top Gas Recycle Blast Furnace with CCS -HISARNA with CCS -ULCOWIN and Ulcolysis -ULCORED with CCS
AISI	Public private partnership between AISI and the US Department of Energy (DOE), Office of Industrial Technology	-Molten oxide electrolysis -hydrogen flash smelting
COURSE50	Japan Iron and Steel Federation (JSF), Japanese Ministry of Economy, Trade and Industry	-CCS -Reduction of iron ore with hydrogen
POSCO	POSCO, RIST, POSLAB, POSTECH	-CCS using excess heat and ammonia -CO ₂ fixation using marine bio-slag -hydrogen production from by-product gas from the steel making process -heat recovery from sintered ore -carbon lean FINEX process
Baosteel	Baosteel	-photovoltaic cells -CCUS ethanol production from BOF gas (Lanza Tech)
CSC	Taiwan CCS Alliance coordination	-CO ₂ purification via the oxy fuel burner -Energy use reduction -BOF slag carbonation and microalgae -carbon fixation
Australia	BlueScope Steel and One Steel, CSIRO coordination (Australia)	-CO ₂ emission reduction by using biomass and by-product -dry slag granulation
CPSA & Brazil		Biomass-based steel production
Steelanol [31]	Arcelor Mittal, LanzaTech.	Ethanol from steel mill off gases using biochemical process (CCUS)
HYBRIT[32]	SSAB, LKAB and Vattenfall (Sweden)	Replacing coking coal with Hydrogen
Carbon2 Chem[33]	Thyssenkrupp AG (Germany)	Value added chemicals from steel mill gases Haber Bosch process for making ammonia Catalytic process for making Methanol (CCUS)

STEPWISE [34]	European Union, SSAB, Foster Wheeler Italy, Tata Steel Consulting, Johnson Matthey	Advanced Pre-Combustion CO ₂ removal from BFG by using water gas shift reaction (WGS) and Sorption Enhanced Water-Gas Shift technology (SEWGS)
Abbreviations ULCOS (Ultra-Low Carbon Dioxide Steelmaking) AISI (American Iron and Steel Institute) COURSE50 (CO ₂ Ultimate Reduction in Steel Making Process by Innovative Technology for Cool Earth 50) POSCO (CO ₂ Breakthrough Framework Programme) Baosteel (China Baosteel Programme) CSC (China Steel Corporation-Taiwan) Australia (Australian Steel Industry CO ₂ Breakthrough Programme) CPSA (Canadian Steel Producers Association) Brazil (Arcelor Brazil)		

Table 3 lists the major initiatives for reducing CO₂ emissions from steel production. The table reveals focus on CCS/CCUS, use of hydrogen & biomass in steel making and energy reduction. These are consistent with the recommendations of WSA and IEA as discussed above. IEA/WSA has compiled all the new and innovative technologies and presented in the form of Figure 8 [19]

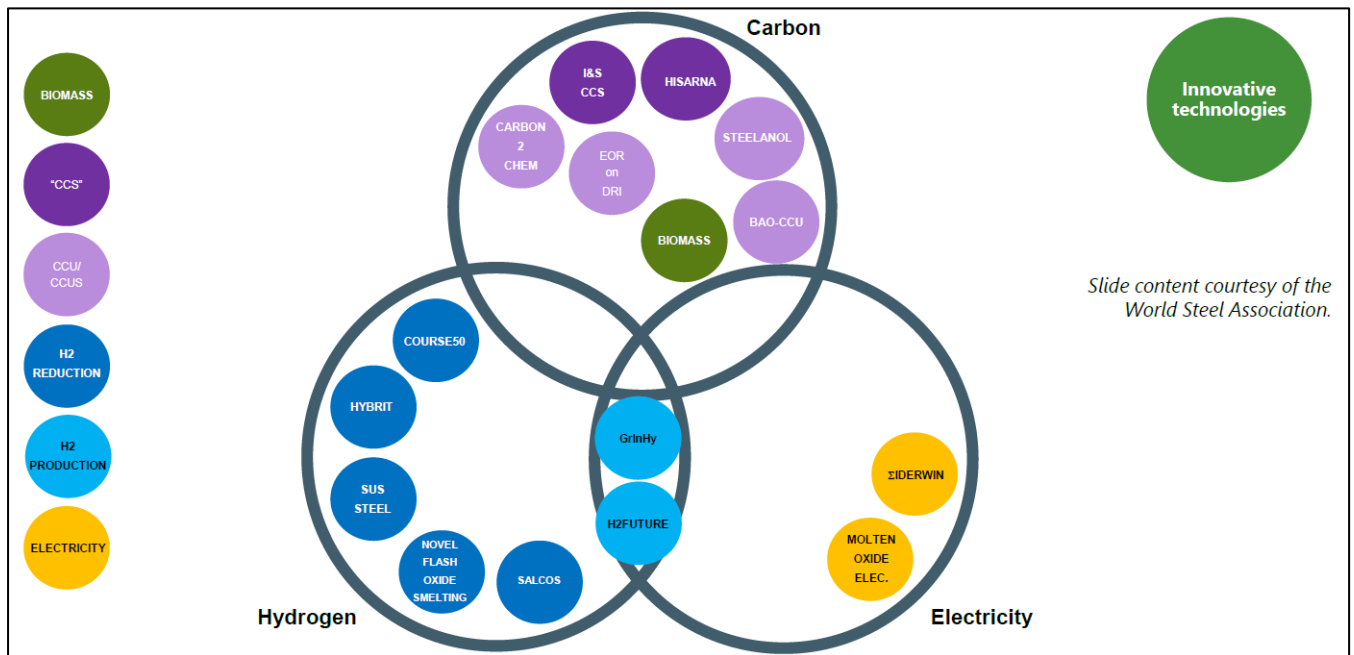

Figure 8:- Innovative technologies for CO₂ reduction in steel production

7.1 ULCOS

The ULCOS programme is a consortium of European Steel and allied industry aiming to achieve at least 50% reduction of GHG emissions. It is the most extensive research programme, consisting of two phases: ULCOS I in 2004 and ULCOS II in 2010. There are four main CO₂ breakthrough technologies developed under ULCOS, that are ULCOS-BF, HISARNA with CCS, ULCORED with CCS, ULCOWIN & ULCOLYSIS (electrolysis). Demonstration plant or commercial deployment have been achieved to date, as shown in [35].

7.1.1 Top Gas Recycle Blast Furnace (TGR-BF)

This technology is also known as “Nitrogen Free Blast Furnace (NFBF)” or “Oxy-Blast Furnace (OBF)”. The concept of the TGR-BF involves many technologies which include

- (i) injection of reducing top gas components CO and H2 in shaft and hearth tuyeres,
- (ii) lowering the consumption of fossil C input due to lower coke rate,
- (iii) usage of pure oxygen instead of hot air at the hearth tuyere (removal of nitrogen from the process),
- (iv) recovery of pure CO₂ from the top gas for underground storage using vacuum pressure swing adsorption.

This technology as shown in Figure 10 has been first deployed and tested successfully at LKAB’s Experimental Blast Furnace (EBF) in Lulea, Sweden at 36t/day. The EBF was later modified with VPSA carbon capture plant by Air Liquide built near the EBF. The technology of TGR-BF combined with VPSA CCS technology demonstrated up to 24% CO₂ reduction by TGR-BF technology and 52 % CO₂ reduction by VPSA technology during the reference period [35].

Technology	Programs	Main advantages compared to reference	Potential drawbacks compared to reference	Technological Maturity prediction
ULCOS-BF (Top gas recycling) With CCS	FP6 ULCOS	50% CO ₂ reduction compared to average blast furnace	Higher operational costs	2010: Pilot phase Demonstrator 2020: Commercial deployment
	RFCS ULCOS RFCS IDEOGAS RFCS TGR-BF Green BF	Expected to be the standard for newly built plants (retrofit option)		
Hlsarna (Coke free steelmaking) with CCS	FP6 ULCOS	80% CO ₂ reduction compared to average blast furnace with CCS, 20% without CCS.	Needs replacement of existing blast furnaces	2020: Pilot phase demonstrator 2030: Commercial deployment
	Hlsarna RFCS	Lower investments and operational costs due to broader range of available inputs		
ULCORED (Fastmelt process of direct reduction)with CCS	FP6 ULCOS	55% CO ₂ reduction compared to average blast furnace with CCS, 5% without CCS	Essentials replacement of existing blast furnaces	2015: Pilot phase demonstrator 2020: Commercial deployment
	ULCORED RFCS	Lower operational costs due to broader range of available inputs	Higher investment costs	2030: Pilot phase demonstrator
Electrolysis (ULCOWIN & ULCOLYSIS)	FP6 ULCOS	Probably no carbon is needed in the production process		
	RFCS IERO			
	ANR ASCOPE			
	Auto thermal cell			
H ₂ Reduction	FP6 ULCOS Further work...			2010: not developed
Use of sustainable biomass	FP6 ULCOS Further work...			Not developed

*RFCS (Research Fund Coal Steel) *FP6 (EU's 6th Framework Programme).

Figure 9: Summary of ULCOS Project

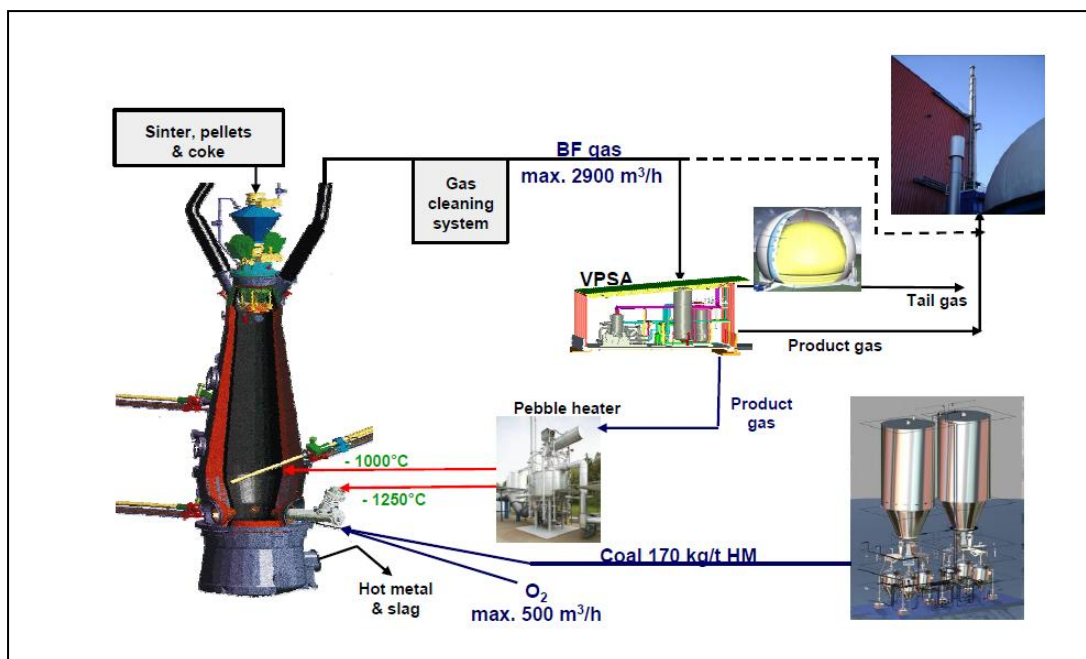

Figure 10: The ULCOS TGR-BF Concept in Lulea [36]

7.1.2 HISARNA

HISARNA is a bath-smelting reduction technology that removes sintering and coking processes, the major contributors to CO₂ emissions, from conventional smelting technology. HISARNA combines coal preheating and partial pyrolysis in a reactor, Figure 11 shows the simplified diagram of HISARNA technology. Study shows that 70% reduction in CO₂ emission is achievable with HISARNA technology together with the replacement of coal (using biomass or natural gas), CCS and waste heat recovery[35].

Three technologies have been developed as below:

- Cyclone Converter Furnace (CCF) for ore-prereduction step.
- HISMELT for the smelting of pre-reduced ore.
- Production of char from the pyrolysis of coal as feedstock to smelter.

Fine ores are fed into the CCF (top portion of vessel) where melting and pre-reduction of ore take place. Oxygen is injected into the CCF and smelter vessel to burn any combustible gas to produce partially melted ore. The partially melted ore in the CCF is then separated from the gas via centrifugal motion in the melting cyclone, producing CO₂ and CO from the top of the cyclone, whilst the ore drops into the smelter bath at the bottom of the cyclone. Char is injected into the bath for final reduction by contacting the pre-reduced ore with carbon. The hot metal and slag are produced from the bottom of the smelter vessel.

The gas leaving the top of the HISARNA reactor is cleaned via de-dusting, sulphur removal, gas dehydration and waste heat recovery to produce clean dry gas containing 90-95% CO₂, which is sent to a cryogenic process and compressed prior to its delivery to the pipeline [37]. Simplified schematic for HISARNA with CCS is shown in Figure 11.

HISARNA technology has been deployed successfully at an 8 tonne/d pilot plant built by TATA Iron and Steel Group at Ijmuiden, Holland in 2010. In 2011, a demonstration plant for HISARNA technology

without CCS was built in Ijmuiden. The next stage of industrial scale demonstration, in October 2017, a six-month test campaign was carried out proving that liquid steel can be produced with long running hours. After successful campaign at Ijmuiden in 2018, Tata Steel announced the decision to make the new large-scale pilot plant of 400,000 tonne/year capacity in Jamshedpur, India [35, 38].

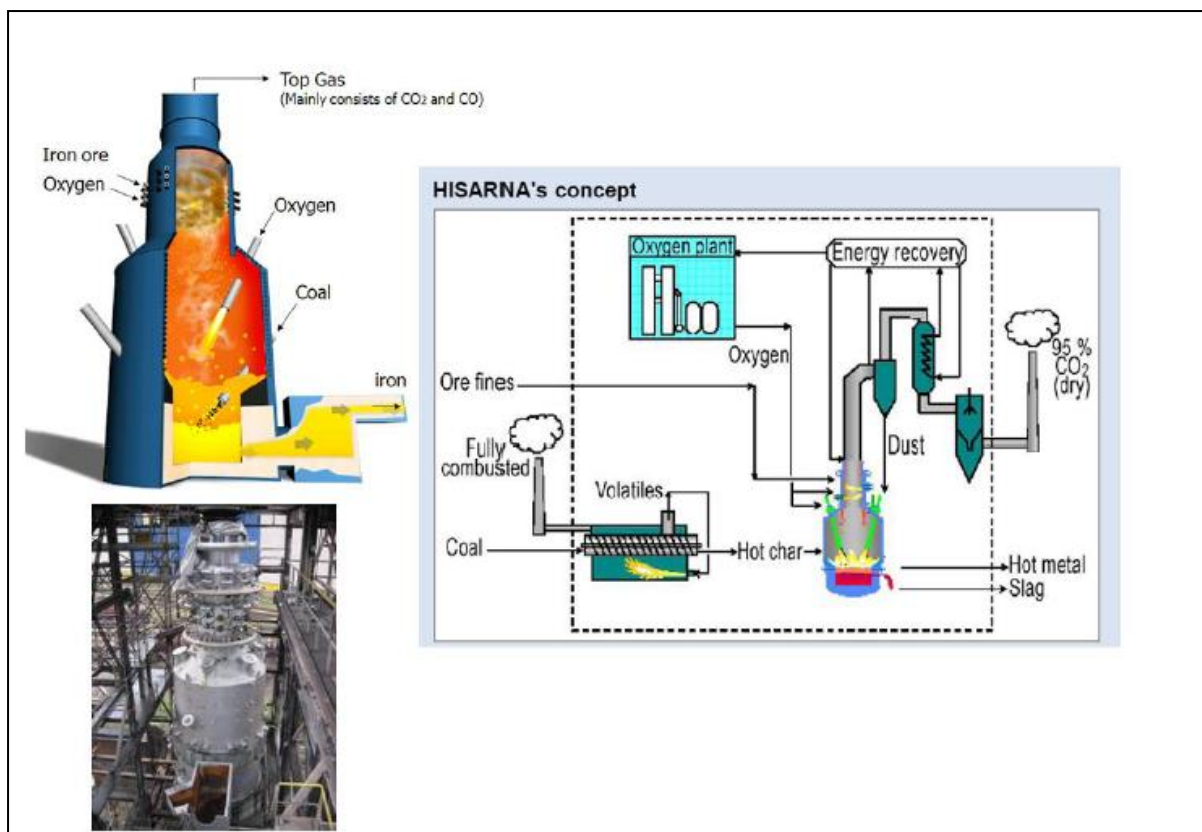

Figure 11: Simplified Diagram on HISARNA technology and the pilot plant at IJmuiden Steel work

7.2 HYBRIT

HYBRIT is an initiative started in 2016 from SSAB, LKAB and Vattenfall (SWEDEN) to replace coking coal with hydrogen for steel making. The aim is to develop world's first fossil-free steel-making technology, with virtually no carbon footprint. In 2018 work started on the construction of a globally-unique pilot plant for fossil-free steel production at the SSAB site in Luleå, Sweden. The Swedish Energy Agency has contributed SEK 60 million to the pre-feasibility study and a four-year-long research project. The total cost for the pilot phase is estimated to be SEK 1.4 billion. HYBRIT is a unique project and the first of its kind. If the project succeeds, it will contribute to Sweden's national climate goal, to be fossil-free by 2045.

The key component of this process is to remove the oxygen from iron ore not by using coke (from coal) but instead with hydrogen gas, H₂. With this process, the by-product of creating iron isn't carbon dioxide – it's water. The basic reaction in HYBRIT is shown in Figure 12.

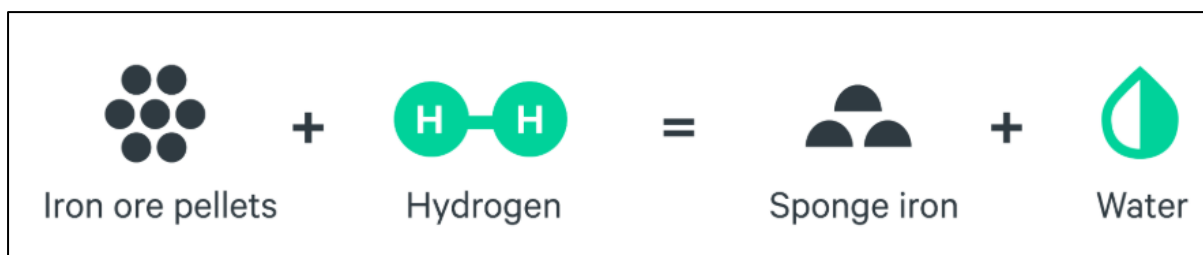

Figure 12: Basic reaction in HYBRIT (Courtesy- HYBRIT)

Figure 13 shows the timeline for HYBRIT and Figure 14 shows the process comparison of conventional blast furnace route and HYBRIT route [39].

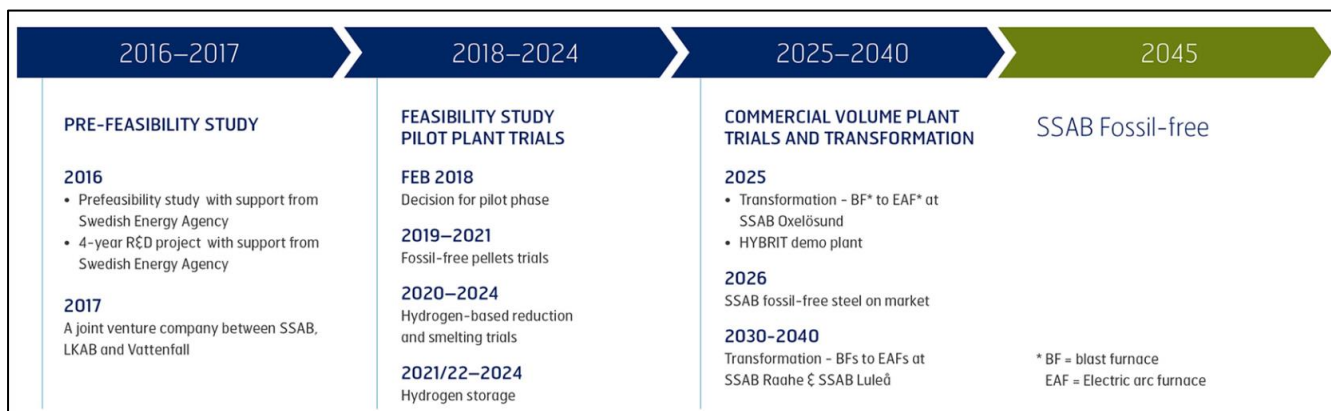

Figure 13:- Time line for HYBRIT project

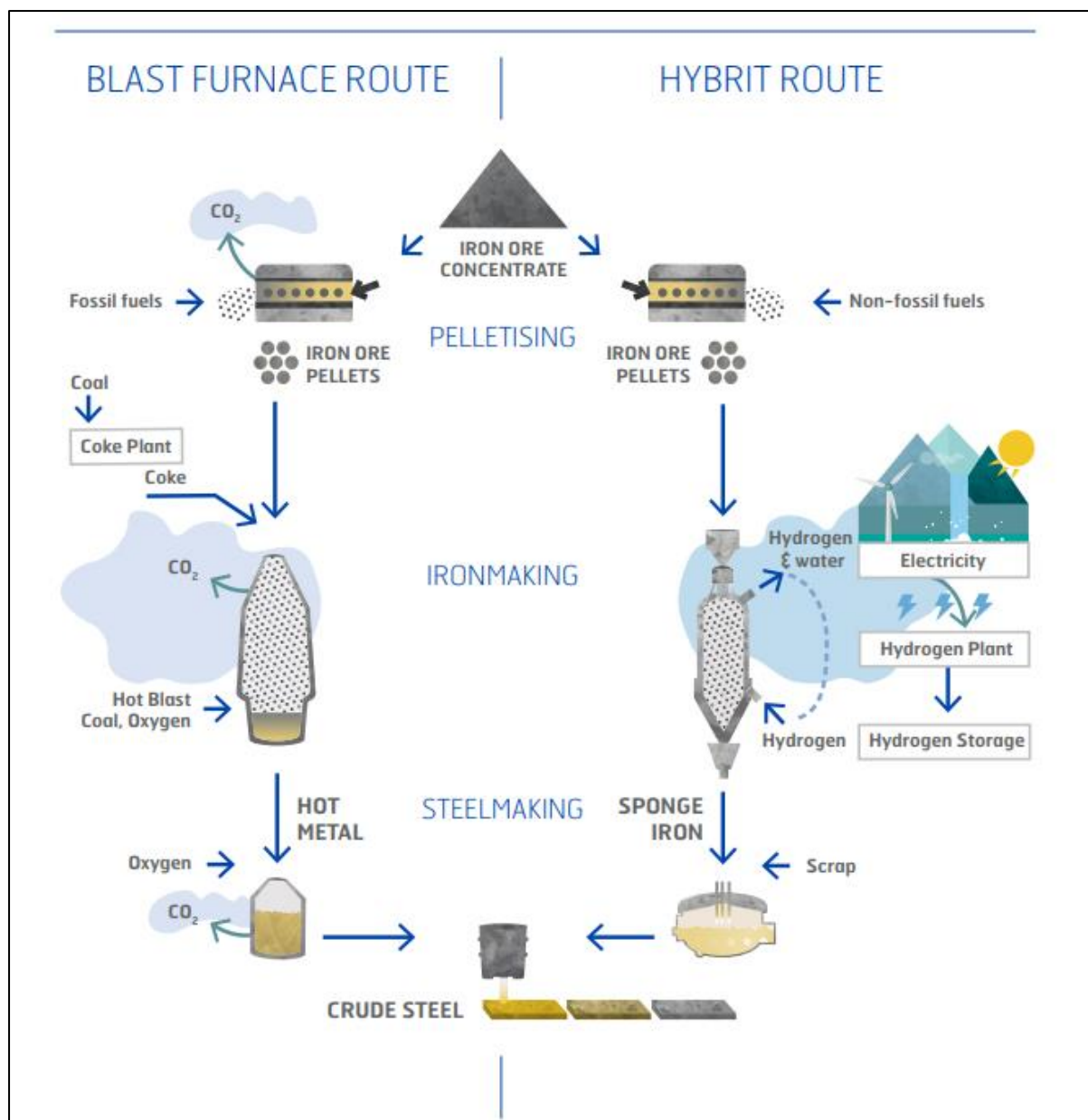

Figure 14:- HYBRIT concept of steel making.

8. Major Sources of Emission

Steel production in an integrated steel plant heavily depends on carbon bearing compounds for process and energy requirement. Coal is the primary source of energy and is used to produce the reducing gases used for iron ore reduction as part of the blast furnace iron making process. Limestone/dolomite are used as fluxes during iron making in the blast furnace, and in the BOS. In an integrated steel plant, coal is used to produce coke in coke oven. Only a very small portion of carbon is retained by steel (up 0.3 wt% of steel). Most of the carbon is emitted to the atmosphere in the form of CO₂ after extracting energy from SMGs. According to World Steel Association, integrated steelmaking based on the blast furnace (BF) and basic oxygen furnace (BOF) uses 1,370 kg of iron ore, 780 kg of metallurgical coal, 270 kg of limestone, and 125 kg of recycled steel to produce 1,000 kg of crude steel. Steel making involves various processes and each process emits CO₂. Therefore, unlike a

fossil fuel-based power plant, an integrated steel plant has various sources of CO₂ emission. The processes that contribute to CO₂ emission in steel production are described here.

8.1 Coke making process

Coke is an essential ingredient in steel making. It allows the formation of the reducing gas (carbon monoxide) as well as providing energy for the reduction of iron ore. Unlike coal which tends to soften at high temperature, coke retains its strength at high temperature and its permeability allows a free flow of gases through the blast furnace. Bituminous or coking coal is used to produce coke in coke ovens where coal is heated to 1000 to 1100 °C in the absence of air to drive out volatile matter. Combustion of fuel to maintain the temperature of the coke ovens and very minor combustion of some of the coke in the coke making process are the causes of CO₂ emissions from the coke making process. The gaseous product of the coke ovens is coke oven gas (COG) which is rich in hydrogen (>50%), methane (>25%) and carbon monoxide (~10%) thus making it a gas of high calorific value (18-20 MJ/Nm³). COG is used in re-heat furnaces, limekilns and ladle heaters, and in conjunction with blast furnace gas, used to heat coke oven batteries and blast furnace stoves, and to generate steam for driving process equipment and generating electricity.

8.2 Sintering Process

Sintering is one of the first processes in primary iron and steel making. The purpose of this process is to produce feed for the blast furnace from iron ore fines. The process involves heating of iron ore fines along with flux (lime) and carbon (eg. coke breeze). In the sintering process at Port Kembla Steelworks, natural gas is used to ignite the coke, raising the temperature above 1300 °C to produce a semi molten mass which is then air cooled to produce porous agglomerates with required characteristics for feeding into the blast furnace. The combustion of those gases, as well as the coke portion of the bed materials, produces CO₂ as shown in chemical equations below.

Combustion of coke breeze

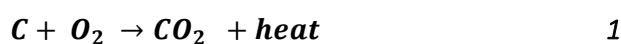

These exothermic reactions raise the temperature of the charge suitable for following reactions to occur

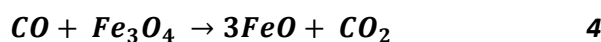
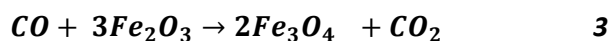

Another source of CO₂ in the sintering process is calcination of carbonate fluxes by the following thermal decomposition reactions

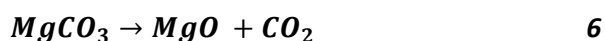
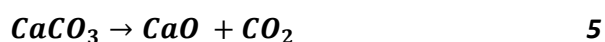

8.3 Reduction of iron oxide in blast furnace

A blast furnace can be considered as a reactor vessel with iron ore, coke, tuyere injectants (pulverised coal at Port Kembla Steelworks), flux and air (hot blast) as feed streams and pig iron, slag and blast furnace gas as product streams. In a blast furnace, the iron ore is reduced to iron by CO produced by partial combustion of coke. The fuel and flux contribute towards CO₂ emission. A major part of the fuel carbon is converted to CO₂, some carbon is retained in the iron (typically 2 to 4 wt % carbon).

In addition to reactions 1, 2, and 3, following reactions take place in the blast furnace to produce CO₂.

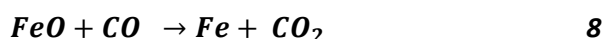

The gaseous products of reactions 1-3 and 7-9, together with the nitrogen contained in the blast air, exit from the top of the furnace and is known as blast furnace gas (BFG). Due to presence of CO (25 - 30 vol %), BFG has heating value in range from 3.2 to 3.5 MJ/Nm³. This low calorific value gas is used as heating medium in the steel plant. The blast furnace itself is not the point source of CO₂ emission. The emissions points are where BFG is burnt to utilize its calorific value. The main consumers of BFG in a steel plant are blast furnace stoves, power plant and coke batteries, which are the point sources of CO₂ emissions.

8.4 Basic oxygen furnace

In a basic oxygen furnace (BOF), pig iron is refined to steel by reducing the carbon content of pig iron (2-4%) to below 1% by injecting high purity oxygen into the molten metal. BOF's gaseous product is rich in carbon monoxide (>60%), but is only produced during the batch operation of the BOF. If no gas recovery is exercised, CO is converted to CO₂ by combustion at the exit of the furnace or flared at the exit of a stack (as is the case at Port Kembla Steelworks). This gas is generally known as converter gas or BOF gas or Linz Donawitz Gas (LDG). LDG is richer in heating value (8-10 MJ/Nm³) than BFG.

8.5 Power plant

In an integrated steel plant, around 45-55% of steel mill gases (BFG + COG, and LDG in many cases) are being used in internal steel making processes and the remainder are used in the power plant as fuel to produce steam to drive process equipment and generate electricity. Combustion of these gases for power generation produces CO₂ making power plant the largest CO₂ emitter in an integrated steel mill. Table 4 provides the composition of fuel gases generated at the Port Kembla Steelworks. Steel mill gases (BFG, COG and LDG) along with natural gas are used to generate power required for steel making process. BFG and LDG have a relatively high carbon content per unit of heating value.

Table 4: Composition of fuel gases used to generate power at the Port Kembla Steelworks (courtesy-BlueScope)

Component	COG		BFG		LDG		Natural Gas	
	Vol %	Wt %	Vol%	Wt %	Vol%	Wt %	Vol%	Wt %
CO	4.5	12.9	22.3	21.0	64	59.6	0.0	0.0
H ₂	59.7	12.2	4.8	0.3	0	0.0	0.0	0.0

Reduction of Greenhouse Gas Emissions in Steel Production

CO ₂	1.6	7.2	20.4	30.2	18.3	26.8	1.5	3.9
N ₂	3.2	9.2	49.5	46.6	9.1	8.5	1.5	2.5
CH ₄	25.4	41.5	0	0.0	0	0.0	94.2	88.7
Hydrocarbons	2.3	10.6	0	0.0	0	0.0	2.8	4.9
Oxygen	0.2	0.7	0	0.0	0	0.0	0.0	0.0
H ₂ S	0.1	0.3	0	0.0	0	0.0	0.0	0.0
Water	3	5.5	3	1.8	8.6	5.1	0.0	0.0
TOTAL	100	100.0	100	100.0	100	100.0	100.0	100.0
Higher heating value (MJ/Nm ³)	19.8		3.4		8.1		39.42	
Total carbon kg/GJ	9.72		66.69		54.53		13.77	

Figure 15 is based on the information provided by BlueScope Steel. It shows carbon flow in an integrated steel works. Carbon enters the steel making process in with raw materials (anthracite, coal, limestone and natural gas). Most of the carbon in raw materials gets converted to CO and CO₂ and becomes part of the steel mill gases; BFG, COG and LDG. The processes where SMGs are used are the point sources of CO₂ emissions. Power plant consumes a large portion of SMGs generated in the steel making process and hence it is the largest point source of CO₂ emission within an integrated steel plant. Figure 15 also shows the % of total CO₂ emitted by each source. Power plant, coke oven plant, sintering plant and blast furnace stoves are the major points of CO₂ emissions.

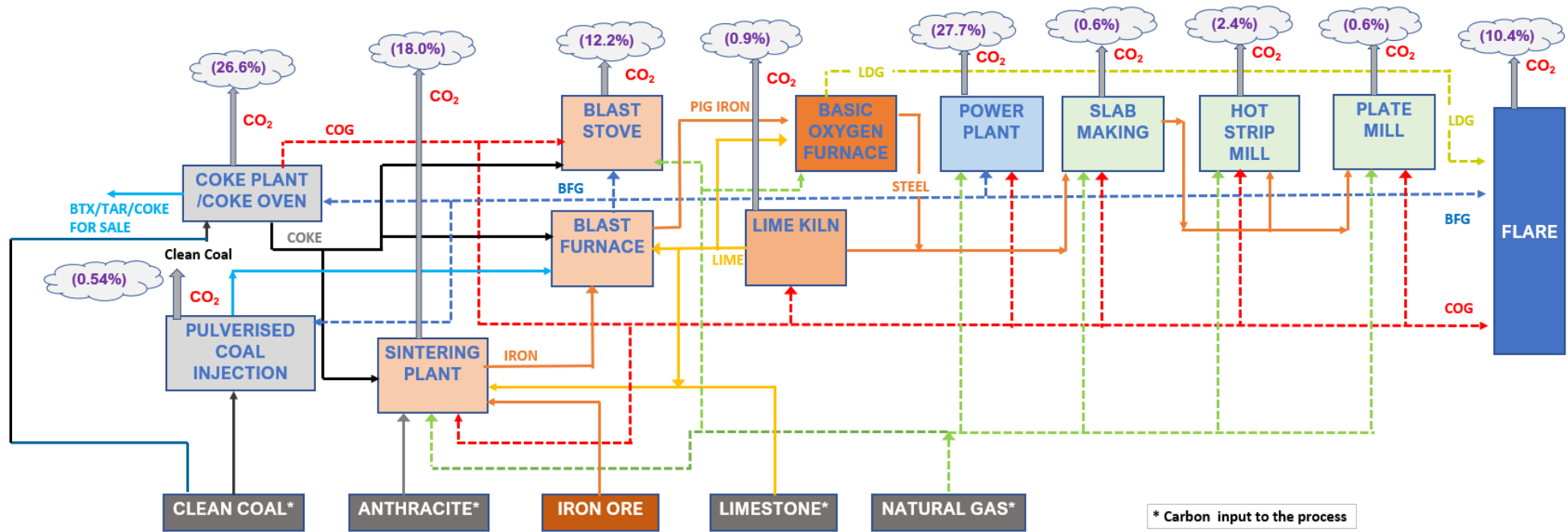

Figure 15: Carbon flow in steel making process and sources of CO₂ emission in an integrated steel plant

8.6 Emissions at BlueScope Steel

BlueScope monitors its CO₂ emissions and reports annually through the Australian Government's National Greenhouse and Energy Reporting Scheme. BlueScope participates in world steel's CO₂ data collection program and that the Port Kembla Steelworks' CO₂ intensity is in the top half of those BF/BOF facilities reporting through the program.

The whole operational site at Port Kembla Steelworks termed as PKSW is divided into following sub operations:

- Coke Making
- Iron Making
- Slab Making
- Hot Strip Mill
- Plate Mill
- Energy Services

Table 5 provides the processes which receive carbon bearing raw material directly. Scope 1 emissions are based on the material consumption and calculated emission factors for that material. Some of the coke, and all the tar and BTX produced, are sold and therefore the CO₂ emissions from these materials are negative. The net Scope 1 emission is the sum of emissions from carbon compounds input to the process and carbon compounds produced by the process. BlueScope reports Scope 2 emissions also.

Table 5:-Consumption of carbon bearing materials in an integrated steel plant (based on the input from BlueScope Steel)

	Energy Services	Coke making	Iron making	Slab making	Hot Strip Mill	Plate mill	PKSW
Anthracite	-	-	X	-	-	-	X
Blended Clean Coal	-	X	-	-	-	-	X
Dolomite	-	-	X	X	-	-	X
Limestone	-	-	X	X	-	-	X
Natural Gas	X	-	X	X	X	X	X
PCI Coal	-	-	X	-	-	-	X
Coke	-	NOTE 1	X	X	-	-	X
BTX	-	NOTE 2	-	-	-	-	-
Tar	-	NOTE 2	-	-	-	-	-

Note 1- Coke is the main product of the coke making process. Coke is mainly used in the iron making process (Blast Furnace) but some is sold

Note 2- BTX and Tar are byproducts of the coke making process and can be sold separately.

Under National Greenhouse and Energy Reporting (Safeguard Mechanism) Rule 2015, BlueScope's reported SCOPE 1 CO₂ emission from its Port Kembla Steelworks was 6.27 million tonnes for the year 2017-18. The estimated SCOPE 1 CO₂ emission intensity was 1.99 tonne CO₂-eq/tonne of steel. During the same period, the SCOPE 2 emissions was 0.582 million tonnes of CO₂-eq and Scope 2 emission intensity was of 0.18 tonne CO₂-eq/tonne of steel. In the year 2017-18, the total emission intensity of BlueScope Port Kembla Steelworks was 2.17 tonne CO₂-eq/tonne of steel. SCOPE 2 emission for steel production depends on the energy mix at the location of the plant and the steel production process.

There can be significant differences in Scope 2 emissions as a result of different electricity generation technology/emissions. For example, 40% of electricity in South Korea is generated by coal. In comparison, New South Wales generates 80% of its electricity from coal and therefore BlueScope's Scope 2 emission is expected to be higher than South Korean steel maker, POSCO.

9. Carbon Capture and Storage

In section 7, global initiatives to develop innovative and breakthrough technologies for CO₂ reduction from steel production were discussed. CCS and CCUS are the prominent technologies to reduce CO₂ emissions. CO₂ capture is part of various initiatives like STEPWISE, ULCOS, POSCO, AISI and COURSE 50.

There are 3 main processes for separating CO₂. These are based on power and energy sectors as these sectors were the main drivers for development of CO₂ capture technologies. However, this technology is applicable to industrial sectors.

1. **Pre-Combustion Capture** - Pre-combustion capture refers to removing CO₂ from fossil fuels before combustion is completed. It involves decarbonation of the primary fuel, commonly coal or biomass. For example, gasification of coal to produce hydrogen. This process has potential application in steel industries if fossil fuel-based hydrogen is used as reducing agent.
2. **Post Combustion Capture** - This process is generally the last process in the process sequence where CO₂ generated from upstream processes is separated from the flue gas mix. This is the most common process for CO₂ capture and has wider industrial applications.
3. **Oxy-fuel combustion** - In this process oxygen is used for combustion of fossil fuel, combustion takes place in nitrogen free atmosphere, water and CO₂ are the main component of flue gas and CO₂ separation is much easier.

There are many technologies (absorption, adsorption, membrane, chemical looping, cryogenics) available for above mentioned processes. However, the technology of choice should have attained a minimum technology readiness level, TRL 8 for a plant to be designated as capture ready plant. Figure 16 shows the development status of various carbon capture technologies on technology readiness level (TRL) scale. Amine based post combustion capture, VPSA/PSA technologies are well developed and commercially available technologies. Post combustion capture process is the most suitable for retrofitting carbon capture to the existing plant as this process does not need any modification in upstream processes.

9.1 Post Combustion Capture

Solvent absorption-based CO₂ capture is the most developed capture technology and is already deployed at large scale carbon capture projects. Emirate Steel's CO₂ capture facility is designed to capture 800,000 tonnes of CO₂ per year. The capture facility is based on traditional MEA Amine Absorption Process and produces 98% pure CO₂ for enhanced oil recovery.

Figure 17 is a simplified process flow diagram for a solvent absorption-based CO₂ capture process. The CO₂ from flue gas is absorbed by a solvent, typically amine-based solvents. The CO₂ rich solvent is then heated and regenerated in a stripping column where absorbed CO₂ is stripped from the rich solvent and sent to a storage/utilization site after compression. The hot solvent is cooled and again used to

absorb CO₂ in absorber column. The steam supplied to reboiler provided the required heat to regenerate the solvent in regenerator/ stripper column. The moisture is removed from the CO₂ stream and then it is compressed to supercritical region for transport and storage.

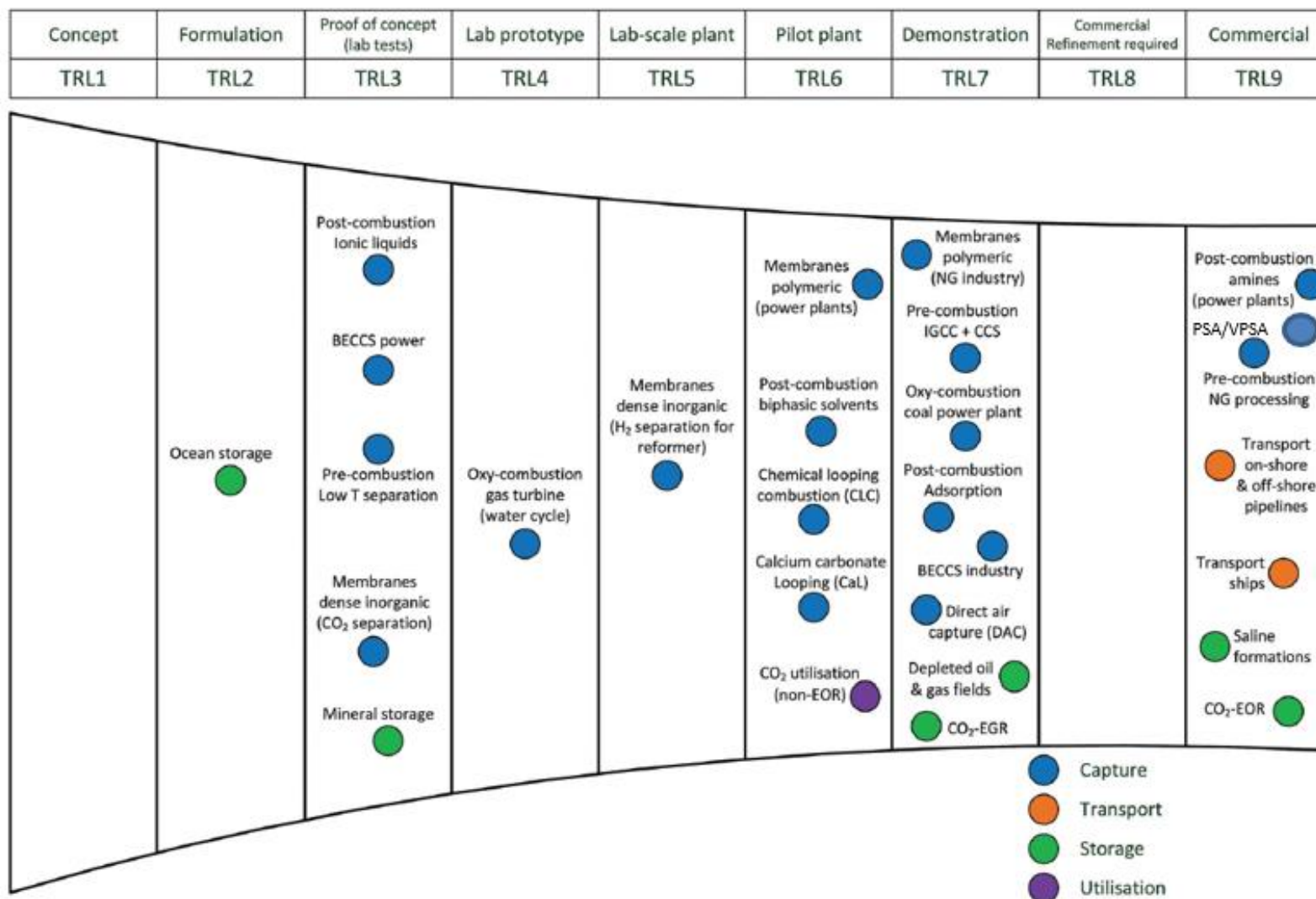

Figure 16: Development status of various CCS technologies.

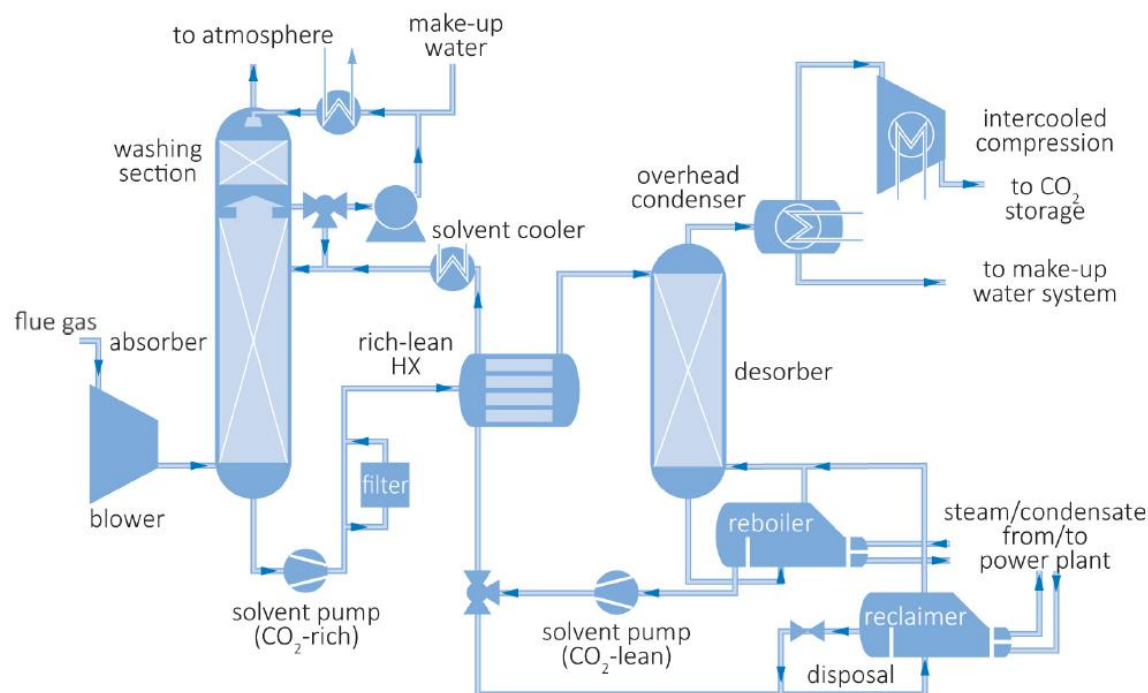

Figure 17- Simplified process diagram for amine-based CO₂ capture

Major research and development activities are in progress to develop better chemical solvents to reduce solvent degradation due to impurities in flue gas, to reduce corrosiveness of solvents and to reduce energy requirements for solvent regeneration. Process and heat integration of the solvent capture process with industrial process can reduce the overall energy requirements of the capture process and synchronise the process with the industrial process.

Figure 15 shows the various CO₂ emissions points for BlueScope Steel. Condition and composition of the gases at these emissions points differ as the sources of CO₂ are different. Not all the gas streams at emission points are suitable for CO₂ capture.

Table 6 shows the typical amount of CO₂ emission and gas stream composition at various emission points. This data is compiled from various sources [40-45]. Table 6 also shows that power plant, hot blast stove, coke off gas and sinter plant waste gas contain more than 85 % of CO₂ emission, whereas lime kiln, hot strip mills and flare account for up to 15% of the CO₂ emission.

Table 6: CO₂ emission at various emission point for BF/BOF route of steel production (data based on various sources)

Stream	CO _{2e} Emissions	Fraction of total Scope 1 emission	CO ₂ Concentration in gas stream	Other contaminants
	kgCO ₂ /tCS	%	%vol	g/tProduct – g/Nm ³
Coke Ovens Heating Stack	60–360	9-16%	11–25	CO (200–4,460 g/tcoke) SOx (80–900 g/tcoke) NOx (336–1,783 g/tcoke) Dust (15.7–298 g/tcoke)
Lime Kiln Stack	57–71.6	~3%	19.3–19.4	CO (200–4,460 g/tL), SOx (80–900 g/tL), NOx (336–1,783 g/tL), Dust (15.7–298 g/tL)
Sinter Plant Waste Gas Stack	200–466	14-16%	5–10	CO (8,783–37,000 g/tS), SOx (219.9–973.3 g/tS), NOx (302.1–1,031.2 g/tS), Dust (40.7–559.4 g/tS)
Hot Blast Stove Stack	240–415	20-25%	25–28.5	CO (1.64–4,336.5 g/tHM), SOx (1.6–231 g/tHM), NOx (6–173 g/tHM), Dust (0.4–18 g/tHM)

Power Plant Stacks	709–982	39-47%	9.9–26.4	CO (0.8–33 mg/Nm ³), SO _x (1.1–305 mg/Nm ³), NO _x (14–190 mg/Nm ³), Dust (0.8–31 mg/Nm ³)
Hot Strip Mill Stack	58-84	3-5%	~10%	
Flares	63-87	3-4%		

Table 7 provides the composition of various flue gas streams at BlueScope. NO_x, SO_x and PM₁₀ emissions limits for coal fired power plants are also included for comparison because CO₂ capture technologies have been traditionally developed for coal /fossil fuel-based power plants. Composition of gas streams, especially the amount of CO₂, O₂, SO_x and NO_x play a significant role in CO₂ capture using absorption technology.

Table 7- Composition of flue gas at various stacks of BlueScope Steel

	Data provided by BlueScope Steel				Coal Fired power plant standards		
	Hot strip Mill	Hot Blast Stove	Power Plant	Coke oven Stack	ASEAN [46]	Japan/Korea/Germany	Australia
CO ₂ (Vol%)	1.9	13.9	14	22			
CO (mg/m ³)	22	38	<3	0.18 %			
O ₂ (Vol%)	17 %	9.2 %	7.6 %	3.5 %			
NO _x (mg/m ³)	152	87	168	300	380-1000	50-200	1500
NO _x (ppmV)	74	42.36	81.8	146	185-487	24.4-97.6	731
SO _x mg/m ³	171	229	300	200	200-850	100-150	100
SO _x (ppmV)	60	80	105	70	70-297	35-52	35
VOC mg/m ³	0.14		0.039	0.43			
PM ₁₀ mg/m ³	6.7 mg/m ³	NR	3.3	NR	80-400	10-100	100

SO_x concentration conversion based on 1 ppm (SO_x) = 2.86 mg/m³
NO_x concentration conversion based on 1 ppm (NO₂ equivalent) = 2.05 mg/m³
ASEAN – China, India, Indonesia, Singapore, Malaysia, Thailand, Vietnam, Cambodia
Australia emission based on License Limit to New South Wales based coal fired power plants NSW Environment Protection Authority Review of Coal Fired Power Stations Air Emissions and Monitoring, 2018 State of NSW and Environment Protection Authority

High concentration of CO₂ in the gas provides ease of CO₂ capture by providing the driving force for absorption of CO₂ by solvent, resulting in lower energy requirement and lower capture plant footprint.

Impurities (like dust, SO_x, NO_x) in flue gas are not desirable. These impurities lead to oxidative and thermal degradation of amine-based solvents.

Oxidative degradation is one of the major solvent degradation processes for amine-based solvents. It mainly occurs in the absorber section where oxygen concentration is highest. According to an Australian study [47], the type of fuel too plays a significant role in oxidative degradation. A brown coal based Victorian power plant has shown a higher degradation rate than a black coal fired power plant in Queensland.

The NO_x content of steel plant flue gas streams is less than that of Australian power plants (Table 7), but closer to the standard emissions of Japan/Korea/Germany. On the other hand, SO_x emissions from steel plant flue gases is more than that for power plants standards for Australia and Korea/Japan/Germany. However, for amine solvent-based CO₂ capture plants, the recommended SO_x and NO_x concentration is less than 10 mg/Nm³ to reduce the solvent degradation. Therefore, the pre-

treatment section of CO₂ capture unit should have NO_x reduction (selective catalytic unit - SCR) and SO_x reduction (flue gas desulphurization unit – FGD). The problem posed by oxygen in the flue gas can be handled by O₂ scavengers and reaction inhibitors, such as hydroquinone, manganese salts, ascorbic acids, Na₂SO₃, and formaldehyde.

In a coal fired plant, the typical concentration of CO₂ is 10-15 vol % and oxygen is 5-8 vol%. Except for flue gas from the hot strip mill, the BlueScope flue gases have higher CO₂ and lower oxygen than for the coal fired power plant. Both the factors imply CO₂ capture operation for BlueScope's flue gases is feasible.

It is observed from the data in Table 6 and Table 7, the sinter plant flue gas has low CO₂ content and the flue gas from hot strip mill has very low CO₂ content and very high oxygen content. Thus, making CO₂ capture difficult from these flue gases. Therefore, the flue gases from the sintering plant and hot strip mill can be excluded from further CO₂ capture assessment.

Table 8:- Steel Plant Off gases consumers and CO₂ emissions at various points as shown in Figure 15 (Based on 2019 emission data provided by BlueScope Steel)

	% age of gas consumed by various processes			CO ₂ Emission
	BFG	COG	NG	% of total Scope 1
PCI	0.8-1.1%	0	0	0.4-0.5%
Coke Making	37-42%	10-12%	0	24-25%
Sinter Plant	0	0	9-11%	16-17%
BF Stoves	16-18%	14-16%	0.2-0.5%	10-12%
Lime Kiln	0	9-10%	0	0.5-1.0%
Power Plant	37-42%	24-26%	25-28%	24-26%
BOF Unit	0	-	0	0
Hot strip mill	0	23-26%	0	2-3%
Plate Mill	0	6-7%	0	0.5-1.0%
Flare	3-4%	6-7%	0	2-4%
LDG unit		0	0	6-8%
Others		0	60-83%	1-2%
Total Fuel	62-65%	12-15%	< 0.5%	0
Emissions due to coal, limestone, Dolomites at various locations				7-9%
Emissions due to BFG				62-65%
Emissions due to COG				12-15%
Emissions due to LDG				6-8%
Notes				
Sinter plant emissions contain emissions from anthracite, limestone also				
PCI emission excludes emissions due to clean coal				
All LDG produced in converter unit is sent to flare				
Others include small consumers of natural gas in the steel plant				

Table 8 shows the consumers of steel plant off gases (BFG, COG and LDG) and associated CO₂ emissions at BlueScope Steel's Port Kembla Steelworks. Coke making, blast furnace stoves, power plant and sintering plant are the major emitters of CO₂. Emissions from coke making, blast furnace stoves and power plant are around 60-65% of the total emissions. As discussed, the flue gases from these sources are potentially suitable for CO₂ capture, after pre-conditioning to remove NO_x and SO_x. Therefore,

CO₂ capture could potentially reduce the emissions of CO₂ by 50% after accounting for process efficiency.

9.1.1 CO₂ Capture from Blast Furnace

From the emission data in Table 8, 62-65% of CO₂ is emitted by consumption of BFG. Based on BFG composition provided in Table 4, 48% of CO₂ emissions from BFG is due to CO₂ content in BFG and 52% is due to combustion of CO in BFG. CO₂ capture from blast furnace gas prior to its distribution to various consumers inside the steel plant is one of the options for reducing CO₂ emission.

POSCO South Korea's GHG reduction program called 'POSCO CO₂ breakthrough framework' aimed to find new solutions for CO₂ emission reduction in the steel industry, and climate change adaptation using steelmaking by-products. CO₂ absorption using ammonia solution is one of the projects undertaken to achieve objective of GHG reduction. POSCO, RIST, POSLAB and POSTECH are the participants in this program. Under the program, POSCO has developed a technique to absorb and separate CO₂ from blast furnace byproduct gas with an ammonia water system. As part of heat integration activities, medium and low temperature waste heat generated at the steelworks is used as the energy needed to recycle the CO₂, making it possible to separate carbon dioxide at low costs.

A pilot plant of 1000 Nm³ BFG/hr (10 tonne-CO₂ per day) shown in Figure 18 was completed in 2011 at POSCO-Pohang Works, South Korea. The capture pilot plant was located in the vicinity of a BFG supply to boilers of a power plant that uses by-product gases from the industry as fuels. A slip stream from main BFG transportation pipeline to power station in an iron-making workplace has been withdrawn. During the demonstration period (2011-2014), the plant has attained a CO₂ capture efficiency of over 90 percent and CO₂ purity of at least 95 percent. According to RIST, the ammonia-based absorption system has several advantages over amine-based system including low regeneration energy and low solvent cost as shown in Table 9. However, loss of ammonia is the main challenge for the CO₂ capture process [48].

After demonstration of capture process, various improvements were implemented to optimize the process. Post modification, the plant was run continuously for 900 hrs. During this period ammonia slip of less than 10 ppm was observed. In 2017, POSCO prepared a large scale design for commercial facility of 300,000 tonne/year CO₂ capture capacity and business model for CO₂ capture and utilization.

Implementation of this technology could reduce the CO₂ emission due to use of BFG by 43 % and overall steel plant emission by 25%. However, use of CO₂ free BFG will bring down CO₂ concentration at the other CO₂ emission points namely power plant stack, hot blast stove and coke oven stacks thus making CO₂ capture from these locations more challenging. CO₂ removal from BFG would reduce the volume of BFG by 20% and will increase heating value per unit volume of BFG by around 20%. The change in volume and heating value of the gas would require an assessment of the implications of the changes to existing BFG consumers.

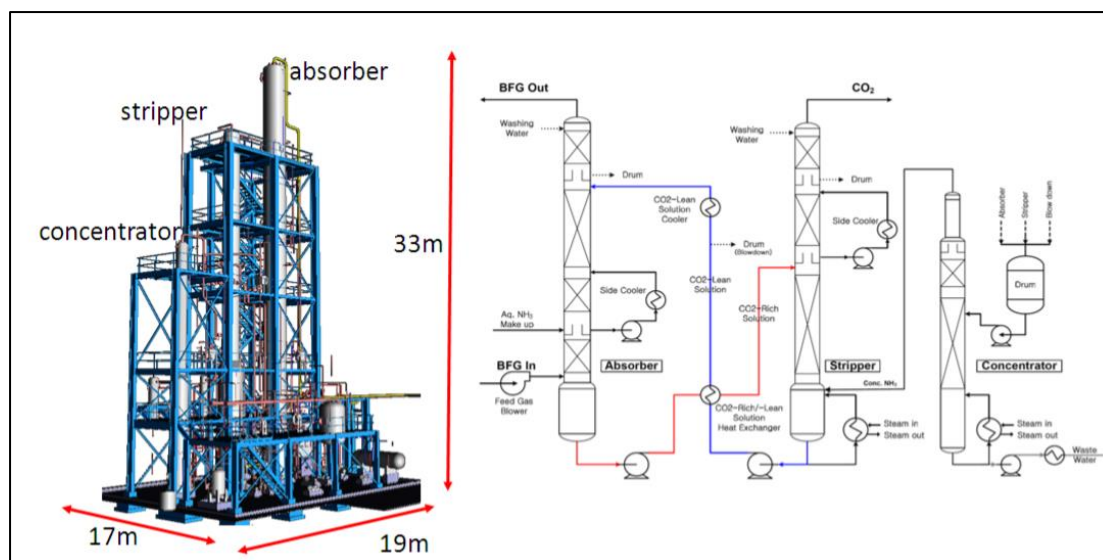

Figure 18:- POSCO's CO₂ capture plant processing 1000 Nm³/h of BFG

Table 9:- Comparison of amine and ammonia-based solvents for CO₂ capture

Absorbent Feature	Amines (Alkanol amine)	Ammonia (NH ₃)
CO ₂ absorption capacity	1.0	2.0
Regeneration energy	1	0.3
Absorbent cost	1	0.17
Regeneration temperature °C	120	80-85
Corrosion	Large	Small
Loss of absorbent	12	2.5
Absorption operation	~50 °C at atmospheric pressure	~40 °C at atmospheric pressure
Challenges	Corrosion, solvent thermal degradation, salt formation, high energy requirement	Solvent loss, high volatility, salt formation
Technology readiness	Successfully commercialized	Successfully demonstrated

Top Gas Recycling of Blast Furnace (TGR-BF), a number of technologies such as chemical adsorption technologies, physical adsorption technologies such as pressure swing adsorption (PSA) and vacuum pressure swing adsorption (VPSA) and cryogenics are available for CO₂ capture. ULCOS (section 7.1) program is based on amine solvent absorption but physical adsorption technologies (PSA and VPSA) are likely to be most effective in terms of technical performance and operating and capital costs. Table 10 lists the comparison of the various technologies applicable to steel industry [49]. PSA and VPSA have lowest energy requirements but the energy requirements for PSA, VPSA do not include CO₂ compression. The CO₂ rich stream from PSA and VPSA has lower CO₂ purity and as such not suitable for storage. Further conditioning of CO₂ rich stream from PSA and VPSA is required which may significantly increase the total energy requirements and costs for CO₂ using PSA/VPSA.

Table 10: Performance and energy requirements for a range of capture technologies available for the steel industry [49]

	Unit	Pressure swing adsorption (PSA)	Vacuum pressure swing adsorption (VPSA)	VPSA + compression and cryogenic flash	Amines + compression	PSA + cryogenic distillation + compression
Recycled gas to blast furnace						
CO yield	%	88.0	90.4	97.3	99.9	100
CO	%vol	71.4	68.2	68.9	67.8	69.5
CO ₂	%vol	2.7	3.0	3.0	2.9	2.7
N ₂	%vol	13.5	15.7	15.6	15.1	15.4
H ₂	%vol	12.4	13.0	12.6	12.1	12.4
H ₂ O	%vol	0	0	0	2.1	0
CO₂ capture (CO₂ rich gas)						
CO	%vol (dry)	12.1	10.7	3.3	0	0
CO ₂	%vol (dry)	79.7	87.2	96.3	100	100
N ₂	%vol (dry)	5.6	1.6	0.3	0	0
H ₂	%vol (dry)	2.5	0.6	0.1	0	0
Suitable for transport and storage		No	No	Yes	Yes	Yes
Energy Consumption						
Electricity	kWh/t CO ₂	100	105	292	170	310
Capture process	kWh/t CO ₂	100	105	160	55	195
CO ₂ compression	kWh/t CO ₂	-	-	132	115	115
LP steam	GJ/t CO ₂	0	0	0	3.2	0
Total	GJ/t CO ₂	0.36	0.38	1.05	3.81	1.12

9.2 Carbon Capture Readiness (CCR)

The term carbon capture readiness or CCR is used in the context of an individual fossil fuel-based power station or CO₂ emitting process plant (like integrated steel plant, cement plant etc.). CCR means it would be technically and economically feasible to retrofit CCS to that power station or process plant in the future, and references to retrofitting CCS to a power station or process plant should be understood to include linking it by way of suitable means of transport to an offshore site of deep geological storage as well as the retrofitting of carbon capture (and CO₂ compression) equipment to the power station/process plant itself.

According to Global CCS Institute (GCCSI), a standardized definition of a CCR plant would increase the ability of countries to efficiently develop and implement policy frameworks to deploy CCS Ready plants by providing a thorough, widely recognized foundation for CCS Ready plant requirements. GCCSI proposed the definition of CCR considers 3 components of CCS separately as capture ready plant, transport ready plant and storage ready plant. Environmental regulations, safety and public awareness and engagement are most important aspects and they are included in all the three components of readiness as shown in Table 11. However, this definition of CCR does not include utilization of captured CO₂.

Table 11:- Proposed International Definition of CCS Ready by GCCSI

Proposed International Definition of CCS Ready		
Capture Ready Plant	Transport Ready Plant	Storage Ready Plant
<p>A CO₂ Capture Ready plant satisfies all or some of the following criteria:</p> <ol style="list-style-type: none"> 1) Sited such that transport and storage of captured volumes are technically feasible; 2) Technically capable of being retrofitted for CO₂ capture using one or more reasonable choices of technology at an acceptable economic cost; 3) Adequate space allowance has been made for the future addition of CO₂ capture-related equipment, retrofit construction, and delivery to a CO₂ pipeline or other transportation system; 4) All required environmental, safety, and other approvals have been identified; 5) Public awareness and engagement activities related to potential future capture facilities have been performed; 6) Sources for equipment, materials, and services for future plant retrofit and capture operations have been identified; and 7) Capture Readiness is maintained or improved over time as documented in reports and records. 	<p>A CO₂ Transport Ready plant satisfies all or some of the following criteria:</p> <ol style="list-style-type: none"> 1) Potential transport methods are technically capable of transporting captured CO₂ from the source(s) to geologic storage ready site(s) at an acceptable economic cost; 2) Transport routes are feasible, rights of way can be obtained, and any conflicting surface and subsurface land uses have been identified and/or resolved; 3) All required environmental, safety, and other approvals for transport have been identified; 4) Public awareness and engagement activities related to potential future transportation have been performed; 5) Sources for equipment, materials, and services for future transport operations have been identified; and 6) Transport Readiness is maintained or improved over time as documented in reports and records. 	<p>A CO₂ Storage Ready plant satisfies all or some of the following criteria:</p> <ol style="list-style-type: none"> 1) One or more storage sites have been identified that are technically capable of, and commercially accessible for, geological storage of full volumes of captured CO₂ at an acceptable economic cost; 2) Adequate capacity, injectivity, and storage integrity have been shown to exist at the storage site(s); 3) Any conflicting surface and subsurface land use at the storage site(s) have been identified and/or resolved; 4) All required environmental, safety, and other approvals have been identified; 5) Public awareness and engagement activities related to potential future storage have been performed; 6) Sources for equipment, materials, and services for future injection and storage operations have been identified; and 7) Storage Readiness is maintained or improved over time as documented in reports and records.

9.2.1 CCR in Iron and Steel Production

The first step in making steel industry facilities capture ready is to select the plant that can be converted to capture ready plants. A common methodology can be applied to select the plants for capture readiness based on following criteria.

Capture Readiness

1. Large scale CO₂ capture and transport is technically feasible as proved by successful operation of Boundary Dam CCS project in Canada (1 MTPA of CO₂), Petra Nova Project in USA (1.6 MTPA) and Emirate Steel capture plant (0.8 MTPA CO₂). In an integrated steel plant there are 3 main sources of CO₂ emissions; 3 coke oven waste heat stacks, 3 power plant boiler stacks and the Blast Furnace stoves stack. The total emissions from these 3 sources (7 stacks) is estimated to be 3.743 MTPA for BlueScope's Port Kembla Steelworks.
2. For BlueScope's Port Kembla Steelworks capture constitutes capturing large quantities of emissions from 3 waste heat stacks at the coke ovens, 3 boiler stacks and BF stoves and piping them to the location selected for the separation plant. These plants are quite a distance apart. Cost of installing this infrastructure would be substantial.
3. Retrofitting capture plant with an existing integrated steel plant as an end of pipe solution is akin to retrofit of capture plant with power plant hence it is technically feasible. There are choices of technologies commercially available as shown in Table 10. Economic feasibility depends on various factors like capital and operating costs, location of storage site, end use of captured CO₂, carbon market and government policies and remaining life of the plant. Steel plants are generally designed for an operating life of 50 years. The life of a steel plant can be extended by proper maintenance and modernization. For a plant to be converted to capture ready, it should have a remaining life of at least 25 years. BlueScope's newest blast furnace (blast furnace #6) was commissioned in 1996 (but shut down in 2011) and the blast furnace #5 was commissioned in 1972. Since then, No.5 Blast Furnace has undergone 3 relines, the latest of which was in done in 2009 which has increased the life of the blast furnace #5. Based on age of blast furnaces at BlueScope, BlueScope still has remaining life of 25 years. In its Sustainability Report 2017/18, BlueScope has shown commitments to an overall 33 per cent reduction in Scope 1 and Scope 2 GHG emissions intensity throughout its global steelmaking sites by 2030 compared to 2005. Further, BlueScope acknowledge that additional work is required to define BlueScope's GHG emissions intensity reduction pathway out to 2050 and beyond to ensure limiting climate change to much less than two degrees above pre-industrial levels. As discussed, to limit climate change to less than 2 degrees, implementation of innovative technologies is required. It can be assumed that in future when business and economic environment is conducive, BlueScope may consider CCS/CCUS technology to reduce its emissions. Addition of CO₂ capture is going to impact the production and economics of the steel plant operation. A thorough economic assessment should be done incorporating policy incentives. To our knowledge, no such study has been done and reported for Australian steel industries. The current project outcomes may lead to such a study.
4. Availability of space for CO₂ capture plant is one of the barriers for capture readiness of the plant. Land requirement depends on the selected capture technology. A recent conceptual study of Post-Combustion Carbon Capture (PCC) retrofit of the Loy Yang A Power Station by CO2CRC has estimated the land area of 105 m X 85 m for a 4.3 MTPA CO₂ capture plant based on solvent absorption technology. BlueScope has sufficient land area available for the capture plant, but it is not near the sources, which again introduces process complexity and cost in any proposed future development.
5. CO₂ capture technology lock up should be avoided. Any CO₂ capture retrofit technology should be selected keeping in mind that CO₂ plant would run for at least the remaining life of steel making process. The capture plant should have enough flexibility to absorb future

changes in CO₂ capture technology. Currently, most of the work on CO₂ capture retrofit for steel plants is based on solvent absorption technology.

6. Source Sink matching study to be done to ascertain the end use of captured CO₂. Preliminary investigations indicate potential storage sites are many 100's of kilometres from the Port Kembla site

Transport and Storage Readiness

Under the scope of the current study, A high-level evaluation of the economic viability of transport (piping or shipping) and storage location options for captured CO₂ from Port Kembla, NSW will be performed. The following four cases have been evaluated

- Transport from Port Kembla – to Darling Basin for storage (via pipeline)
- Transport from Port Kembla – to Gippsland Nearshore for storage (via pipeline)
- Transport from Port Kembla – to Gippsland Nearshore for storage (via ship)
- Transport from Port Kembla - to link into a multi-source grid (North & South NSW power) for a single-sink hub in the Gippsland (via pipeline)

9.3 Carbon Capture & Storage at BlueScope Steel

CCS technologies generally offer the potential to (permanently) capture GHG emissions and are therefore relevant to address the steel plant CO₂ emissions. The Port Kembla Steelworks emits GHG emissions as CO₂, with the integration of a power plant and flaring generally ensuring complete oxidation of its otherwise fuller range of gaseous carbon wastes. So, CCS via CO₂ capture post combustion is a relevant technology for consideration in future BSL GHG emissions reduction pathways.

A CCS solution necessitates that the plant in question is carbon capture ready (so capture ready, transport ready and storage ready) and so necessitates the readiness of appropriate capture (separation), transport and storage technologies. With an expected life of 25 years and BSL's commitment to reduce the Scope 1 and Scope 2 GHG emissions of its steel producing facilities by 2030, the feasibility of a CCS solution for the Port Kembla Steelworks should be assessed. Specific capture, transport and storage solutions need to be identified for this purpose. This scoping exercise is intended to provide preliminary data that may lead to, and assist with, the identification of such specific technical solutions for comprehensive study, if appropriate.

This study is specifically concerned with the CCS for the cases of a CO₂ post combustion capture type scenario (the combined Port Kembla Steelworks emissions) to a single pipeline or shipping port, or on the contribution by the CO₂ source from Port Kembla Steelworks to a collection of CO₂ sources. This reflects the interest to maximise benefit from the energy potential of the BFG, COG and LDG, the prevalence of the power plant and flaring streams, the existing integration and so limited availability of BFG and COG, and the greater maturity (technical readiness) of post combustion capture technologies. Specific focus is on CO₂ capture by absorption via amine type solvent given this technical variant has already been proven commercially at similar scale (energy industry).

The IEAGHG reported on techno-economic evaluation, the breakdown of CO₂ emissions and estimation of the cost of CO₂ avoidance for CO₂ capture from steel production for post-combustion CO₂ capture using conventional MEA) at two different levels of CO₂ capture flow rate (End of Pipe

cases or EOP). The study was based on a new build integrated steel mill of 4 MTPA HRC (hot rolled coil) capacity situated in the coastal region of Western Europe. For this reference case the top 5 sources of CO₂ emission were specified as from the flue gases of the hot stoves, power plant, sinter plant, coke ovens' underfired heaters and lime kilns, constituting ~90% of the total direct CO₂ emissions of the steel mill[50].

IEAGHG has selected MEA solvent capture technology as it was considered an existing technology that could be deployed in an integrated steel mill with moderate risk and would not necessitate any major modifications to the core iron and steel production[50]. The main modifications involved the addition of flue gas processing (i.e. deeper SO_x and NO_x removal, direct contact coolers), CO₂ capture plant (absorber and stripper columns, heat exchangers, reboiler and condensers), CO₂ compressors and dehydration unit, and additional electricity and steam generation capacity.

The application of CCS technologies to utilise and reduce the otherwise CO₂ emissions of the Port Kembla Steelworks was collaboratively investigated by CO2CRC (Capture) and the University of Sydney - School of Chemical and Biomolecular Engineering to help better understand its GHG reduction potential.

The total annual direct CO₂ emission from BlueScope's Port Kembla Steelworks is reported to be 6.27 MTPA for 2017-18. The various sources of CO₂ emissions were discussed in section 8. The CO₂ emissions from power plant, BF hot stoves and coke oven batteries constitutes 60-65% of the total emission. CO₂ capture from coke making, blast furnace stoves and power plant were specifically targeted for this study. These streams have high CO₂ concentrations (>15%) which are preferred to provide for ease of CO₂ capture by providing a strong driving force for CO₂ capture by solvent absorption, resulting in lower energy requirement and lower capture plant footprint. Flue gas from the sintering plant was identified to be a major source of emission from the plant, however has low (<10%) CO₂ content. Flue gas from the hot strip mill was found to have low CO₂ content and high oxygen content. Such low CO₂ content and high O₂ content present difficulties for the capture of their CO₂, so capture from these sources was excluded from this study.

9.3.1 Design Basis

Table 12 lists the flow and composition of flue gas from hot blast stove, power plant and coke oven batteries' stacks. The total CO₂ emissions from these 3 sources is 3.743 MTPA. This is equivalent to 205, 303 Nm³/h of CO₂. The calculated total gas flow to the capture plant is 1,257,156 Nm³/h. The capture plant is designed to capture 90% of the total CO₂ from these three major sources. The capture plant is based on solvent technology and uses standard 30 % MEA solvent. The purity of captured CO₂ is maintained at 98%. To avoid the complexity in the plant configuration, the heat integration is limited to rich lean solvent circuit. It is assumed that the power and steam demand of the capture process to be fulfilled by a stand-alone combined cycle plant based on natural gas. This is done to avoid any modification in the existing power plant and steam distribution system.

Table 12: Flow and composition of three major sources of CO₂ emission at Port Kembla Steelworks

Data provided by BlueScope Steel/Calculated by CO2CRC			
	Hot Blast Stove	Power Plant	Coke oven Stack
CO ₂ emission (MTPA)	0.69	1.556	1.497
CO ₂ emission (Nm ³ /h)	39,832	89,829	86,458
CO ₂ (Vol%)	17.9	14	22
CO (mg/m ³)	38	<3	0.18 %

O ₂ (Vol%)	9.2 %	7.6 %	3.5 %
NO _x (mg/m ³)	87	168	300
NO _x (ppmV)	42.36	81.8	146
SO _x mg/m ³	229	300	200
SO _x (ppmV)	80	105	70
VOC mg/m ³		0.039	0.43
PM10 mg/m ³	NR	3.3	NR
Flue gas flow -Calculated (Nm ³ /h)	222,527	641,638	392,992

9.3.2 Capture Plant Configuration

Figure 19 shows the basic configuration of the capture plant. The plant has two absorber columns and a common solvent regeneration/stripper column. The absorber column, Absorber 1, captures the CO₂ from combined flue gas of power plant and BF hot stoves, while Absorber 2 receives the flue gas from coke oven batteries. The rich solvent from each of the absorbers is combined after the individual heat exchanger network and then regenerated in the stripper column. The stripper column has a steam heated reboiler at the bottom to provide the required process heat for solvent regeneration. The regenerated solvent from the stripper is split into two streams. These stream transfer heat to rich solvent from absorbers before being fed to the absorber columns.

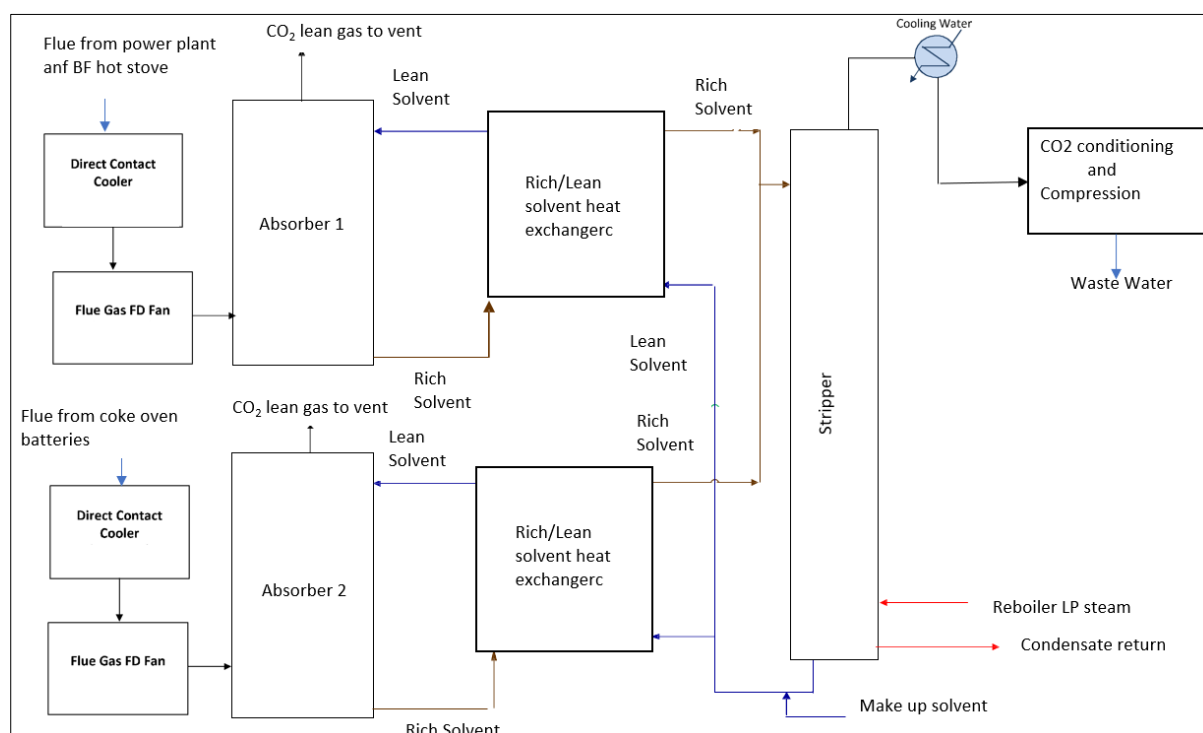

Figure 19: A basic configuration of CO₂ capture plant

The basic specifications of the capture plant are shown in Table 13. The two most important parameters are total electrical power requirement for the capture plant and steam requirement for solvent regeneration. A CO₂ compressor is the major consumer of the electrical power. There are various pumps (solvent pumps, water pump, recirculation pump, absorber intercooler pumps) and fans (gas fan) which consume substantial power. The steam is required by the solvent reboiler to regenerate the solvent in stripper column.

Table 13: Capture plant specifications

		Absorber 1	Absorber 2
Flue gas flow	kNm ³ /h	864.16	392.99
CO ₂ concentration	%	15	22
CO ₂ flow	kNm ³ /h	129.62	86.46
CO ₂ captured	kNm ³ /h	116.66	77.81
CO ₂ captured	MTPA	2.01	1.34
CO ₂ captured	ton/h	229.16	152.85
CO ₂ captured	kg/s	63.65	42.46
Absorber diameter	m	11.6	8.72
Absorber height	m	40	40
Lean solvent flow	kg/h	2,521	1,681
Make up solvent flow	kg/h	40	
Solvent Regeneration			
Stripper diameter	m	9.6	
Stripper height	m	23.1	
Solvent regeneration energy	MJ/kg CO ₂	3.1	
	MW (thermal)	329	
Solvent Reboiler Steam (3.5 bar saturated)	kg/s	153.2	
Solvent temperature at reboiler	°C	< 120	
Electrical power requirement of CO ₂ capture plant			
CO ₂ compressor	MWe	36	
Other auxiliaries of capture plant	MWe	~ 18	
Transportation of flue gases from source to capture plant	MWe	~20	

As shown in Table 13, the capture plant requires 74 MWe of electric power and 153.2 kg/s of LP steam. The captive power plants in a process industry are generally not capable of providing the extra requirements of steam and power. Therefore, an additional source of steam and power needs to be considered. CO₂CRC has done an extensive work on various options to provide steam and power for the capture plant[51]. The most suitable option is to have a gas turbine and HRSG combination. Here gas turbine exhaust is used to generate steam in a heat recovery steam generator (HRSG). The steam generated by the HRSG is used for regenerating the solvent used for CO₂ capture. Unlike, normal combined cycle plant, there is no steam turbine to generate extra power from steam. The objective is to maximize the low-pressure steam generation in the HRSG. If the HRSG is not capable of generating sufficient steam for solvent regeneration, the additional steam is extracted from a suitable extraction point of the existing captive power plant's main steam turbine. The drop in the output of the steam turbine is compensated by the power generated by the gas turbine.

The standard gas turbine models from the various turbine manufacturers (GE Power, Alstom and Mitsubishi) are reviewed. GE Power's gas turbine GE F6.01 can generate 78 MW of electric power in combined cycle thus it can provide the required power of 54 MWe to the capture plant and 20 MWe for flue gas transportation. The gas exhaust temperature is 622 °C and exhaust flow is 454 TPH[52]. However, the gas exhaust can generate only 27 kg/s of LP steam, which is only 18% of the steam requirement of the capture plant. The gas turbine does not have the capacity to compensate for the reduction in power if LP is extracted from the power plant. The gas turbines in the range of 110-125 MW rating were producing 60-70 % of the steam required by the capture plant. The higher rated gas

turbine units which were able to fulfil the steam requirement of the capture plant were producing electrical energy in excess of 175 MWe and hence too large for the present requirements. After an extensive search and analysis, gas turbine model ABB GT 11 N2 (ISO rating 113.6 MW) from Alstom Power is selected for the current purpose. Table 14 shows the performance of the gas turbine with Australian ambient temperature (25 °C). The table shows the gas turbine can generate 110.8 MWe power which is 56.8 MWe more than that required by the capture plant, but the steam generation is only 66.6 kg/s against the requirement of 153.2 kg/s. The remainder of the steam can be extracted from the power plant at the expense of reduction in the power generation. The reduction in the power from the power plant will be compensated by the extra power generation from the gas turbine. Extra steam extraction from the power plant requires modifications in the steam turbine of the power plant. The capability of the power plant to provide extra LP steam and modifications required in the power plant are not in the scope of the existing study.

Table 14: Performance of the gas turbine and HRSG

Parameter	Unit	Value
Gas turbine Output	MWe	110.8
Gas turbine fuel consumption (Natural Gas)	kg/s	6.75
Steam generation in HRSG	kg/s	66.4
Higher heating value of fuel	kJ/kg	53653
Steam pressure	Bar	4.8
Steam temperature	°C	160
Exhaust gas flow	kg/s	360.6
CO ₂ in the exhaust gas	kg/s	17.7

9.3.3 Cost of CO₂ Capture

To calculate the cost of the capture plant, the capture plant is divided into three sections; capture plant (it contains, gas pre-conditioning, direct contact cooler, absorber, stripper, solvent system, auxiliary equipment and CO₂ compressor), power generator (gas turbine, HRSG, feed pump & stack) and modification to the existing power plant for supplying LP steam to the capture plant. The cost is estimated based on the previous work done by CO₂CRC and scaled accordingly.

The National Energy Technology Laboratory (NETL) has prepared Quality Guidelines to provide a standard basis for capital cost scaling [53] and proposed the following Equation to calculate scale costs

$$SC = RC \cdot \left(\frac{SP}{RP} \right)^{Exp}$$

Where

Exp: Exponent = 0.7 for gas turbine steam turbine and heat recovery steam generator (HRSG). For all other plant/ equipment, it is 0.6.

SC: Scale cost

RC: Reference cost

SP: Scale parameter

The cost of the capture plant is estimated from the cost analysis provided by IEAGHG for CO₂ capture from steel plants[50]. The cost of gas turbine is based on Gas Turbine World (GTW) Handbook and converted to Australian dollars. The cost of modification of power plant is estimated at 40% of the

cost of new steam turbine. The cost of 220 MWe steam turbine is 50 to 60 million Australian dollars. The cost of modification of power plant is 25 million Australian dollars. Table 15 shows the breakdown of capital cost for the capture plant. The also includes cost for modification of existing plant and transport of flue gases from source to the capture plant. The cost of transporting flue gas can be substantial as the available land for potential capture plant is far away from the sources. Also, the sources of CO₂ emissions i.e. coke oven batteries (3 stacks), blast furnace hot stove and power plant (3 stacks) are located far apart.

Table 15: Capital Cost for capture plant

Plant	Reference	RP	RC	Ref year	CECPI (ref year)	CECPI (2018)	SP	SC (Million AUD 2018)
Capture plant	[50]	1179 kNm ³ /h	885	2010	550.8	603.1	1257	999
Gas turbine	[54]	115 MWe	31.6	2006	499.5	603.8	115 MWe	38.2
HRSRG	[55]	526 MW th	44.8	2007	525.4	603.8	161.8 MWth	25.4
Flue gas transport								~200
Power Plant								25.0
Total CAPEX cost								1284.6

The operating cost of the capture plant is divided into two part. As per CO₂CRC's costing guidelines, the fixed operating cost is assumed to be 6% of the total Capex. The variable cost consists of cost of gas turbine fuel (natural gas), cost of solvent makeup and cost of process and cooling water. Table 16 provides the details of utilities for the capture plant.

Table 16:- Break up of annual utilities cost

	Quantity	Cost (million AUD/year)
Natural gas	362 158 MWth	91.4
30% MEA Solvent	1.51 TPH	39.75
Cooling Water	415 MWth	10.4
Make up Water	4.2 million m ³ /year	0.498
Boiler Water	240 m ³ /hr	2.51

9.4 Transport and Storage (T&S) of Captured CO₂

The storage and transport of the captured CO₂ is jointly studied by CO₂CRC Limited and The University of Sydney. The objective of the study was to provide technical data and financial costing for the most prospective CO₂ transport and storage options possible to service the Port Kembla Steelworks CO₂ capture plant. The detail of the study is provided in a report form "Scoping economic evaluation of Port Kembla CO₂ transport and storage options". Copy of the full report is presented as Appendix A.

Four different scenarios were considered for transport and storage of the captured CO₂. These scenarios are:

1. pipeline transport to the Darling Basin's Pondie Range Trough storage,

2. pipeline transport to the near shore Gippsland Basin's Barracootta Field storage,
3. ship transport to the Gippsland Basin's Nearshore Barracouta Field storage, and
4. pipeline transport to a pipeline hub and onto a single-sink hub in the a) Darling or (b) Nearshore Gippsland Basin for storage.

The transport and storage assessment is based on CO₂ supply 98 % purity at 3.83 MMT/y, 25 °C, and 0.1 MPa (lower pressure case) and 15 MPa for high pressure case, for a 30 year period.

The study shows that the transport via ship is the costliest option with cost of transport at A\$ 34.75 per tonne of CO₂. Shipping has the lowest capital expenditure but highest operating cost. The two single-source cases (case 1 & 2) have practically the same cost, regardless of the injection location (Darling or Gippsland basin), at approximately A\$31.80 per tonne supplied. Although the option using the Gippsland basin for storage results in larger injection costs due to offshore injection, these are offset by the higher compression requirements for the longer transport distance in the case injecting in the Darling basin. The hub transport options, as expected, yield lower transport costs due to the economies of scale of using larger diameter pipelines for the combined flow rates. The case involving injecting in the Gippsland basin yields a slightly lower unit cost (A\$18.30) than case that uses the Darling basin as storage (A\$21.80), due to the former having a shorter pipeline length before the connection to the hub.

9.5 CO₂ Avoided & Cost of CO₂ Avoided

The CO₂ avoided is the main technical indicator used for the performance of the capture plant. The capture plant captures 3.35 MTPA of CO₂ from multiple stacks at three different sources as shown in Table 13. The total CO₂ emission from the BlueScope Port Kembla Steelworks is 6.27 MTPA. With capture plant in operation, the CO₂ emission is reduced to 2.85 MTPA. However, the gas turbine that provides power to the capture plant emits 17.7 kg/s (0.56 MTPA) of CO₂. The total CO₂ emission with capture plant in operation will be 3.40 MTPA. The total CO₂ avoided is 2.86 MTPA. Hence a net reduction of 45% can be achieved with the capture plant.

CO₂ avoidance cost (\$/tonne of CO₂ avoided) is used as an indicator of economic performance of the CO₂ capture. Using the methodology provided by the IEA [56] and the costs given in Table 15 and Table 16 the cost of CO₂ avoidance for CO₂ capture is 142 A\$/tonne of CO₂ avoided including the cost of the flue gas transport to capture facility. The cost of transport and storage of the captured CO₂ by pipeline is 31.8 A\$/tonne of CO₂. Therefore, the total cost of CO₂ avoidance is 174 A\$/tonne. For first of its kind plant in Australia, GCCSI estimated avoidance cost of US \$ 119/tonne of CO₂ including US \$ 11 /tonne cost of transport [57]. Cost of CO₂ avoidance will have a major impact on the price of steel. With CO₂ capture (including transport & storage), the cost of steel is estimated to be increased by A \$ 161/tonne. During the last 3 years the steel price was in the range of A\$ 670 to A\$ 1000/tonne. Therefore, CCS may increase the steel price by 16 to 24% with emission intensity of 1.25 to 1.35 tonne/tonne of steel. Carbon credit is not considered in this estimate.

9.6 Carbon Capture and Utilization

When it comes to emission reduction, the steel industry presents formidable challenges. Steel making requires high temperature heat for its processes and it is hard to have economically viable alternatives to the fossil fuels that currently provide high temperature heat. Significant emissions from steel production are due to process emissions and reducing these emissions is possible by completely switching over to alternative processes and for steel making there is no such commercially available alternative process. In such a scenario, carbon capture and utilization presents an attractive option

for emission reduction in steel production. Processes which can utilize CO₂ require reliable CO₂ sources in the long term. As demand for crude steel will remain strong despite an increase in recycled steel, steel mills can provide a reliable and long-term source of unavoidable CO₂ to support chemical value chain. According to IEA [58] carbon capture, utilisation and storage (CCUS) technologies are expected to play a critical role in the sustainable transformation of the steel industry. As shown in Figure 20, CCUS is the third most effective measure to reduce CO₂ emission from steel production with a potential to reduce up to 15% CO₂ emission from 2017-2060 [58].

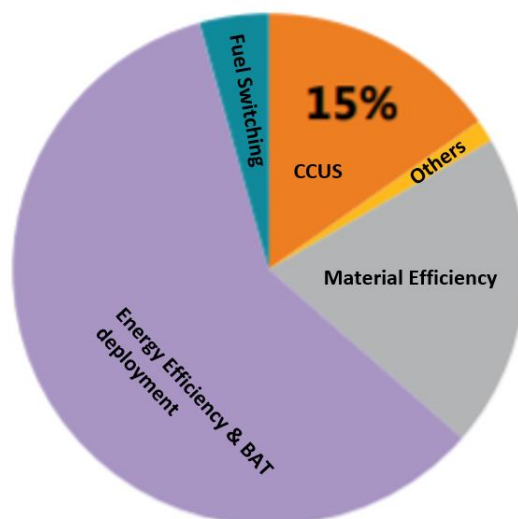

Figure 20:- Global cumulative CO₂ emission reduction in steel production from 2017-2060

The Global CO₂ Initiative was launched in January 2016 with the goal of capturing 10 percent of annual global CO₂ emissions and transforming it into valuable products. In October 2016, it determined that significant progress was made in CO₂ utilization research over the past five years and concluded that “momentum is favorable for four major markets – building materials, chemical intermediates, polymers, and fuels”[59]. Figure 21 shows pathways for utilizing captured CO₂ from an industrial source. The utilization of CO₂ is broadly divided into three categories [60].

- Without CO₂ transformation: captured CO₂ is used as it is without any further processing
- CO₂ Chemical transformation: the CO₂ is used as a feedstock to produce different chemicals through chemical reactions.
- CO₂ biochemical transformation: the captured CO₂ is transformed to valuable product through biochemical reactions.

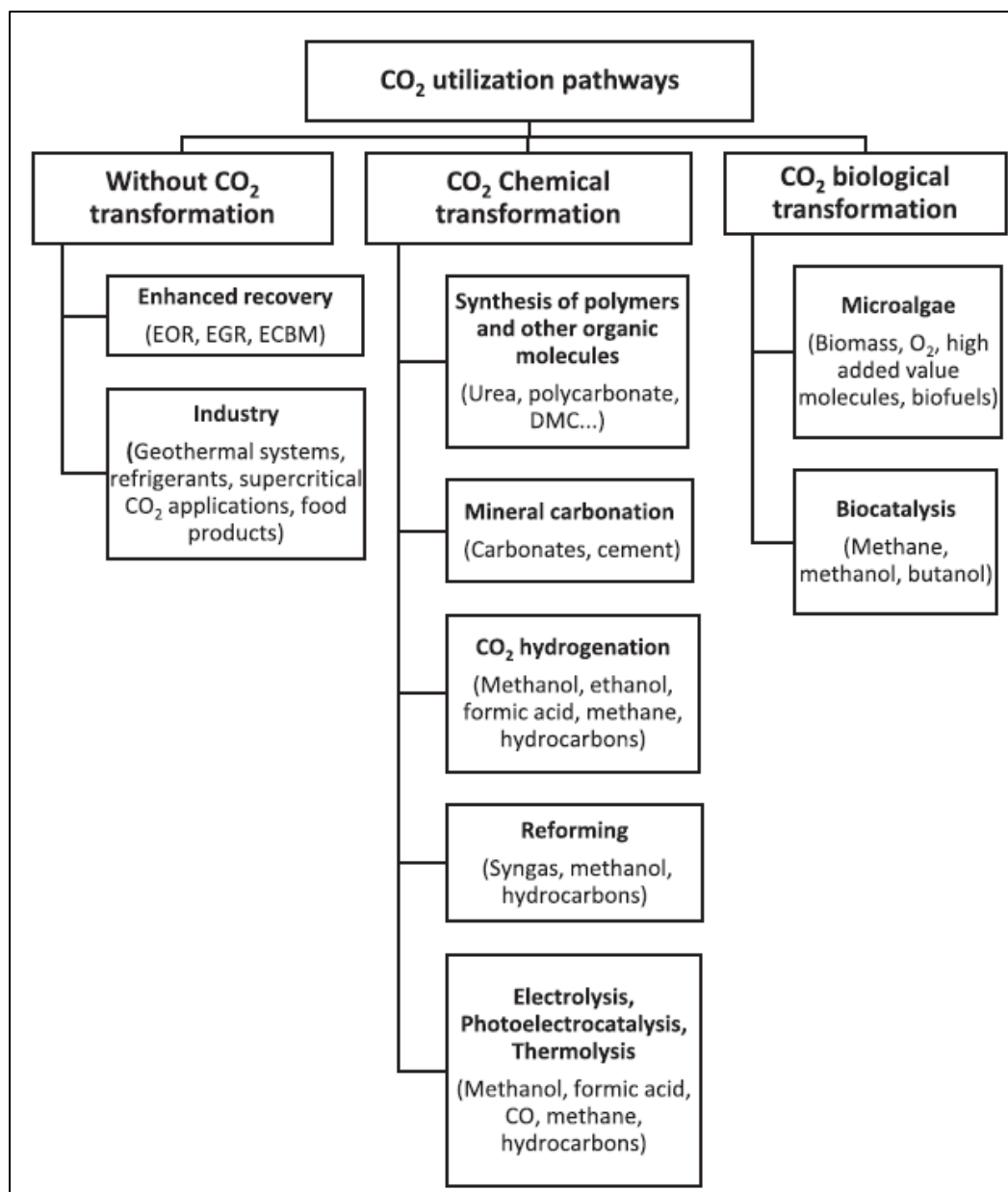

Figure 21: Utilization of captured CO₂

Enhanced oil recovery is the major consumer of CO₂ in non-transformation utilization. By using CO₂ for EOR, the captured CO₂ is stored permanently without being released to atmosphere in its life cycle. Emirates Steel is the first steelmaker in the world to capture its CO₂ emissions and utilizing it for EOR. CO₂ is captured by using traditional MEA absorption process. The CO₂ Compression Facility at Emirates Steel compresses high purity CO₂ captured at the Emirates Steel Industries factory in Mussafah to 238 barg. The captured CO₂ is transported via a 50 km long pipeline to Abu Dhabi National Oil Company (ADNOC) oil reservoirs for enhanced oil recovery.

Australia has about 0.3 per cent of the world oil reserves and as such utilization of CO₂ for EOR is very limited. SANTOS is currently evaluating utilization of CO₂ from its Moomba gas field for EOR. Similarly, Bridgeport Energy is also studying EOR for the Cooper Basin. However, BlueScope's Port Kembla Steelworks is located far away from any potential EOR site thus CO₂ utilization for EOR is not viable for BlueScope Steel.

9.6.1 Utilization Through Chemical Transformation

In this method of CO₂ utilization, the unavoidable CO₂ emission from power plant or industries such as a steel mill serves as the raw material or feedstock for producing other chemicals containing carbon. It is particularly suited for steel mill gases, which contain CO and H₂ as main components along with CO₂. This type of CO₂ use can also reduce the usage of fossil raw materials for production of chemicals in the chemical industry.

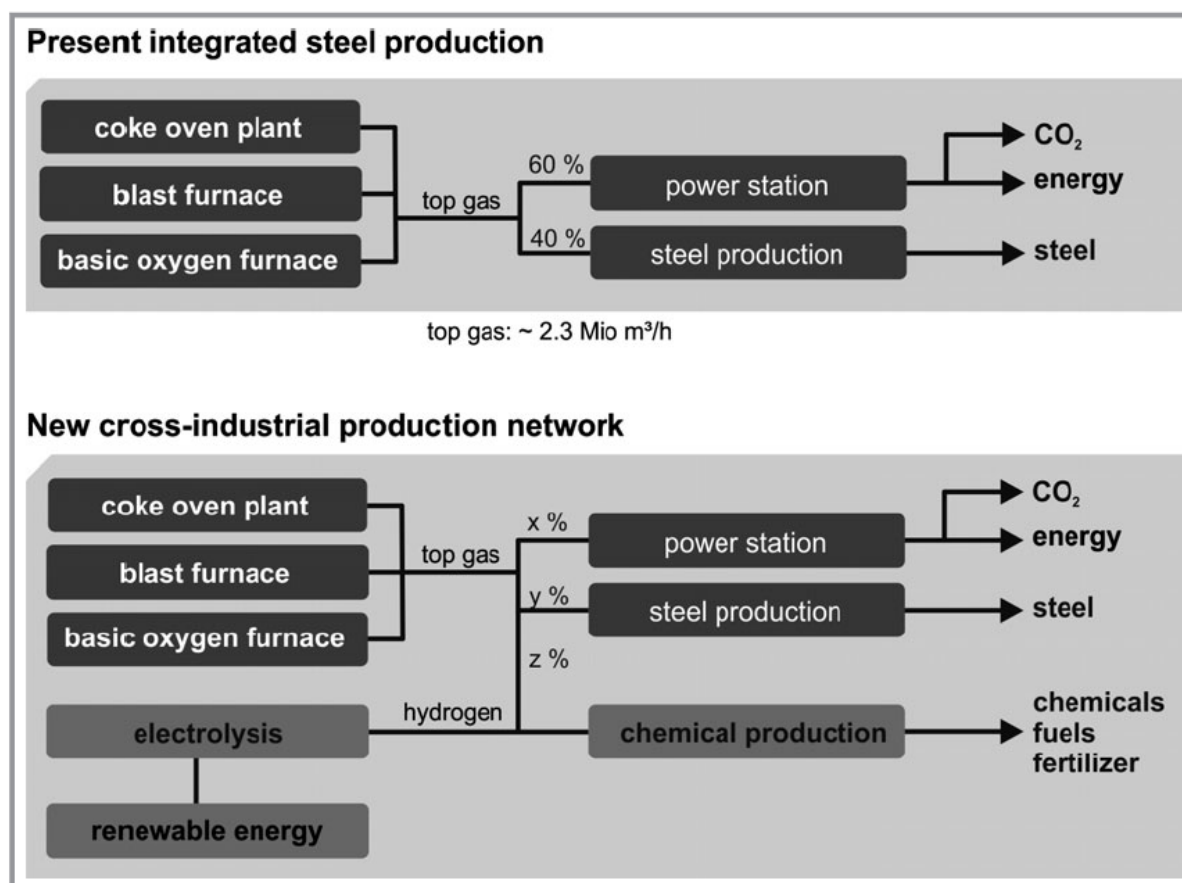

Figure 22:- Utilization of steel mill gases for chemical production (courtesy- ThyssenKrupp Germany)

Figure 22 shows the current and new concepts of utilizing steel mill gases. Currently, the steel mill gases (BFG, COG & LDG) are used for power generation and within the steel mill in various process as shown in Figure 15 and Table 8. Any surplus gas is sent to flare, for example in BlueScope all the LDG produced in the basic oxygen furnace remained unutilized.

In the proposed new concept, all gases are utilized. The concept must fulfill the following conditions [61]:

- It must reduce overall CO₂ emissions through the life cycle.
- It must be safer and ecofriendly compared to the current processes
- It must be economically viable.

Conversion of CO₂ is a challenging task due to thermodynamic stability of CO₂ and the kinetics involved in conversion process. Any CO₂ conversion process must overcome the strong molecular bonds and the low reactivity of CO₂. This makes CO₂ conversion energy intensive and can result in large greenhouse gas footprints. The success of concepts in Figure 22 requires minimization of

nonrenewable energy and the integration of renewable energies that enable the activation of CO₂. Steel plant gases can be used for CO₂ conversion as these gases (Table 4) not only provide the source of CO₂ but also provide source of energy due to presence of CO and H₂.

The Carbon2Chem project started in 2016, with more than 60-million-euro funding from the German Federal Ministry of Education and Research, and aims to explore how smelter gases from steel production can be used to create valuable primary products for fuels, plastics, or fertilizers as shown in Figure 22. A technical centre was built at Thyssenkrupp Steel Europe site in Duisburg Germany to demonstrate the technologies for utilizing steel plant gases for chemical production. Since 2018, the technical centre has successfully demonstrated use of steel plant gases to produce urea and methanol.

Fisher-Tropsch gas-to-liquid (FT-GTL) technologies are well known to provide for the catalysed conversion of syngas to syncrude products including methanol according to Eq. 10. FT-GTL can be used to directly convert CO to methanol, or indirectly convert CO₂ to methanol via the reverse water gas shift reaction according to Eq. 11. Therefore, FT-GTL could be applied to utilize the CO_x contents of steel mill gases to produce valuable liquid fuel products. Process variants and product speciation are generally distinguished by catalyst types and process conditions, the syncrude products are typically upgraded to prepare the various product streams via subsequent separation processes. Eq's. 12 & 13 summarily show the path for methanol production from CO and CO₂ respectively.

The direct utilization of CO₂ by catalysed hydrogenation to methanol reactor as per Eq. 13 is also reported, for which thermal, photo- and electro- assisted processes are described, and is considered a good path forward when cheap H₂ is available [62]. The production of 4000 tonnes per year of methanol by the catalysed combination of hydrogen (as generated from surplus energy via the hydrolysis of water) and captured CO₂ under pressure has been well established with efficiency of >60 % for Svartsengi Iceland by Carbon Recycling International [63]. It is one of several electrolyser mediated power-to-fuel technologies targeted for their potential to provide an alternate attractive means for energy storage for which surplus energy rather than fuel is used to convert captured CO₂ into fuel [63]. A Cu/ZnO/Al₂O₃ catalyst has been developed to be highly active and cost effective for methanol synthesis from carbon oxides and H₂. These bimetallic catalysts are recognized to have emerged “as an important class of catalysts due to their unique properties and enhanced catalytic performances compared to their monometallic counterparts”[64].

The production of a methanol product is generally attractive given the existing market size for this commodity product (110 million metric tons pa in 2018 [65]), that growth is forecast for this market industry [66], and its promise as a useful C1 hydrocarbon carbon building block [67]. It is also noted that methanol synthesis overall ranks as the second largest source of hydrogen consumption after ammonia production[67]. “The global methanol demand by end-use are the production of formaldehyde (27 %), olefins (18 %), acetic acid (9 %), and methyl *tert*-butyl ether/*tert*-amyl methyl ether (MTBE/TAME) (8 %)”, and 16 % of methanol consumed is used as solvent or fuel additive [68].

Currently, methanol is typically produced via the conversion of syngas generated by natural gas steam reforming, however it can be made from syngas derived from many other feedstocks (e.g. coal, biomass, municipal solid waste, biogas, waste CO₂, and even renewable energy)[69]. MeOH production via natural gas steam reforming for transport fuel is reported to incur GHG emissions of ~38 gCO₂e/MJ MeOH on a LHV basis [70]. Transport fuel mixtures comprising methanol (85 %) and reformulated gasoline (15 %) are reported to incur total GHG emissions (i.e. well to product + vehicle operation) ranging from 43-74 gCO₂e/MJ, and so incur substantially less emissions than for reformulated E10 Gasoline (total = 91.3 gCO₂e/MJ, well to product = 25.0 gCO₂e/MJ[70]). Accordingly, methanol based fuels can incur less total GHG emissions than compressed natural gas, liquefied

petroleum gas and ethanol which incur 76.2, 77.2 and 70.4 gCO₂e/MJ respectively, and so are of particular interest [70].

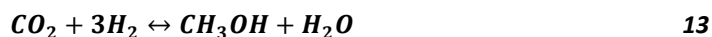
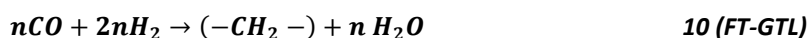

Urea production by the Bosch-Meiser process via ammonium carbamate intermediates per Eq's 14 & 15 [62] is also well known for CO₂ utilization. Urea is well recognized as a common agricultural fertilizer whereby it releases ammonia and CO₂ into soil, but also has various other industrial applications[62]. However urea production is not generally recognized as a carbon reduction measure because although 0.7 tonne of CO₂ is consumed per tonne of urea produced, 2.27 tonnes of CO₂ are emitted per tonne of CO₂ utilised [62].

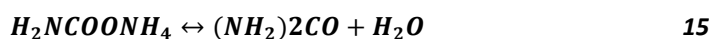
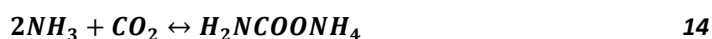

9.6.1.1 Urea and Methanol from steel plant gases

The main components relevant for chemical processes to produce urea or methanol are hydrogen, carbon monoxide, carbon dioxide, methane, and nitrogen. Looking at the composition of steel plant gases from Thyssenkrupp and BlueScope in Table 17, COG can act as a high-grade hydrogen source and LDG as a CO/CO₂ synthesis gas source. Blast furnace gas (BFG) is a good carbon source, but high nitrogen content can be a limitation. Methanol and the ammonia/urea synthesis require 2 to 2.5 moles of hydrogen per mole of carbon, the steel plant gases do not have sufficient hydrogen for ammonia/urea/methanol synthesis. Therefore, a reliable additional source of hydrogen is necessary. Green hydrogen can be obtained from a water electrolysis unit operated by electric power from green and sustainable resources (solar/water/wind). Availability of hydrogen has a significant impact on the carbon footprint of the concept.

Figure 23 is a schematic showing current and future potential utilization of steel plant gases. Currently, the steel plant gases are used in power generation and internally in steel making processes. This is considered as a Base Case. In Case A, a portion of these gases will be utilized for processes to produce chemicals (ammonia, methanol & urea). In case B, the steel plant gases will not be used for internal processes and gases will be utilized for power generation and chemical processes only. Natural gas will replace steel plant gases for providing the required energy in the internal steel making processes. The major processing steps involved are:

- Gas cleaning- Cleaning the gases to remove dust, sulphur and chloride impurities
- Water gas shift (WGS) reaction ($CO + H_2O \rightarrow CO_2 + H_2$) for BFG and LDG to obtain hydrogen, the steam requirement for WGS reaction can be sourced from the power plant.
- Carbon capture to have CO₂ rich and H₂ & N₂ rich stream
- Separate hydrogen from COG using pressure swing adsorption (PSA) process.

- Produce ammonia (NH₃) by using H₂ stream obtained from COG and H₂ & N₂ streams from LDG/BFG.
- Ammonia and CO₂ are the basic chemicals to produce urea.

Table 17: Availability of steel plant gases with composition at Thyssenkrupp Steel Duisburg plant (data - courtesy Thyssenkrupp), numbers in bracket are based on data provided by BlueScope Steel for Port Kembla Steelworks

	BFG		LDG		COG		Total Mixed	
Flow (kNm ³ /hr)	1780	(436.5)	98	(150)	152	(90.1)	2030	(676.6)
CO [vol %]	25	(23.0)	64	(70.0)	7	(4.6)	26	(31.0)
CO ₂ [vol %]	23	(21.0)	17	(20.0)	2	(1.7)	21	(18.2)
N ₂ [vol %]	48	(51.0)	14	(10.0)	6	(3.3)	42	(35.6)
H ₂ [vol %]	4	(4.95)	5	(0.00)	63	(61.6)	9	(11.4)
CH ₄ [vol %]	0	(0.00)	0	(0.00)	22	(26.2)	2	(3.5)
HCs [vol%]	0	(0.00)	0	(0.00)	0	(2.4)	0	(0.3)
Gases to power plant [%]	60	(38.80)	0	(0.00)	43	(25.02)	55	(28.4)
Gases for internal processes [%]	40	(61.20)	100	(0.00)	57	(74.98)	45	(49.5)

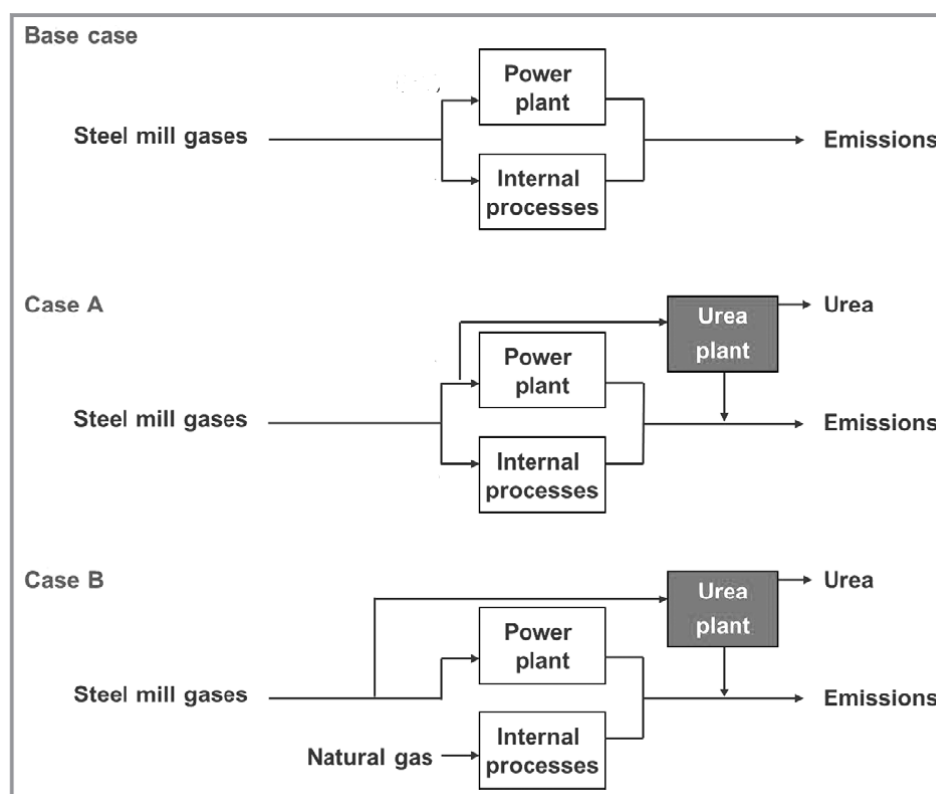

Figure 23:-Utilization of gases in a steel plant, Base case is the current practice (courtesy- Thyssenkrupp)

CO₂ can be utilized to produce methanol (CH₃OH) which is an important platform chemical in production chain of many industrial chemicals. Due to its high-octane number and low emissions, methanol is widely investigated as a clean fuel for internal combustion engines. In addition, methanol can be used a liquid hydrogen carrier for energy storage in a hydrogen economy. Currently, methanol

is produced from syn gas produced by natural gas reforming or coal gasification. Syn gas is a mixture of CO, CO₂ and H₂; these components are also present in varying composition in steel plant gases. Therefore, synthesis of methanol from steel plant gases can contribute towards reducing GHG.

Methanol can be produced from syn gas according to the chemical reactions given in equations 12 & 13. The rate kinetics, yield and selectivity depend on catalyst.

Figure 24 shows the ways to produce methanol from LDG & COG through reaction 10 & 11. Whereas if BFG is used then reaction 11 dominates. Like ammonia production, the first step is gas clean up and purification to avoid catalyst poisoning and deactivation. Production of methanol requires a source of hydrogen, COG can be a source of hydrogen, but it does not have enough hydrogen to utilize the full amount of available LDG. Therefore, economic green hydrogen must be available to realize full GHG reduction potential of steel plant gas utilization.

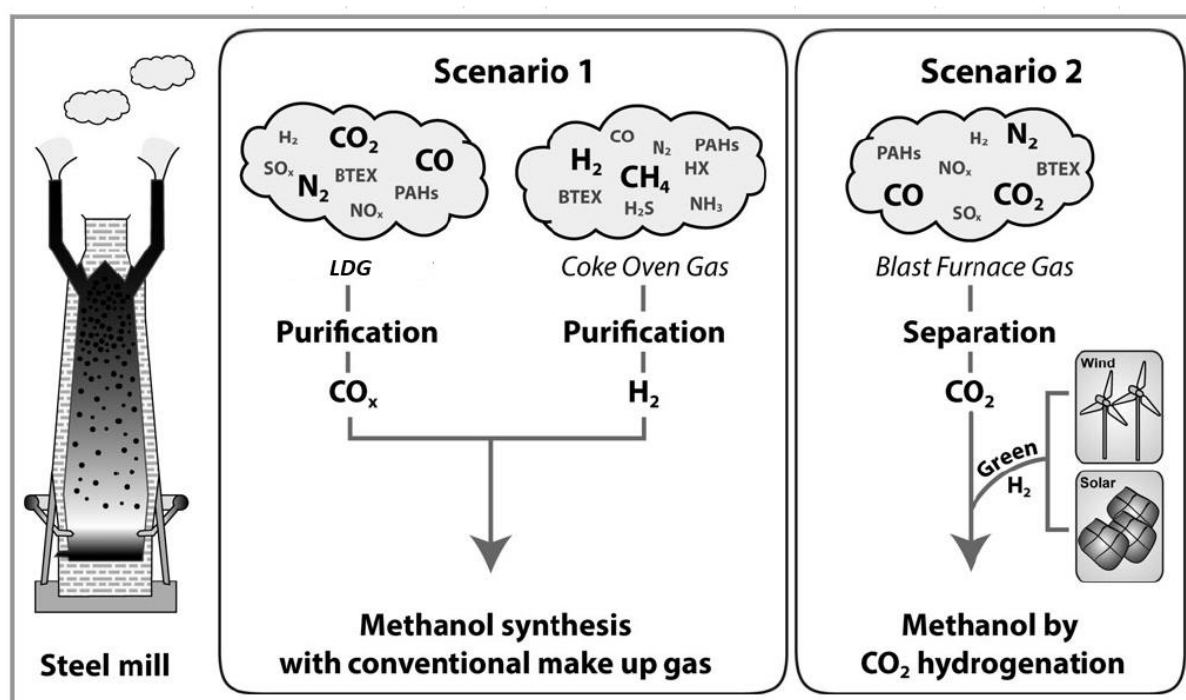

Figure 24- Possible utilization routes of steel plant gases for methanol production [71]

According to a recent study by Thyssenkrupp, a 45% reduction in GHG emissions can be achieved in Duisburg steel work in Germany by utilizing steel plant gases for urea production if green hydrogen (emission free hydrogen) is available. In case of methanol production, the comparative CO₂ reduction is shown in Figure 25. Compared to a business as usual case for steel and methanol (by natural gas) production, a reduction of around 70% CO₂ emission can be achieved if steel plant gases are utilized for methanol production.

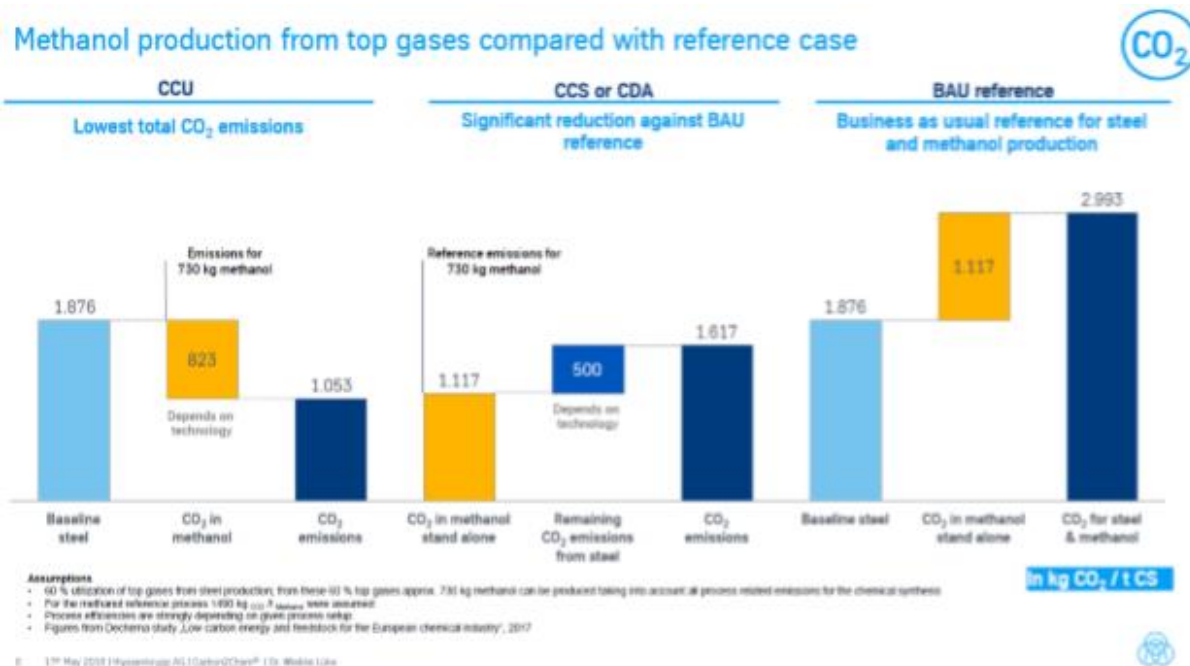

Figure 25: CO₂ emissions reduction potential for SMG utilisation by methanol production via TK-Process [Source: Thyssenkrupp]

9.6.2 Utilization Through Bio-chemical Transformation

Currently, the steel plant gases (blast furnace gas, coke oven gas and converter gas) are fed to power generation as fuel. Combustion process of the fuel generates CO₂ therefore making the power generation unit a large CO₂ source in the steel industry. Production of alternative liquid transportation fuels (ethanol and biodiesel, among others) from renewable feedstocks is a popular emissions reduction strategy. Corn based ethanol has been a commercial success. Large scale biofuel production has its limitation due to competition for land and water resources and its impact on food prices. Biofuel based on agricultural waste/residue, non-food items and other wastes are termed as “second generation biofuel”.

There are a few biochemical conversion processes, one of them to produce microalgae in open ponds or photobioreactors. A photobioreactor utilise a light source and CO₂ to cultivate photo tropic microorganisms via photosynthesis. The harvested algae can then be used to produce bio-fuels in place of a non-biological carbon source. Most research is directed to the use of microalgae which are grown in photobioreactors. On the other hand, a bacteria fermentation process offers the opportunity to sustainably produce fuels and chemicals without impacting the availability of food resources or farm land, whilst at the same time provide significant reduction of CO₂ emission.

Several companies including Coskata, IneosBio, and LanzaTech (LT) have pursued the commercialisation of microbial driven syngas fermentation to produce ethanol. This is achieved via the Wood Ljungdahl pathway characteristic of acetogen type microbes [72] for which the organisms can use H₂ as an electron donor and CO₂ as an electron acceptor, as a building block for biosynthesis[73]. The process is understood to proceed via conversion by anaerobic acetogenic bacteria into ethanol (fermentation bath, recovery by distillation).

LanzaTech has developed a strain of *Clostridium* bacteria that can convert the carbon and energy in CO to fuels or chemicals at high selectivity, resulting in higher overall fuel and thermal efficiency than

conventional chemical synthesis routes[72]. These microbes also have the ability to use a flexible H₂/CO ratio feed gas and to tolerate numerous impurities, including the presence of significant amounts of sulfur compounds (e.g. H₂S or COS). Therefore, extensive clean-up is not required for steel waste gas feed[72]. The LanzaTech (LT) Process is a low-temperature and low-pressure process compared with the conventional chemical synthesis routes. To overcome the issue of the low solubility of CO and H₂ in water, LanzaTech has developed a unique bioreactor design with novel gas introduction methods to maximize the gas to liquid mass transfer and enhance the gas dissolution[72].

The chemistry of the LT-Process is understood to involve a highly efficient biological water-gas shift reaction catalysed by carbon monoxide dehydrogenase within the microbe whereby, through a series of intermediates, CO and CO₂ are ultimately fixed as acetyl-CoA by a CODH/ACS complex. Equations 16 & 17 show the general reactions relevant to the resulting conversion of CO and H₂ to ethanol[72]. Accordingly, the conversion of CO can be substantial without H₂, but can be essentially complete with the addition of H₂ (H₂:CO ratio of 2:1), albeit the overall consumption of CO would be reduced for too much H₂ addition. If there is a lack of H₂, the microbes can perform an internal WGS reaction to convert CO to H₂, yet this reduces the amount of CO that can be converted to products[72]. So, the merit of waste gas containing H₂ or the addition of renewable H₂ is understood.

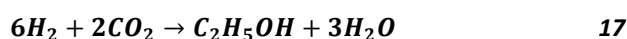
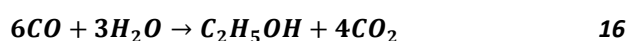

Figure 26 shows a generalized scheme and operational boundaries of the LT process and so the three key steps of the process: Gas Compression, Fermentation, Product Recovery. Following gas clean-up, there may be additional gas compression and deoxygenation required depending on the operating conditions of the gasifier and properties of the syngas [72]. The compressed gas is used as the primary input to the biological reactor for fermentation[74]. In the biological reactor, the proprietary microorganisms are suspended in a liquid nutrient solution to facilitate the fermentation, to utilise the CO as both a carbon and energy source[74]. In the product recovery step, a distillation-based system separates the fermentation broth into the final Product and Co-Product[74].

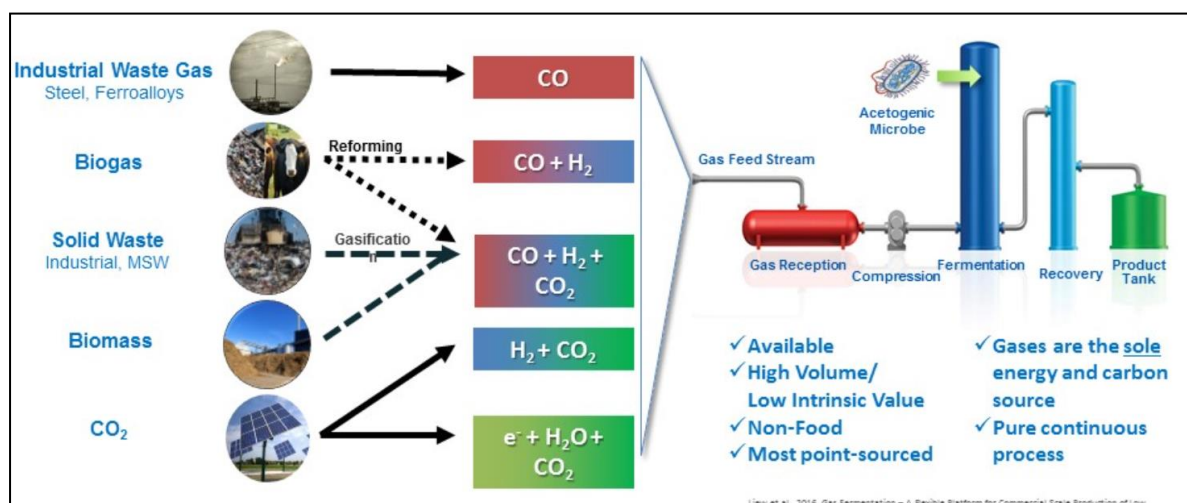

Figure 26: Generalized scheme for the LT process as applied industrial waste gas streams or biomass feedstock

The steel gas plant is rich in CO, H₂ and CO₂, which can be utilised to produce valuable product using proprietary microbes developed by LanzaTech. The LT process can potentially convert carbon monoxide and hydrogen in SMGs into valuable fuel and chemical products, including ethanol, 2,3-butanediol, acetic acid, isopropanol, acetone, butanol and succinic acid. LanzaTech in collaboration the US Department of Energy's Pacific Northwest National Laboratory (PNNL) developed the proof of concept and lab scale demonstration of the innovative technology to convert the product from LanzaTech's gas fermentation process (ethanol) to drop-in jet fuel. This technology was demonstrated successfully at China LanzaTech Shougang facility producing 4,000 USG of jet fuel from ethanol. Based on the detailed lifecycle analysis (LCA) study, 65% reduction of greenhouse gas emissions is achievable using LanzaTech-PNNL technology.

LanzaTech technology is commercially available. Table 18 lists the various projects based on LanzaTech process.

Table 18:- Pilot, Demonstration and Commercial Plants that demonstrated LanzaTech technology

Project	Location	Input feed	Product	Capacity	Scale	Status	Start year
NZ Waste Gas to Fuel Industrial Pilot Plant	Glenbrook, NZ at Blue Scope Steel Mill	Steel flue gas	Ethanol	15,000 gpa	Pilot	Shutdown	2008
(1st) China Waste Gas to Fuel Demonstration Plant	Shanghai, China at BaoSteel Steel Mill	Steel flue gas	Ethanol	100,000 gpa	Demonstration	Shutdown	2012
(2 nd) China Waste Gas to Fuel Demonstration Plant	Beijing, China at Shougang Steel Mill	Steel flue gas	Ethanol	100,000 gpa	Demonstration	operational	2013
Taiwan Waste Gas to Fuel Demonstration Plant	White Biotech (WBT) in Kaohsiung	Steel flue gas	Ethanol	100 kg/day	Demonstration	shut down	2014
China Waste Gas to Fuel Commercial Plant	Jingtang Steel Mill in Caofeidian, Hebei Province	Steel flue gas	Ethanol	16,000,000 gpa	Commercial	Operational	2018
STEELANOL Project	Ghent, Belgium	Steel plant gases	Ethanol	25,000 ton/year	Demonstration	Work started in Jan 2019	

9.6.2.1 Ethanol from LanzaTech Process- LCA

A LCA of ethanol production from a Woody biomass derived syngas via a biochemical LanzaTech process route was compared with that for its production from the same biomass derived syngas via a conventional thermochemical path[72]. The GHG emissions associated with the ethanol production via these processes were determined to be 24.8 lb CO₂/gal (2.97 kg CO₂/l) and 30.2 lb CO₂/gal (3.62 kg

CO₂/l) respectively[72]. These results highlighted the potential advantages of gas fermentation over the thermochemical conversion of syngas to ethanol, and more generally to fuel or chemicals[72]. E4Tech has done an LCA study of LanzaTech process to produce ethanol from basic oxygen furnace gas (LDG) using microbes. The study was according to EU RED (Renewable Energy Directive) methodology. The life cycle GHG emission of ethanol from LanzaTech process is 19.6 g CO₂e/MJ as compared to 83.8 g CO₂ e/MJ for ethanol produced from fossil fuel. LanzaTech ethanol achieves a 76.6% reduction in greenhouse gas emissions over baseline fossil fuel [75, 76].

As a business case, Ethanol production by LanzaTech process provides 2 times more returns than electricity. LanzaTech Process emits ~40% less NO_x and ~80% fewer particulates than electricity generation per MJ energy recovered and emits 33% less CO₂ than electricity generation per MJ energy recovered [77].

LanzaTech’s “CCU-Now: Fuels & Chemicals From Waste” presentation [78] reports LCA for LT-EtOH as performed in cooperation with Michigan Tech University, Roundtable on Sustainable Biomaterials (RSB), E4Tech, Ecofys and Tsinghua University to be 25-45 gCO₂ e/MJ[79]. It specifies that LT-EtOH provides 50-70% GHG reductions over conventional gasoline (90 gCO₂ e/MJ)[79]. LT-EtOH process provides the environmental, economic and social benefits: new revenue stream from waste materials, energy security from sustainable regional resources, affordable options to meet growing demand and economic development that creates “green jobs”[78].

In case of steel plants, LanzaTech gas-to-liquid (GTL) processing found to be favorable in terms of life-cycle in China’s steel manufacturing and can reduce greenhouse gas emissions by approximately 50 % compared with the conventional petroleum gasoline [80]. Handler et al (2016) conducted an at arm’s length LCA of a LanzaTech process using LDG based on a cradle-to-grave approach [74]. In this study, the total GHG emissions for LT-EtOH production from LDG were calculated to be 31.4 gCO₂eq/MJ ethanol [74]. These total GHG emissions are reported to be less (67% emissions reduction) relative to life cycle GHG emissions for petroleum gasoline, and to meet the same emissions reduction targets given to cellulosic biofuels according to EPA guidelines[74]. For this Handler et al (2016) study, a detailed inventory of processing inputs was developed from LanzaTech’s commercial plant design in collaboration with LanzaTech process engineers, the key inputs are summarily listed in Table 19. The analysis considers the production of all required inputs including chemicals and energy, all emissions of gases from the bioreactor and anaerobic digestion of settled solids, the transport of the ethanol product prior to its use (transported 100 km by truck[74]) and final combustion of the ethanol, and assumes that any methane in the emissions is converted to CO₂ through flaring. The prior fate of the BOF exhaust gas is assumed to be flaring, where all the carbon contained in the BOF gas is converted to CO₂ and released to the environment”[74]. The LT process is envisioned to be an independent plant co-located with an existing steel mill. This eliminates any need for transporting feedstock gas to the LT bioreactor.

Table 19: Summary of key input items for the LCA studies for LT-Process as adapted to steel production facilities in Handler et al.

LCA Input Items	LDG - Handler et al, 2016 (1000 kg/h of EtOH production basis)
Database	Ecoinvent
Utilities	
Electricity	Medium voltage (US Grid)
Steam	For chemical processes
Fermentation Inputs	
net gas input ^a	2.12 x 10 ³ kg (CO ₂ eq)

bioreactor nutrient inputs ^b	CaCl ₂ , FeCl ₃ , superphosphate, ammonia, organic chemicals
cooling water	6453 kg water, decarbonated, at plant
fermentation process water	2554 kg tap water at user
sulfatreat	1.86 kg magnetite, at plant
wastewater treatment	1293 kg treatment, sewage whey digestion, class 4
treatment of biosolids	49.9 kg C converted to CO ₂ & CH ₄ 183.1 CO _{2eq} Anaerobic treatment of solid, liquid waste (biomass, ethanol, etc.), conversion of biogas to CO ₂ upon combustion; released in anaerobic digestion emissions
transport of EtOH	100 km Transport, lorry >32 t, EUROS
Combustion of EtOH	1.91 x 10 ³ kg CO ₂ equivalents (CO _{2eq})

This Handler et al (2016) study also considers the LT-ethanol production from biomass (gasified corn stover, switchgrass and forest residues scenarios). The GHG emission from these processes were calculated to be 8.0, 11.7 and 1.5 gCO_{2eq}/MJ respectively and so more prospective (88-98% GHG reductions compared to fossil petroleum gasoline), despite the significant additional GHG emissions associated with the procurement of these feedstocks (6.6 – 14.9 gCO_{2eq}/MJ ethanol)[74]. The much lower GHG emissions associated with LT-EtOH from gasified biomass relative to LDG suggests merit for the establishment of gasified biomass and LDG jointly fed LT-Process facilities, to be ready at hand to utilise all available steel works waste gas, and so to realize more efficient CAPEX.

The findings of the above discussed LCA studies for LanzaTech process are summarized in Table 20. It shows that for ethanol produced from steel mill gases by LanzaTech process, the reduction in GHG emissions are greater than 50% when compared to emission from fossil fuel based production of ethanol.

Table 20: Summary of findings of various LCA studies of LanzaTech Process.

Study Detail	Findings, Assumptions
Feed - Syngas(wood) Study by - Griffin/Schultz (2012) Reference- [72]	GHG emissions: 24.8 lb CO ₂ /gal (2.97 kg CO ₂ /l) GHG Emissions Reductions: 18 % relative to same biomass derived syngas via a conventional thermochemical path [30.2 lb CO ₂ /gal] (3.62 kg CO ₂ /l).
Feed - LDG Study by – E4TECH for LanzaTech Reference- [75, 76].	GHG emissions: 19.6 gCO _{2eq} /MJ(EtOH (as per EU RED method) GHG Emissions Reductions: 76.6 % relative to baseline fossil fuel [83.8 gCO _{2eq} /MJ(EtOH)]
Feed - LDG Study by- Handler et al (2016) Reference- [74]	GHG emissions: 31.4 gCO _{2eq} /MJ (EtOH) GHG Emissions Reductions: 67 % relative to petroleum gasoline [83.8-90 gCO _{2eq} /MJ]
Feed – Steel Mill Gases Study by -Michigan Tech University, E4Tech, LanzaTech	GHG emissions: 25-45 gCO _{2eq} /MJ(EtOH) GHG Emissions Reductions: 50-70 % relative to conventional gasoline [90 gCO _{2eq} /MJ(EtOH)]

Reference- [78]	
Feed- Steel Mill Gases Study by Ou, X., et al for LT process in Chinese steel industry Reference - [80]	GHG emissions: 22.6 gCO ₂ e/MJ gCO ₂ eq/MJ(EtOH) GHG Emissions Reductions: 76 % relative to conventional gasoline [94 gCO ₂ eq/MJ]
Feed- Steel Mill Gases Study- Steelanol Project LanzaTech Process at Ghent Belgium Reference-[81, 82]	GHG emissions: 10 gCO ₂ e/MJ gCO ₂ eq/MJ(EtOH) GHG Emissions Reductions: 87 % relative to conventional gasoline

9.7 BlueScope Steel – Utilization of Steel Mill Gases

As shown in Figure 15, there are many consumers of steel mill gases in an integrated steel plant. Distribution of the SMGs to the consumers is necessarily done on an energy basis. This means the plant needs to maintain the total energy and the calorific value (the Wobbe Index) to each of them. Table 8 provides the various processes where SMGs are used in BlueScope's Port Kembla Steelworks. Currently there is no consumer for LDG and all the LDG is flared at BlueScope. Therefore, LDG is a focus of any utilization process. Table 21 provides total generation and consumption of SMGs at BlueScope.

Table 21:- Generation and consumption of SMGs at BlueScope Steel (courtesy BlueScope)

	BFG	LDG	COG	NG
Av. Flow [Nm ³ /hr]	417021	27708	86318	
min. Flow [Nm ³ /hr]	359084		59776	
max Flow [Nm ³ /hr]	475363		97340	
Composition				
CO [mol %]	24.61	64	5.5	
CO ₂ [mol %]	22.94	18	1.8	1.5
N ₂ [mol %]	48.77	17	1.8	1.5
H ₂ [mol %]	3.24	0.8	62.8	
O ₂ [mol %]			0.1	
CH ₄ [mol %]			25.5	94.2
C ₂ H ₆ [mol %]			2.5	2.8
Ar			0	
Usage				
Coke Oven batteries [%]	39.9		11.8	
PCI system [%]	0.9			
Blast furnace stove, Cowper [%]	16.9		15.6	3
Boiler [%]	38.8		25.0	27
Slabmaking [%]			9.3	
Plate mill [%]			6.4	
Sinter plant [%]				10
Hot strip mill [%]			25.4	
Others [%]				62
Flare [%]	3.1	100	8.7	

9.7.1 Methanol Production from SMGs (Chemical Process)- BlueScope Case

The process developed by Thyssenkrupp (T-K) to produce methanol from SMGs was collaboratively investigated by Thyssenkrupp, BlueScope Port Kembla Steelworks and CO2CRC for its application at BSL and to help better understand its GHG reduction potential.

Table 21 lists the total availability of SMGs at BSL. LDG and BFG are a good source of COx, and COG is a good yet limited source of H2. It is generally considered that methanol production via equation Eq. 12 is more important for the use of BSL’s LDG and COG which are CO rich, whereas production via Eq. 13 is considered more important for the use of BSL’s BFG which is CO₂ rich. The data highlight the availability of all the LDG as a carbon source. The data also indicate the limited availability of the COG and so the interest for the integration of additional external H2 to maximise utilisation of the carbon available in the LDG. It is noted that, for each path, clean up and purification of the waste gas streams is considered essential to avoid catalyst poisoning and de-activation.

Thyssenkrupp modelled and simulated the methanol production process with an objective to maximize the use of available LDG. A major assumption was made that all 86.3 kNm³ of COG produced is available for the process to provide required hydrogen. This assumption may not be valid as BSL is using nearly all the COG produced for various processes with in the steel plant as shown in Table 21. Nevertheless, the model provides a good insight into the methanol production by utilizing steel mill gases.

Two scenarios have been considered for methanol production from SMG.

Scenario 1- This scenario utilizes LDG as a carbon source and all COG produced at Port Kembla Steelworks as source of H₂. No H₂ is available from any other source. Figure 27 shows the configuration for this scenario.

Scenario 2- This scenario utilizes LDG as a source of carbon and all COG produced at Port Kembla Steelworks as source of H₂ and to maximize the utilization of LDG, additional external H₂ is made available from electrolysis process preferably based on cheap and renewable electricity as shown in Figure 28.



Figure 27: Configuration of Methanol production process using steel mill gases for Scenario 1.

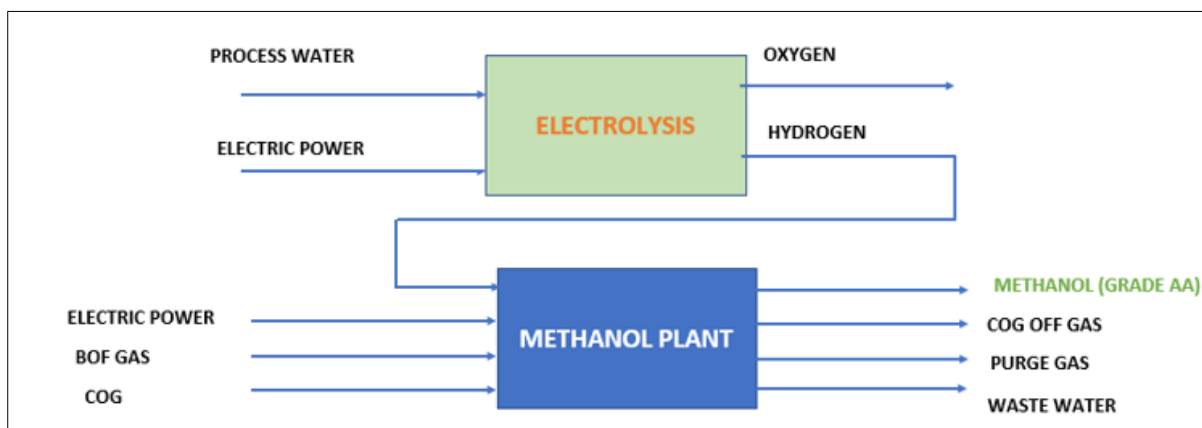

Figure 28: Configuration of Methanol production process using steel mill gases for Scenario 2

Due to limited availability of H₂ in scenario 1, the process can only utilize a part of available LDG to produce methanol. This scenario uses 19.5 kNm³/h of LDG and all of COG (86.3 kNm³/h) to produce 200,000 mtpa methanol. Scenario 2 sources additional H₂ and utilizes the all available LDG (26.7 kNm³/h) and all of COG and 13.8 kNm³ of hydrogen from electrolysis process to produce 275,000 mtpa. The process utilizes only 13.5 and 15.1 % of the total SMG carbon content in scenarios 1 and 2 respectively.

Table 22 summarily lists Boundary, Stream and GHG Emission data for each of the two different scenarios. These results show that the TK-Process can be useful to provide GHG emissions reductions of 275,000 tCO₂/y and 376,000 tCO₂/y for case scenarios 1 and 2 respectively, via transformation of the SMG (LDG + COG) carbon content into methanol. These constitute 33.1 % and 40.0 % reduction in the SMG carbon emissions as processed respectively. That scenario 2 was found to lead to greater MeOH production (more CO₂ emission avoidance) than scenario 1 is consistent with the greater amount of carbon provided in the feed, and the provision of additional external H₂, and the greater overall capacity potential of the plant. These results also show that each process led to near identical COG Off-Gas and Purge Gas compositions, despite the different supply gas configurations, consistent with the same underpinning chemistry.

These results show that scenario 1 leads to a net CO₂ emissions reduction of 359,451 mol/h (138,262 tonne/y) consistent with a 16.6 % CO₂ emissions reduction with respect to combustion of gases for energy purposes, whereas scenario 2 leads to 25.9 % CO₂ emissions gain of 629,330 mol/h (242,070 tonne/y). However, it is noted that scenario 2 would lead to a 11.4 % CO₂ emissions reduction of 277,462 mol/h (106,725 tonne/y), were the electrolyser to run GHG emission free (i.e. solar powered).

The TK-Process was calculated to produce MeOH via scenarios 1 & 2 with GHG emissions of 3489 and 4319 gCO₂eq/kg MeOH respectively. These equate to GHG emissions per unit energy value of MeOH of 154 and 190 gCO₂eq/MJ MeOH respectively (118 gCO₂eq/MJ MeOH for scenario 2 with solar H₂). Accordingly, for each case the production of MeOH via the TK-Process was found to incur more GHG emissions than as per steam methane reforming (SMR) [~38 gCO₂e/MJ MeOH] process to produce methanol [70].

Preliminary LCA of the TK-Process was conducted by considering the energy demand of the methanol plant and the electrolyser and assuming a 1 MW power requirement for gas cleaning. The current grid (NSW) emissions intensity factor of 0.82 tCO₂e/MWh [9] was applied. Credit was allowed for the CO₂ that would otherwise be emitted by flaring the LDG and COG, and a small amount of 3.5 g CO₂/MJ amount was added to allow for transport.

Accordingly, the TK-Process was determined to incur net MeOH CO₂ emissions of 15.1 and 84.7 g CO₂/MJ for case scenarios 1 and 2 respectively; the substantially higher emission of the latter being due to the power requirement to run the electrolyser. Scenario 2 incurs slightly less emissions (12.0 g CO₂/MJ) assuming zero emission for solar H₂. So each scenario was found to incur substantially less GHG emissions per unit heating value than for MeOH production via SMR [~38 gCO₂e/MJ[70]] and methanol based transport fuels [43-74 gCO₂e/MJ[70]]. This is attributed mainly to the GHG emissions credit savings possible for the utilization of SMG which would otherwise be flared. On this basis MeOH production via TK-Process as adapted to the BSL plant would be preferred. The substantial heating value contained in the COG Off-gas and Purge Gas could provide for even further GHG emissions reductions, and potentially offer a path for net emission free (consuming) MeOH production. However, these findings are based on very crude LCA and so should be interpreted accordingly. More

comprehensive LCA analysis is recommended to better understand the real potential of GHG emissions reductions for methanol production from SMG.

Table 22: Boundary, Stream and GHG Emission data for the assessment of TK-MeOH from Port Kembla Steelworks' SMG [Source: Thyssenkrupp (BlueScope Steel, 2019) and CO2CRC]

		Scenario 1	Scenario 2
Methanol Plant			
Capacity [mtpa]		~200,000	~275,000
Input	Electrical power [MW]	18	22.3
	H ₂ [kNm ³ /h]		13.8
	LDG [kNm ³ /h (%)]	19.5	26.7
	COG [kNm ³ /h]	86.3	86.3
Output	Methanol [mtpd]	548	749
	COG Off-Gas [kNm ³ /h]	48.9	48.9
	Purge-Gas [kNm ³ /h]	4.2	5.7
	Waste Water [t/h]	2.6	3.6
Electrolyser			
Input	Electrical Power [MW]		62.8
	Process Water [t/h]		11.1
Output	H ₂ [kNm ³ /h]		13.8
	O ₂ [kNm ³ /h]		6.9
COG Off-Gas ^a	Volume Flow [kNm ³ /h]	48.9	48.9
	Lower Heating Value [MJ/Nm ³]	6.67	6.67
Purge Gas ^a	Volume Flow (kNm ³ /h)	4.2	5.7
	Lower Heating Value [MJ/Nm ³]	4.64	4.67
GHG EMISSION DATA			
	Carbon content of SMG bound into MeOH [tCO ₂ /y]	275,000	376,000
	CO ₂ Emissions without TK-process, i.e. business as usual case (MMT/y) ^b	6.20	6.20
	Total Power for Process (MW) ^c	19	86.1
	CO ₂ Equivalents to Power Process (mol/h) ^d	354,091	1,604,591
	Total C content of feed gas (molC/h)	2,170,152	2,433,723
	GHG Emissions Avoided as C bound in MeOH (molCO ₂ /h)	713,542	975,260
	Net Total CO ₂ Emissions for TK-Process (mol/h) ^e	1,810,701	3,063,054
	GHG Emission Reductions (molCO ₂ /h)	359,451	(629,330)
	GHG Emissions per MeOH Production (gCO ₂ eq/kg MeOH)	3489	4319
	GHG Emissions per MeOH Production (gCO ₂ eq/MJ MeOH)	154	190
	Net Life Cycle GHG Emissions per MeOH Production (gCO ₂ eq/MJ MeOH) ^f	15.1	84.7

^a Gas stream composition given as dry mol.%.

^b i.e. Business as usual case with flaring as reported by BSL.

^c Power requirement to run Methanol plant and Electrolyser, and for gas cleaning as per LT-Process assessment.

^d Excludes potential vast emissions savings for LHV of COG Off-gas and Purge gas (assumes emissions factor of 0.82 tCO₂/MWh).

^e Based on the methanol amount production potential reported (mtpd) and the reported total CO₂ emissions for BSL (6.2 Mt/y).

^f The molar SMG carbon flow through the process per mass MeOH production, i.e. SMG carbon not converted in to MeOH.

9.7.1.1 Cost Analysis

Cost estimation of methanol production process was provided by Thyssenkrupp based on the input from CO2CRC. assume operating hours = 8,500 h/a, 1 EUR = 1.61 AUD, a 2019 cost basis excluding prices escalation, and accuracy of TIC +/- 60 %, but do not include costs for CO₂, a sales premium for the sustainably produced chemical products and the value of the oxygen produced by the electrolyser. Scenario 1 was estimated to require an initial 318 million \$AUD CAPEX to then give revenues of 87 million \$AUD per annum with a cost of electricity 13 million \$AUD per annum. Scenario 2 was estimated to require 467 million \$AUD CAPEX to then give revenues of 119 million \$AUD per annum with a cost of electricity of 45 million \$AUD per annum. The CAPEX and revenues estimated for Scenario 2 are both greater than those estimated for scenario 1 consistent with the larger production

volume of the plant. On this basis the process should be considered favourable. However, it is recognized that these initial estimates only represent a rough compilation of the envisaged CAPEX, electricity costs and revenues, and so do not provide full LCA, excluding for example CO₂ costs, a premium for the sale of sustainably produced chemicals, and revenues for the Oxygen produced.

9.7.1.2 Concluding Remark

Application of Thyssenkrupp process to produce MeOH depends on availability of hydrogen either from COG or pure hydrogen from carbon free source. With the current management of COG at BlueScope, sufficient COG is not available that makes the process economically non-viable.

9.7.2 Ethanol Production from SMGs (Bio-chemical Process)- BlueScope Case

The LanzaTech process to produce ethanol from SMGs was investigated by CO2CRC with inputs from LanzaTech and BlueScope. The focus was to utilize LDG which is currently flared at BSL. The LDG at BSL is almost H₂ free and vary in composition and availability due to batchwise operation of the basic oxygen furnace. There is no LDG holder at BSL to ensure continuous uninterrupted supply of LDG to LT process. The availability of BFG and COG gas streams are limited given the existence of various consumers of these gas streams within the plant although BSL has separate gas holders for BFG and COG.

It is proposed to redirect SMGs and combine BFG and COG with the LDG, and deoxygenated, to provide a more optimal H₂ bearing and oxygen free waste gas blend to the anaerobic fermenter. The arrangement uses LDG to raise the calorific value of the BFG during periods of LDG generation, allowing COG to be released from individual consumers to be directed to the LanzaTech process. Figure 29 is schematic of such an arrangement.

A booster fan draws LDG produced in the basic oxygen furnace through a gas scrubber for cleaning. The cleaned LDG is ducted to mix with clean BFG from blast furnace 5, with the mixture supplied to the blast furnace stoves, boilers and coke ovens. Some of the mixture is blended with cleaned COG and directed to the LanzaTech plant. As the reaction in the fermenter is an anaerobic reaction, oxygen is not a desired component in the feed. Ethanol is produced in the fermenter. The production of EtOH from CO as generally described by Eq.16 is exothermic and so cooling via water is applied to the fermenter vessel. The ethanol is then recovered from the broth by steam distillation. Low value waste heat, unsuitable for other processes in the steel plant can be used for distillation.

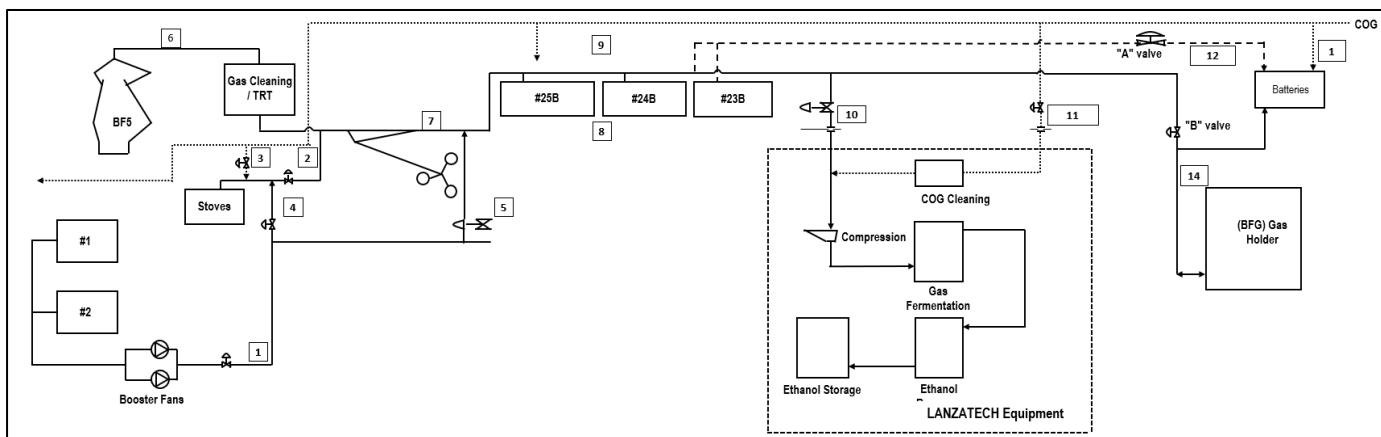

Figure 29: Schematic for steel plant gases utilization using LanzaTech technology for BlueScope Steel (Source: BlueScope Steel)

The input parameters given in Table 23 for the process were determined by Lanzatech and BSL as suitable to assess the technical and financial viability of the process i.e. suitable to maintain the energy requirements of the various other consumers and accommodating the varying LDG generation rates.

Table 23: Parameters determined by LanzaTech and BSL to be suitable to assess the technical and financial viability of the LT-Process integrated with Port Kembla Steelworks

Feed	Proposed LDG
Av. LDG captured	27708 Nm ³ /h
Av. LDG accepted	27193 Nm ³ /h
Max. LDG captured	197139 Nm ³ /h
Aim total flow to fermenter	32968 Nm ³ /h
Av. BFG consumption	5791 Nm ³ /h
Max BFG flow	20019 Nm ³ /h
Av. LT supply % CO	57.3 %
Av. CO % in LDG	67.78 %
Av. CO to fermenter	18879 Nm ³ /h
Ethanol Production	5267 Kg/h

Using gas composition in Table 4, gas flow rates in Table 23 and equations 16 & 17, the maximum theoretical amount of ethanol produced by the BSL LT-Process was calculated. The hydrogen available in the feed gas converts CO₂ in the feed gas and CO₂ produced by reaction equation 16 to ethanol. To convert all the CO in the feed gas to ethanol by LT process, stoichiometrically the feed should have CO and H₂ in the ratio of 1:2. If there is more H₂, that will convert CO₂ in the feed gas to ethanol by reaction eq. 17. As shown in Table 21, there is no H₂ in LDG and in BFG H₂ to CO ratio is 1:7. Therefore, the CO₂ flow in the tail gas from LT process using gas flows given in Table 24 will be greater than that in the feed gas. Assuming conversion efficiency of 80% for reactions in equation 16 & 17, estimated performance, process parameters and CO₂ emission data is calculated and shown in Table 24

In case of BlueScope, the LT-Process was estimated to have the potential to provide a 14 % reduction of the carbon content of the steel mill waste gas utilized which would otherwise be emitted to the atmosphere via business as usual flaring. The reduction can be somewhat increased with the use of low carbon electricity for LT process and additional H₂. However, this reduction of 0.53 Mt/y is only 0.9 % with respect to Scope 1 emissions of 6.27 Mt/y at BlueScope.

Table 24: Gas streams and estimated emission for the assessment of LT-EtOH from Port Kembla Steelworks SMGs [Source: BlueScope Steel and CO2CRC assessment]

	Proposed
LT-Process Feed Gas ^a	LDG/BFG
Volume Flow (Nm ³ /h, 1 atm, 0 °C)	32698
CO (%)	57.1
H ₂ (%)	1.2
CO ₂ (%)	18.9
N ₂ (%)	22.8
O ₂ (%)	0.4
Process Tail Gas	
Volume Flow (Nm ³ /h, 1 atm, 0 °C)	27350
CO (%)	13.68
H ₂ (%)	0.29
CO ₂ (%)	58.69
N ₂ (%)	27.34
O ₂ (%)	
Process Data	

Av. CO to fermenter (Nm^3/h)	18828
Av. CO ₂ to the fermenter (Nm^3/h)	6223
Av. H ₂ to the fermenter (Nm^3/h)	405
Conversion Efficiency (%)	80
Ethanol Production (<i>tonne/h</i>)	5.267
Microbial Biomass Solids (<i>tonne/h</i>)	
Treated Waste Water (<i>tonne/h</i>)	14 ^c
CO ₂ in Tail Gas (<i>mol/h</i>)	721300
Net CO ₂ Produced in Fermenter (<i>mol/h</i>)	443478
Total Power for Process (MW) ^d	7.3
CO ₂ Equivalents to Power Process (<i>mol/h</i>) ^e	136045
Total CO ₂ Produced by Process (<i>mol/h</i>)	579523
GHG Emission Data	
Net Total CO ₂ Emissions for Process (<i>mol/h</i>)	857345
CO ₂ Emissions without LT-process (<i>mol/h</i>) ^f	995458
GHG Emission Reductions (<i>molCO₂/h</i>) ^g	138113
GHG Emissions per EtOH Production (<i>gCO₂eq/kg EtOH</i>) ^h	7163
GHG Emissions per EtOH Production (<i>gCO₂eq/MJ EtOH</i>) ^h	242
Net Life Cycle GHG Emissions per EtOH Production (<i>gCO₂eq/MJ EtOH</i>) ⁱ	29

9.7.2.1 Cost Analysis

LanzaTech has done the cost estimation of producing ethanol from SMGs for BlueScope and shared this highly confidential information with BlueScope and CO2CRC. The estimated CAPEX includes:

- ISBL Cost- Gas treatment, Gas compression, bio reactor, product recovery and waste water treatment section.
- OSBL Cost- Electrical, buildings, firefighting and instrument air facility

The total CAPEX was estimated to be in the range of 130-150 million Australian \$. Over this cost BlueScope has estimated the cost of gas pipe run to facilitate supply of SMGs to an Ethanol plant. Adding the contingency and engineering cost, the total estimated capital requirement is in the range of 250 -280 million Australian \$.

The operating cost includes costs of electricity, cooling water, process water, cost of proprietary microbes, annual maintenance, direct labour, insurance and overheads.

The total cost of ethanol production was estimated to be 0.2 to 0.25 Australian \$/litre.

The total revenue obtained from sale of ethanol is adjusted for the revenue lost due to redirecting BFG and COG that would have used for meeting energy demand in steelmaking to ethanol plant.

Capex/Revenue for ethanol production is estimated to be between 5 to 5.3. The Steel industry is encompassed within the Metal and Mining by GICS industry classification which has a medium CapEx/Revenue of 6.3 and 80th percentile of ~17.5 [83]. Furthermore, the CapEx/Revenue ratios of its peer Chemicals (traditionally classification for EtOH production) and Electric Utilities classifications are 5.1 and 13.0 respectively [83]. These ratios are based on data collected for the 2010-2015 period [83]. On this basis the ethanol from LanzaTech Process should be considered favourable. This study provided description of ethanol production from biochemical process developed by LanzaTech by partial utilization of the available carbon content of its high CO laden LDG waste gas. Various LCA studies has established the GHG reduction potential of LanzaTech process in the range of 50-90% when compared to ethanol production by traditional use of fossil fuel. The total LCA GHG emission of LanzaTech process is 20-30 g CO₂ e/MJ. The GHG emission for BlueScope case is expected to be in this range for ethanol production. LCA depend on the location, process and raw material used in the steel

making. So, LCA specific for Bluescope is warranted to determine the net benefits of the LT process for BlueScope.

9.7.2.2 Conclusion on LanzaTech Process

For BlueScope, the LanzaTech Process has the potential to provide 10-15 % reduction of the carbon content of the steel mill waste gas utilized which would otherwise be emitted to the atmosphere via business as usual flaring. The reduction can be somewhat increased with the use of low carbon electricity for LT process and additional H₂. However, this reduction is only 0.6 %-0.8% with respect to overall total emissions of 6.2 Mt/y at BlueScope. Therefore, other options like carbon capture, top gas recycling of blast furnace with carbon capture need to be explored to achieve deeper cuts in emission. These options are not mutually exclusive with the LanzaTech process.

A preliminary cost estimation that can be termed as a Class V estimate with accuracy typically $\pm 30-50\%$ or worse was performed. A more accurate and detailed cost analysis with sensitivity analysis need to be performed before making any decision on investment.

This study finds that the LanzaTech process fulfils the new steel mill gas utilization concepts that can reduce overall CO₂ emissions through the life cycle, is safer and ecofriendly and is potentially economically viable. This study shows that the economic feasibility of CO₂ re-use options relies on the efficiency of carbon conversion, the value of the intended products and the availability of cheap renewable power and in some cases, hydrogen.

9.8 Applicable Energy Efficiency Measures

CO₂ emission reduction in steel production can be achieved by employing suitable measures from currently available energy efficiency technologies. This section describes the energy efficiency measures in the Iron and Steel industry. All energy efficiency measures reduce fuel consumption and, therefore, lead to a reduction in overall CO₂ emissions related to fuel. In 2013, the Environmental Protection Agency (EPA) of US has listed over 60 energy efficiency measures available for integrated steel production in the US and further categorised these measures with respect to payback period, and applicability to existing steel plants. LAWRENCE BERKELEY NATIONAL LABORATORY, USA identified and analysed 25 energy efficiency technologies and measures applicable to the processes in the Indian iron and steel industry and 23 energy efficiency measures for steel industry in China. The discussion on energy efficiency is based on published studies and research articles and reports from various reputed institutions [11, 84-93].

During the last 50 years, Australia's steel industry has moved from 100% ingot casting to 100% continuous slab casting, improving yields and saving about 25% of the energy formerly required to make slabs.

9.8.1 Coke Dry Quenching

Coke Dry Quenching (CDQ) uses an inert gas in place of the traditional water spray to cool coke. This process allows the recovery of the thermal energy in the quenching gas. The coke produced by CDQ has better quality that could improve blast furnace operation and allow a minor reduction in furnace

coke consumption due to a slight increase in tuyere pulverised coal injection and a slight reduction in coke dust losses from the furnace top. CDQ is widely applied in Japan and Korea and suitable for India and China. But there are few CDQ installations in the EU, the US and Canada, due to a very long payback period of 35 years, primarily due to low electricity prices.

9.8.2 Coal Moisture Control

Reducing moisture in the coal from 8-9% to 3-5% in coke making reduced the fuel consumption in coke oven by approximately 0.13 to 0.2GJ/tonne coal. The coal moisture control can also improve coke quality by increasing its strength. The moisture in the coal can be controlled using low pressure steam or sensible recovery from COG. However, the US EPA has estimated 50 years for the payback of this technology [93].

9.8.3 Pulverized Coal Injection

Pulverized coal injection (PCI) is blowing a large amount of pulverized coal into blast furnace tuyeres, reducing the coke requirement of the blast furnace. Limit on PCI depends on coal type, coke quality and furnace configuration. For every tonne of PCI, 0.85 to 0.95 tonne of coke production can be avoided and energy savings of 3.76 GJ/tonne of coal injection can be achieved [85]. The payback period for this technology is very attractive at 2 years [93]. BlueScope Steel has implemented this energy efficiency measure and Port Kembla Steelworks has pulverized coal injection system in operation.

9.8.4 Natural Gas Injection

Natural gas tuyere injection in a blast furnace has benefits of replacing some CO by hydrogen as the reducing agent, leading to lower CO₂ emission. 0.9 to 1.15 tonne of natural gas can be injected per tonne of coke to provide an estimated saving of 0.9 GJ/tonne of hot metal [94]. The payback period depends on price of natural gas and is estimated to be 1.3 years for a blast furnace with no tuyere injection.

9.8.5 Top Pressure Recovery Turbines

Blast furnace gas (BFG) has a pressure of 0.2-0.236MPa and temperature of 100-120°C at the furnace top (at Port Kembla Steelworks). A Top Pressure Recovery Turbine (TRT) converts the physical energy of high-pressure blast furnace top gas into electricity by using an expansion turbine. The key to TRT is to secure stable expansion blast furnace gas in an expansion turbine without impacting blast furnace operation. Use of TRT can generate 40-60 KWh/tonne of pig iron [95]. If TRT were installed worldwide at all the furnaces working at elevated pressure, CO₂ emissions can be reduced by 10 Mt/year [94]. This technology is particularly suited for the new plants, as the retrofitting of existing blast furnaces may not be easy. According to NEDO, the cost of 7MW TRT for 1 Mtpa blast furnace is estimated to be recovered in 1.8 year [96].

In 1981 BlueScope steel achieved a major energy saving with the installation of a top gas recovery turbine on the blast furnace 5.

9.8.6 Heat Recovery from Hot Blast Stoves

The exit temperature of flue gases from hot blast stoves is above 200-250 °C [86]. The heat can be recovered to preheat combustion air or fuel for the stoves. Fuel saving of 0.35 GJ/tonne of hot metal can be achieved by preheating [93]. Japan has achieved 0.125GJ/t-pig iron energy saving in a 1 Mt/y

BF system by recovering 40-50% of the sensible heat from the stove flue gases [96]. According to IEA, global application of this technology could potentially reduce CO₂ emissions by 20 Mt annually [90].

9.8.7 BOF Bottom Stirring

BOF bottom stirring is also called combined blowing. It is one of the major innovations in steel making. In this process a small amount of inert gas is introduced from the bottom of the converter to accompany oxygen injection through the top vertical lance. The process results in improved yield, lower loss of iron to slag, lower oxygen in steel and improves vessel life. [94]. BlueScope Steel's basic oxygen furnace operates on combined blowing.

9.8.8 BOF Heat and Gas Recovery

The gas produced in BOF (known as converter gas) has a temperature of around 1200 °C and CO content of 65–70%. The gas has both sensible and latent heat. Recovery of sensible and latent heat provides a huge opportunity for energy saving. Two heat recovery methods can be applied. In combustion heat recovery, the CO leaving the furnace is allowed to combust by letting large amounts of air to enter the exhaust hood. The resulting hot gas from the combustion is then used in a heat recovery boiler to produce high pressure steam. In non-combustion heat recovery only, the sensible heat of the gas is first recovered in waste heat boiler and the cool gas used as a fuel in boiler plant directly or after mixing with BFG/COG. According to NEDO, 0.125GJ/tonne of steel can be recovered by combustion method and 0.55-0.92 GJ/tonne of steel can be recovered by non-combustion method depending on use of steam [96]. Arcelor Mittal's steel plant in Ghent Belgium has achieved an estimated energy reduction of 3% and CO₂ reduction of 170,000 tonnes/year through heat recovery from BOF gas [94]. The estimated pay back for this process is between 8 to 15 year [93, 96].

At BlueScope steel's Port Kembla plant, the BOF gas is sent to flare without utilizing the heat content of the gas.

9.8.9 Waste Heat Recovery in Sinter Plant

Heat recovery from hot air streams both from sinter cooler and sinter machine can be used for steam generation in recovery boilers. NEDO reported the energy saving of 47 KJ/tonne of sinter by applying heat recover from sinter plant, US EPA has reported fuel saving of 0.55 GJ/tonne of sinter and additional electricity generation of 1.4kWh/tonne sinter with retrofitted heat recovery from a plant in Netherlands.

9.8.10 Improved Ladle Preheating

The ladle of BOF requires preheating to avoid temperature drop when filled with steel. Gas burners are used to preheat the ladle. The ladle heating can be improved by having efficient burner management system, temperature monitoring and installing hoods to reduce radiative losses. Use of recuperative and oxy-fuel burners can improve preheating. A 16% reduction in the fuel consumption is reported by JFE Steel Japan by improving ladle preheating and with control of blowers in BOF process [93, 96].

9.8.11 Thin Slab Casting & Strip Casting

Thin slab casting is a mature technology and available commercially. In thin slab casting, the steel is cast directly to thin slabs of thickness 30 to 60 mm against the conventional thickness of 120-300 mm. With thin slab casting, the estimated energy saving is 4.9 GJ/tonne of crude steel with payback period of 3.3 year [93].

In Strip Casting process, thin strips (0.8 mm to 2.0 mm) are made by casting steel between two rolls. Strip Casting leads to considerable saving in capital cost and energy and reduce material losses. The potential energy saving is 80 to 90% over conventional slab casting and hot rolling [95]. However, thin slab casting and strip casting are more suitable for new plants as major changes in existing plants are required and at the expense of flexibility in production.

In 1999, IHI and BlueScope jointly developed and succeeded to cast 40 tonnes of carbon steel at Port Kembla Steelworks using twin roll strip caster.

9.8.12 Variable Speed Drives

Variable speed drives enable better matching of speed of rotary equipment with load variation. VSDs can be more cost effective for batch processes like iron and steel making. In an integrated steel plant VSDs can be employed on flue gas control, fans and pumps. VSD on ventilation fans of BOF can reduce energy consumption by 1.0kWh/tonne of steel. Based on UK experience, VSD on flue gas systems can save 0.06GJ/tonne of steel with payback period of 2 to 3 year.

BlueScope Steel has numerous VSDs on rotary equipment.

9.8.13 Other

BlueScope Steel and Australia's other integrated steel company, together with the Centre for Sustainable Minerals Processing and CSIRO, have established an Australian program of scientific work to develop technologies that will significantly decrease the net GHG emissions in chosen applications. BlueScope has completed two extensive projects: The Use of Biomass in the Iron and Steel Industry and Heat Recovery from Molten Slag Through Dry Granulation to improve energy efficiency and CO₂ reduction in steel making.

9.9 Process Modifications

CO₂ emissions from the combustion of gaseous fuels occur from numerous individual stacks. It is likely that post combustion capture of CO₂ would only occur at one or a small number of the large emitter stacks. Significant modifications would be required to divert flue gases to capture equipment and direct the captured CO₂ to its intended destination, and to return the remaining flue gas to the stack. In many cases, limited real estate is available to locate the additional capture equipment and associated ductwork. Scheduling outage time to allow the connection of the new equipment into the existing facilities would also be challenging in some areas e.g. coke ovens where the coke batteries need to maintain in a hot state and so the stack is not taken out of service.

Significant blast furnace modifications to allow CO₂ capture from the total BFG stream before it leaves the blast furnace, or any process involving recycling of CO₂ removed top gas back into the furnace, would need to be carried out during a blast furnace reline, which occur approximately every 15-17 years.

Processes which use BFG, COG or LDG to create valuable chemicals would require cut-ins during scheduled outages to provide those fuels to the new facilities. If changes were made to the fuel reticulation system e.g. blending LDG with BFG, gas quality monitoring and control system upgrades would be required at current BFG consuming facilities

While BlueScope generates power from surplus by-product gases, the steel works is a net consumer of power from the external network. Any new processing equipment would result in additional purchased electricity.

10. Pathways to Emission Reduction

Emissions from integrated steel plants are ‘hard to abate’ emissions. Steel plants are assets of large proportions and with long life span of greater than 50 years, steel plants have the potential to “lock in” emissions for decades. In previous sections, a portfolio of technologies is discussed to reduce CO₂ emissions from steel making. Even with various global initiatives, from dealing with waste gases, process modifications to rethinking core metallurgical equations (use of hydrogen in place of carbon bearing coal or char), experts say a large-scale decarbonisation of the steel industry remains decades away. According to David Clarke, chief technology officer of ArcelorMittal from 2016 to 2019, in principle there are technology routes to lower emissions from steelmaking and society would have to accept higher costs of steel production. “There are two ways you could reduce the carbon footprint,” said Ms Nicole Voigt of Boston Consulting. “One is you avoid CO₂ in the steel production, so you try to use either scrap, or something other than carbon as a reductant agent. “Or, you use end-of-pipe technology, which is carbon storage or usage. The question is which way to go — it’s still debated, though you could argue [the latter] is more feasible.”[97].

Despite the tags like ‘hard to abate’ and ‘lock in’ emission for steel making, steel plants are implementing ways to reduce CO₂ emissions based on the best available technologies and the development status of new technologies. This section discussed the possible pathways for reducing emissions in steel making.

10.1 Pathway- Improving Energy Efficiency

As shown in Figure 20, energy efficiency and implementation of BAT has the greatest potential to reduce CO₂ emission from steel making processes. With BAT, the energy requirement of steel making is approaching the thermodynamic limit. However, the difference between the industry’s average and the practical minimum energy requirements is 31% for ore-based steelmaking and 47% for EAF steelmaking [86]. The significance of energy efficiency cannot be underestimated as energy constitutes a significant portion of the cost of steel production, from 20% to 40%. Also about 9% of the total energy required to produce the steel in the BF-BOF is consumed indirectly for the mining, preparation, and transportation of raw materials [3]. According to International Energy Agency with 2007 as the base year, technically the total potential energy saving in the iron and steel industry is 133 Mtoe, equivalent to 421 Mt CO₂, however economic potentials are significantly below these levels as achieving these savings will require re-build or major refurbishments [98].

The energy saving potential of various technologies discussed in section 9.8 is shown in Figure 30. It shows that power plants and coke making are the two areas of highest energy saving potential [99].

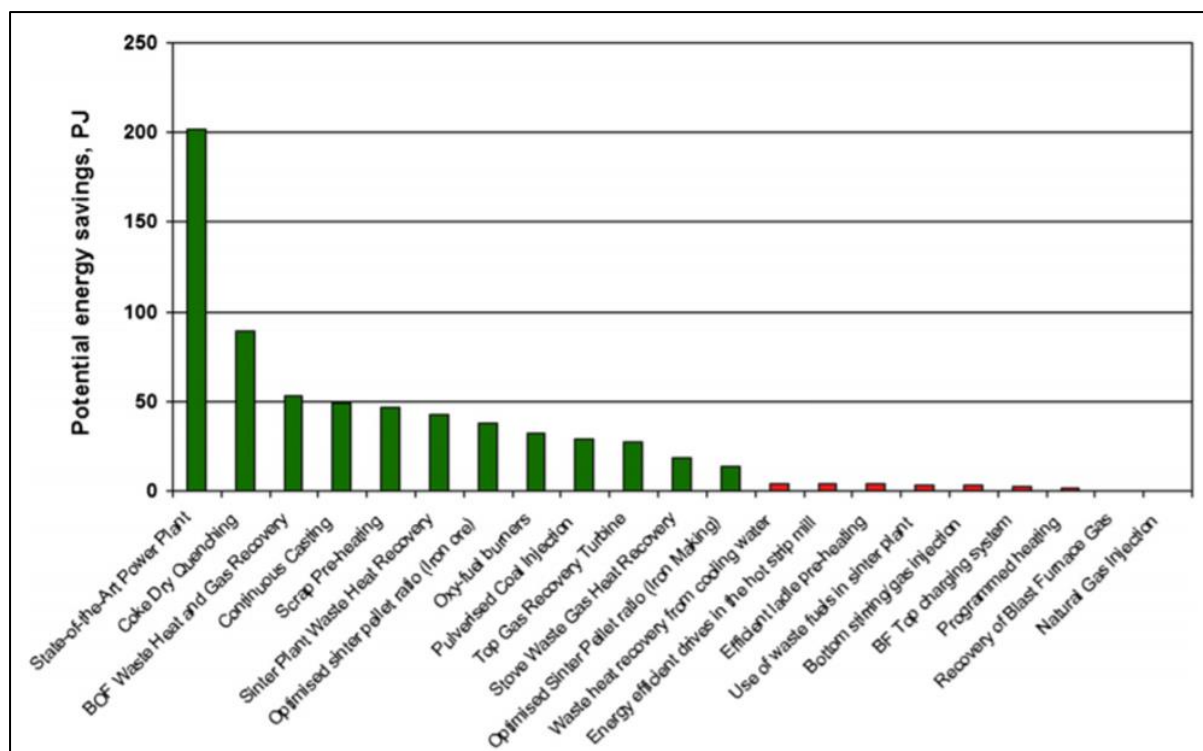

Figure 30: Energy saving potential of various energy efficiency measures

BlueScope's Port Kembla Steelworks have employed various energy efficiency measures but there is scope of adopting BAT in power generation and coke making process. The average efficiency of the conversion of energy of SMGs to electricity is currently 32%. With state of the art power plants, the energy efficiency can be improved by 2 to 3 % points. BlueScope utilizes SMGs (BFG and COG) along with natural gas (when commercially viable) for power generation. The estimated efficiency of power plant at BlueScope is around 29% which is below the average value. Therefore, power generation is the potential area of improvement for BlueScope. BlueScope is still using traditional water quenching to quench the red-hot coke at around 1200 °C from coke oven to below 80 °C. Use of inert gas in coke quenching is more energy efficient and provides better quality coke for the blast furnace.

Under an Energy Efficiency pathway, BlueScope can implement improvements in power plant and other processes where feasible and economically viable. These along with utilization of LDG, will address the 3 most energy saving potential measures for BlueScope. All three measures are well proven and has been demonstrated successfully. These measures will supplement BlueScope's continuous efforts to improve energy efficiency wherein they have already successfully implemented other measures like pulverised coal injection, continuous slab casting and top pressure recovery turbines.

Figure 31 shows the CO₂ emission intensity for different production processes [100]. For BF-BOF route, the average emission intensity (Scope 1 + Scope 2) is approximately 2.3 tonne CO₂ /tonne of steel. Current BF-BOF steelmaking facilities must be looking to minimise emissions through application of best available technologies, with the aim to achieve an intensity of 1.9 tonne CO₂ / tonne of steel. World Steel have developed their Step-Up Program to assist steelmakers to do this. BlueScope has joined this program.

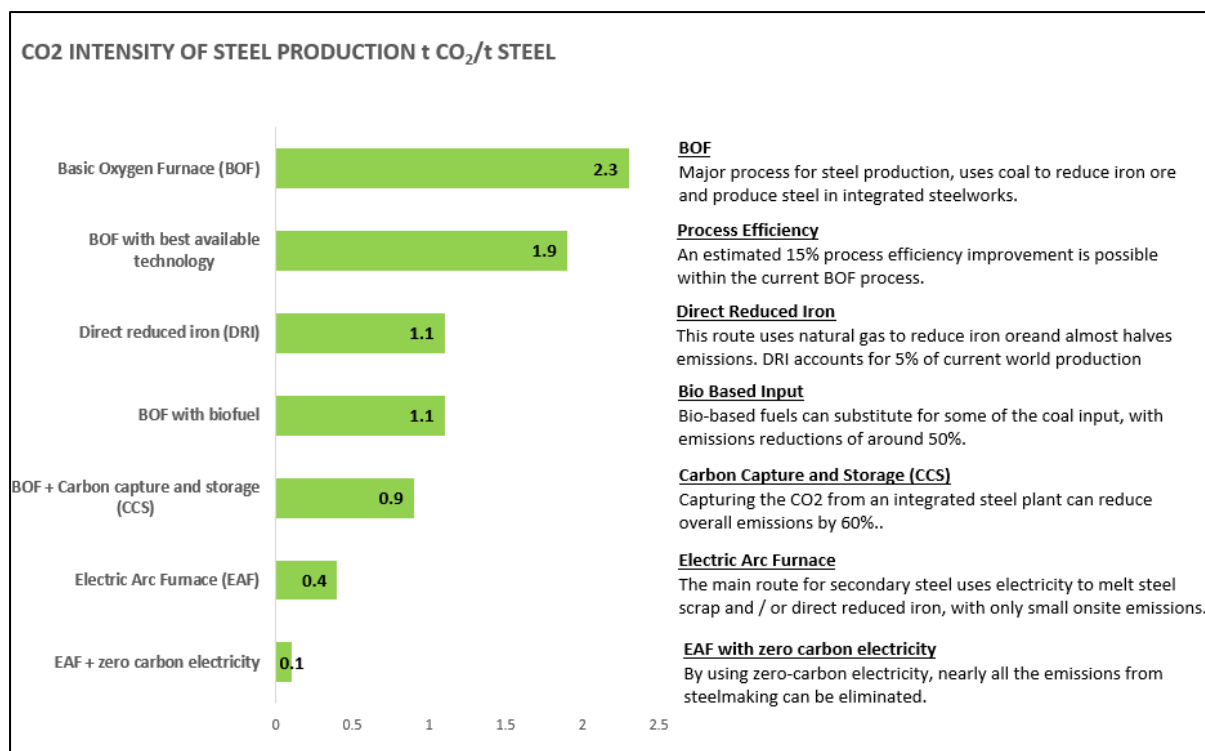

Figure 31: CO₂ emission intensity for different production methods in steel making process [100].

10.2 Pathway -Carbon Capture Storage Utilization

Among the available technologies to reduce CO₂ emission from steel making process, Carbon capture and storage (CCS)/carbon capture utilization and storage (CCUS) can play a critical role in reducing steel sector CO₂ emissions. Carbon capture is a well-developed technology and already been implemented successfully in large scale projects including steel industry. Refer Figure 16 for the status of CCS technologies. Carbon capture in the steel plants can be implemented both as a process modification and as an end of pipe solution to reduce emissions.

Top gas recycle of blast furnace (TGRBF) with CO₂ capture can reduce the CO₂ emission from blast furnace by more than 60%. This option not only requires modification in the blast furnace but also need an assessment of BFG distribution and BFG consumers within the steel plant. TGRBF is currently in development state and not available commercially. CO₂ capture from blast furnace gas without recycle to blast furnace can be achieved without modification to the blast furnace. However, BFG after blast furnace will be mostly free from CO₂ and has 20% less volume than the BFG without CO₂ capture which contains ~23-25% CO₂. Assuming there is no loss of heat content of BFG during CO₂ capture process, BFG after CO₂ capture have 20% higher LHV. Higher LHV and lower flow rate of BFG may lead to modification of system where BFG is used as an energy source. On the other hand, for CO₂ capture as an end of pipe solution, there is no need to reassess the BFG distribution pipeline and any of the BFG consumer.

BlueScope regularly monitor and reports CO₂ emission from Port Kembla Steelworks. Thus, they have extensive data on CO₂ emission. This work has identified the 3 main points of emissions as power plant, coke oven batteries and hot blast stoves. However, BlueScope has not done any analysis on their readiness for CO₂ capture. In 2010 Australia sought to introduce a CCS readiness standard that define the following 6 requirements for Carbon Capture and Storage Readiness (CCSR)

1. “Demonstrate sufficient space and access on site and within the facility to accommodate carbon capture and compression facilities for the majority of the plant’s CO₂ emissions;
2. Identify potential areas for long term geological storage of captured CO₂ (meeting the plant’s capture needs)
3. Undertake a site-specific assessment into the technical and economic feasibility of the CO₂ capture retrofit using one or more technology choices;
4. Identify a realistic transport method to identified storage sites;
5. Demonstrate measures and approvals that deal with the collection and treatment of pollutants resulting from the capture process and provisions for increased water requirements; and
6. Estimate the likely costs of retrofitting capture, transport and storage.

One of the barriers to implement CO₂ capture in existing steel plant is availability of land area for CO₂ capture plant. As an example, for 0.5 MTPA capture unit the land estimated land requirement is 5200 m². This includes the utilities section and amine-based CO₂ capture unit. The end of pipe CO₂ capture unit for BlueScope steel has designed for 3.35 MTPA CO₂ capture. The current study can be the basis for the larger assessment of CCSR for BlueScope Port Kembla Steelworks. Any long term maintenance and modification/replacement of equipment to be done with CCSR in consideration.

Retrofitting CO₂ capture facilities may require extensive shutdown of a part of the industry combined with modification to existing technology along with huge investment. This requires well define policy framework and government incentives. It is imperative for BlueScope as the captured CO₂ cannot be utilised for revenue generation from EOR as there is no nearby oil field. Utilization of CO₂ by transformation to produce value added/platform chemicals can generate additional revenue if there is market. This report has discussed two utilization options for SMGs utilization. To achieve substantial reduction in emission intensity, it is necessary to make SMGs available for chemical conversion of SMGs. Currently only LDG is available for conversion processes. For BlueScope Port Kembla, only 6-8% CO₂ emission is due to LDG. To realize full CO₂ reduction potential of LDG utilization by ethanol production through LanzaTech biochemical process, hydrogen rich feed gas is required. Similarly, economic benefits of methanol production from SMGs depends on availability of clean hydrogen at competitive price.

If found cost effective and practical, implementation of energy efficiency measures and utilization of full amount of available LDG for ethanol or methanol production, could reduce the Scope 1 emission intensity of BlueScope Port Kembla Steelworks to 1.8 tonne/tonne of steel.

10.3 Pathway- Use of Hydrogen

Use of hydrogen in the steel making process has the potential to reduce CO₂ emission. Complete replacement of coal as a reducing material in blast furnace by hydrogen is not yet available. Under HYBRIT program this technology will be available around 2040. An alternative is being developed under COURSE50 program in Japan. Reformed COG with hydrogen content of ~80% is used in blast furnace. The target is to have industrial applications from 2030.

One of the biggest issues with the use of hydrogen will be the cost. Currently hydrogen is \$5 to \$6/kg. Bloomberg are predicting \$1/kg by 2050, which is when it will be equivalent to the current cost of natural gas. This matches well with the timeline of developing hydrogen based steel making technology as shown in Figure 13.

Partial replacement of coal by hydrogen for iron ore reduction in blast furnace has been trialled in a commercial blast furnace. In November 2019, Thyssenkrupp successfully injected hydrogen into one of 28 tuyeres, or nozzles, that otherwise supply coal into the blast furnace at the steel plant in Duisburg Germany. Following the successful trial, this technology will be further developed with potential scale ups. [101].

Part replacement of coke in the blast furnace would lead to a reduced coke requirement for the blast furnace. Current coke production rates would continue if the coke export market remained strong. Scope 1 GHG emissions would decrease, however, due to the lower internal consumption of coke.

Availability of hydrogen would improve the process efficiency for producing chemicals from SMGs.

The use of hydrogen to reduce iron ore in the blast furnaces in steel production provides a pathway for using renewable hydrogen, potentially eliminating the dependence of the industry on coal.

11. Conclusions

Steel making is an energy intensive process. Coal is used in steel making for the reduction of iron ore and providing energy. The essential role of coal in steel making makes emissions from steel plant difficult to abate. The global average emission is 1.85 tonne/tonne of crude steel and the average energy intensity is 21 GJ/tonne of crude steel. More than 70% of the global steel production is produced by BF-BOF process in integrated steel plants. Coal will continue to be used in steel making in the mid-term future, as the technologies to completely replace coal are at a nascent stage of development and not expected to be available until around 2040.

Low emission steel making through EAF process is limited by availability of recyclable steel scrap and quality of steel produced by the process.

The majority of carbon contained in the coal is transferred to the by-product fuel gases i.e. BFG, COG and LDG, with the majority of the remainder in hydrocarbon by-products e.g. coke, tar, and BTX. All the gaseous fuels are used as a source of energy at various processes within the integrated steel plant where all the carbon of these gases is emitted as CO₂.

Major steel producers, including BlueScope, have been very proactive and worked on energy efficiency initiatives. However, all the possible energy saving measures should be explored for their suitability.

Various global programs for emission reduction have identified over 100 new technologies to reduce emissions. Only a few can be implemented to a steel plant. Implementation of these technologies depends on the process, raw material and geographical location of the steel industry.

Utilization of CO and CO₂ in BFG, COG and LDG for producing valuable chemicals using chemical (Thyssen Krupp) and bio chemical (LanzaTech) processes has been explored in this study. Under current operating conditions of steel making at BlueScope, because of limited availability of COG and non-availability of clean hydrogen, the chemical route of producing methanol/urea is not economically viable. The LanzaTech process has shown favourable LCA and economic benefits for European and Chinese steel plant. The preliminary assessment of this process is promising for BlueScope, but a detailed evaluation both in LCA and cost analysis is required.

The study has also investigated CCS as an option the Port Kembla Steelworks. A review identified that individual stacks at the coke ovens, blast furnace stoves and the power plant boilers are the major points of CO₂ emissions, and accounted for approximately 65-70% of the total CO₂ emissions. Re-

direction of the flue gases from those locations to a central CO₂ capture facility would be required. Carbon capture as described would reduce the CO₂ emissions from the Port Kembla Steelworks by 45%. As there is no CO₂ storage or EOR site in the proximity of Port Kembla, a study of transport to the nearest suitable locations and storage at those locations was conducted.

The total cost of CO₂ capture and transport is A\$ 160-175 per tonne of CO₂ avoided. Within the prevailing economic and policy scenario this cost is likely to be prohibitive. The economics of CCS may be improved through shared CO₂ transport infrastructure i.e. involving multiple CO₂ “producers” in the development and funding of the necessary facilities.

All CO₂ emission reduction options require large capital investment and operating costs that will result in a significant rise in steel costs as steel is a globally traded commodity with strong competition. A rise in steel prices may make production of steel in Australia uncompetitive. There is a need to make a balance between emissions and competitiveness of steel making that can be achieved by government policy incentives.

12. Recommendations

As a result of the investigations and assessments carried out during this project, the following recommendations are made:

- BlueScope should continue their involvement in the World Steel Step-Up program to identify and implement greenhouse gas reduction initiatives.
- CCU options should be further explored, particularly considered the potential benefits of using green hydrogen to improve the carbon conversion efficiency of possible processes. Detailed feasibility works need to be undertaken to ascertain the viability of potentially suitable options.
- BlueScope should continue to investigate the feasibility of using biochar to lower greenhouse gas emissions
- Explore what benefits and incentives BlueScope can receive within the policy framework for reducing its emission. This may include benefits from classifying products of LanzaTech process as bio products (bio ethanol), and incentives such as allowing the consumption of renewal energy sources, such as biomass, for the production of biochar without carbon penalties. CO2CRC has been regularly contributing opinion making and framing of government emission policies that could help BlueScope.
- BlueScope should explore sourcing of clean and green power that can not only reduce its scope 2 emissions but can be used to produce hydrogen. Availability of hydrogen can boost the efficiency and benefits of utilization processes resulting in lower life cycle emissions and higher economic benefits. Securing the supply of hydrogen will also help in using hydrogen as a reducing agent in steel making when the technology is available.
- CCS/CCUS alone is not providing any tangible economic benefits in absence of carbon policy. Therefore, governments should support the development and deployment of CCS/CCUS as a part of low carbon initiatives. This includes supporting the low carbon products from utilization and development of their market.
- Identification of the most suitable technologies should be the priority. This may involve a few pre-feasibility and feasibility studies. Marginal Abatement Cost (MAC) curves that order emission measures on a simple economic metric (\$/tCO₂) to be developed for initial framing and identification of options.

Appendix A

Scoping economic evaluation of Port Kembla CO₂ transport and storage options

G.A. Fimbres Weihs, M. Ho, D.E. Wiley

The University of Sydney, School of Chemical and Biomolecular Engineering, NSW 2006
AUSTRALIA

1. Abstract

The main source of CO₂ emissions in an integrated steel manufacturing plant comes from the necessity to use a carbon source, often coal, in the steel making process. Among the pathways for reducing CO₂ emissions is the application of carbon capture, transport and storage (CCS) technologies. This study under sub-contract from CO₂CRC Limited (a world-leading CCUS R&D organisation in Australia) undertakes a scoping-level evaluation of the economic viability of transport and storage location options for CO₂ captured from an iron and steel plant located in Port Kembla, NSW, situated on the eastern coast of Australia. Both pipeline and ship transport of CO₂ are considered, as well as two injection locations: the Darling Basin in NSW and the Gippsland Basin in the state of Victoria, Australia. The analysis provides estimates of the cost of CO₂ transport and storage for four specific transport and storage options in south-east Australia, including the cost of pipelines/shipping, boosters, wells, other facilities, monitoring, on-costs and energy costs. The cases modelled focus on either a single CO₂ source (emissions from Port Kembla) to a single pipeline or shipping port, or on the contribution by the CO₂ source from Port Kembla to a collection of CO₂ sources including the other CO₂ sources in NSW, into a pipeline network. The sensitivity of the results to several economic and design parameters, such as flow rate, cost of electricity and project lifetime, is also assessed.

Scoping level cost estimates for transport and storage of the CO₂ are lowest for the hub transport case injecting at the Gippsland basin and highest for the case involving shipping with injection in the Gippsland basin. For the single-source cases, transport via pipeline to the Darling basin is a slightly more attractive option in terms of unit costs. Although pipeline transport to both the Darling and Gippsland basins are very close in terms of transport and storage costs (less than 0.2% difference), the cost of transporting to the Darling basin is less sensitive to variations of the cost parameters explored in this study.

The lowest transport and storage costs found in this study were for the pipeline hub transport cases, which were more than 35% lower on average than for the single source cases. Furthermore, regardless of the sensitivity scenario, the hub transport cases were between two-thirds and half of the cost of the shipping case. This highlights the importance of economies of scale in CO₂ transport, which can be achieved by employing larger diameter pipelines. This leads to decreases in both the unit capital costs by allowing larger capacities of transport, as well as in operating expenses by decreasing pressure losses along the pipelines, thus requiring less energy for compression.

Although the shipping transport option presented the highest cost of the cases considered, there is still a case to be made for ship transport if the project duration is short. As ship transport is less CAPEX intensive (35% of total cost), this mode of transport becomes competitive with pipeline transport if the project duration is decreased, or if the discount rate is increased. Further, shipping also becomes more competitive for longer transport distances. For example, if the hub transport options would take several years to implement, a case could be made for utilising ship transport for a few years while the hub pipeline is constructed, and then transporting via the hub once it is available.

2. Introduction

This transport and storage study is part of a wider project to explore the pathways for reducing carbon dioxide (CO₂) emissions in steel production and utilising gaseous exhaust streams containing carbon monoxide (CO) and CO₂. The main source of CO₂ emissions in a steel manufacturing plant comes from the necessity to use a carbon source, often coal, in the steel making process. Among the pathways for reducing CO₂ emissions is the application of carbon capture, transport and storage (CCS) technologies.

3. Objectives of study

The objective of this study is to undertake a scoping evaluation of the economic viability of transport (assessing both pipeline or shipping) and storage location options for CO₂ captured from an iron and steel plant located in Port Kembla, NSW.

The scope of the work is to provide estimates of the cost for CO₂ transport and storage for four specific transport and storage options in south-east Australia. These cost estimates are considered to be at a scoping level, as a full feasibility study has not been completed. Costs considered include pipeline/shipping, boosters, wells, other facilities, monitoring, on-costs and energy costs.

4. Basis of study

The underlying technical inputs used for the scoping evaluation of the economic viability of transport (piping or shipping) and storage location options in this study are summarised in **Table A. 1**.

Table A. 1:- Underpinning technical inputs that form the basis of this economic study.

Parameter	Units	Value
Supply rate of CO ₂ for transport and storage	Mtpa	3.83
CO ₂ quality	%	98
Initial pressure	MPa	(low pressure case) 0.1 (high pressure case) 15
Initial temperature	°C	25
Injection duration	y	30

The assumptions for economic and engineering parameters match those in the methodology and datasets provided in chapters 10, 20 and 21 of the 2015 Australian Power Generation Technology (APGT) Report [102]. These are as summarised in **Table A. 2**. The only exception is the cost year, which has been updated to 2017.

Table A. 2:-Underpinning economic assumptions that form the basis of this economic study.

Parameter	Units	Value
Cost year		2017
Currency	A\$ Australian Dollars	
AUD/USD exchange rate (2017 average) [103]		0.7668
Real discount rate [102]	%	6.4
Load factor [102]	%	85
Construction period [102]	y	2
Decommissioning period [102]	y	1
Grid power cost (weighted NEM average) [102]	A\$/MWh	42.5
Grid power CO ₂ emission intensity (weighted NEM average) [102]	tCO ₂ /MWh	0.894
Cost of Cooling Water (2017 average) [104]	A\$/ML	93.30
Cost of Diesel (2017 average) [105]	A\$/kL	1,296
Diesel combustion emission intensity [106]	tCO ₂ /kL	2.71

5. Approach and Methodology

The cases modelled focus on either a single CO₂ source (the combined Port Kembla emissions) to a single pipeline or shipping port (cases 1-3), or on the contribution by the CO₂ source from Port Kembla to a collection of CO₂ sources (hub) including the CO₂ from Port Kembla into a pipeline network (case 4). These are detailed as follows:

6. Pipeline transport from Port Kembla to the Darling basin's Pondie Range Trough for storage
7. Pipeline transport from Port Kembla to the Nearshore Gippsland Basin's Barracouta Field for storage
8. Ship transport from Port Kembla to the Nearshore Gippsland Basin's Barracouta Field for storage
9. Pipeline transport from Port Kembla to a link into a multiple source CO₂ pipeline hub (from North and South NSW power stations), and onto a single-sink hub in the (a) Darling or (b) Nearshore Gippsland Basin for storage

These four cases are depicted on a map in *Figure A 1*. The pipeline routes selected represent the shortest distance following existing pipeline easements or, if none are available, existing roads. The hub connection location is selected at the closest point of the hub pipeline (from North and South NSW power stations) to Port Kembla. The hub pipeline route also follows the shortest distance from the NSW power stations to the injection location using existing pipeline easements.

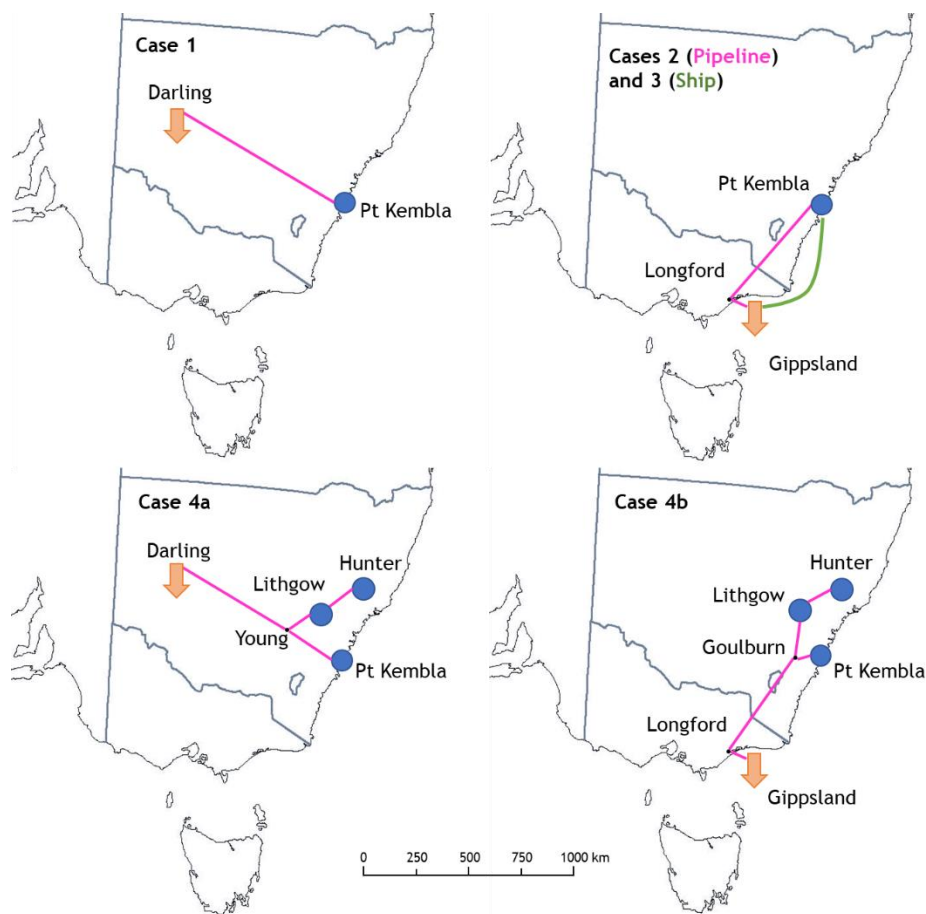

Figure A 1: Schematic representation of the cases modelled for this study

The flow rates and distances considered for each of the cases are summarised in **Table A. 3** for the single source cases, and in **Table A. 4** for the hub cases.

Table A. 3:-Flow rate and transport distance for the single source cases modelled.

Parameter	Case 1	Case 2	Case 3
Mode of transport	Pipeline	Pipeline	Ship
CO ₂ flow rate supplied (Mtpa)	3.83	3.83	3.83
Onshore distance (km)	1,010	910	-
Offshore distance (km)	-	20	650
Injection location	Darling Basin (Pondie Range)	Gippsland Basin Nearshore (Barracouta)	

Table A. 4:-Flow rate and transport distance for the hub cases modelled

Parameter	Case 4a		Case 4b	
	Pt. Kembla to Young	Young to Darling	Pt. Kembla to Goulburn	Goulburn to Gippsland
Mode of transport	Pipeline	Pipeline	Pipeline	Pipeline
CO ₂ flow rate supplied (Mtpa)	3.83	45	3.83	45
Onshore distance (km)	330	680	150	760
Offshore distance (km)	-	-	-	20
Injection location	Darling Basin (Pondie Range)		Gippsland Basin Nearshore (Barracouta)	

The parameters for the injection locations are summarised in **Table A. 5**.

Table A. 5:- Injection location parameters [102].

Parameter	Darling Basin (Pondie Range Trough)	Gippsland Basin Nearshore (Barracouta Field)
Areal extent (km ²)	1,300	200
Injection depth (m)	1,640	1,350
Formation thickness (m)	115	250
Permeability (mD)	350	1,000
Porosity (%)	11.5	25.0
Water depth (m)	0.0	46.0
Fracture pressure gradient (MPa/km)	24.5	20.8
Formation temperature (°C)	80.0	61.5
Formation pressure (MPa)	16.4	13.5

10. Cost model

Pipeline and ship transport costs for CO₂ are estimated using the Integrated Carbon Capture and Storage Economics Model (ICCSEM) [107] co-developed for the CO2CRC by the University of New South Wales, and now also University of Sydney, researchers. ICCSEM performs simple mass and energy balance as well as shortcut calculations to estimate process equipment sizes. The model accounts for economic factors such as discount rate, CAPEX phasing and project lifetime. The capital costs (CAPEX) are equipment costs incurred at the beginning of the project, whereas operating costs (OPEX) are incurred on a regular basis during the time of transport and injection. In addition, decommissioning costs are incurred at the end of the project (after injection has finalised) and

include the costs of disposing of the equipment in an environmentally safe manner and may include costs for site remediation [102]. As mentioned in *Table A. 2*, CAPEX is phased over 2 years, transport and injection occur over 30 years, decommissioning occurs over 1 year after injection has finalised, and the cost calculations are undertaken in real 2017 Australian Dollar terms. Although this study was prepared in 2019, each full year's cost indices are not made available until after the first quarter of the following year. In addition, some cost indices employed in the methodology used in this work have been discontinued since 2017, and further updates would require the development of proxy indices, which may reduce the accuracy of the estimates. Hence, 2017 was selected as the cost year, as this also facilitates comparison with the cost data reported in the APGT Report. Further details of the calculations carried out in ICCSEM can be found elsewhere [107].

11. Pipeline transport considerations

For the pipeline transport options, CAPEX includes the costs related to pipeline construction, pipelay and compression equipment. Pipeline OPEX only includes electricity, labour and maintenance costs. Electricity for compression (all cases) and liquefaction (shipping case) is assumed to be obtained from the grid at the weighted NEM average cost presented in *Table A. 2*.

12. Shipping transport considerations

For shipping costs, CAPEX includes the cost of the ship as well as the costs related to the acquisition and installation of compression and liquefaction operations. The OPEX for shipping is comprised of electricity, diesel, harbour, labour and maintenance costs.

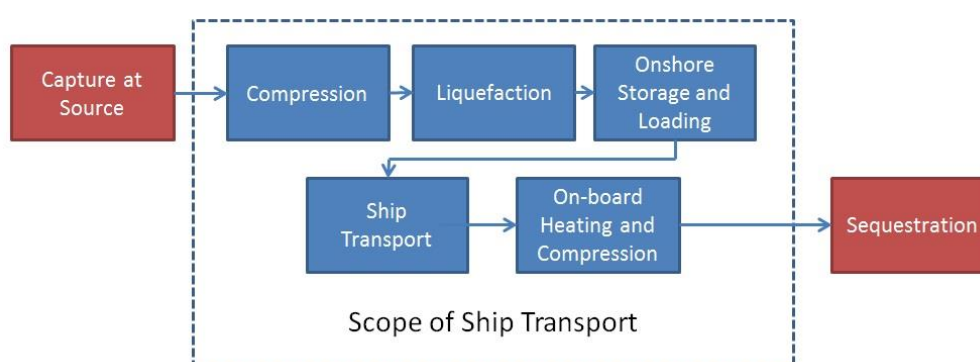

Figure A 2: Scope of ship transport

As depicted in *Figure A 2*, ship transport is assumed to consist of five key steps: compression, liquefaction, onshore storage and ship loading, transport by ship and unloading of the ship. The shipping cost methodology accounts for the cost of compression and liquefaction, as well as the cost of recompression of the transported fluid on board the ship. The CO₂ ship transport model is based on cost data from the literature and on local costs such as harbour fees and fuel where appropriate. The facilities for unloading the ship are assumed to be on the injection platform, and their cost are considered as part of the injection costs. The ship size is assumed to be equal to the amount of CO₂ emitted in a single day, following the work of Chiyoda [106]. This allows the model to be used to determine the cost for transport without the need to optimise the ship size. Further, it has been assumed that the time required to load a ship is 8 hours, and unloading time is 24 hours.

13. CO₂ losses and additional emissions

CO₂ emissions are associated with the production of electricity used for compression (for both pipeline and shipping) and liquefaction (for shipping), due to the combustion of fossil fuels by some generators in the NEM, and this is accounted by the emission intensity of the grid, as presented in *Table A. 2*. For

ship transport, CO₂ is also emitted from the combustion of diesel to drive the ship and the on-board compressor. The emission intensity of diesel combustion is also reported in **Table A. 2**. Furthermore, not all the CO₂ supplied and loaded onto the ship is delivered at the injection location due to boil-off. This is an inevitable loss due to the heat lost through the insulation of the storage vessels, and is estimated to be 0.2% per day [108]. All these CO₂ emissions are considered when determining the amount of CO₂ avoided by transport and injection.

Cost estimates obtained from the model are presented in this report in terms of the unit transport and storage cost (C_{ts}), that is, per tonne of CO₂ supplied. This unit cost is calculated as:

$$C_{ts} = \frac{CX + OX + DX}{S_{CO_2}} \quad (1)$$

where CX , OX and DX are the present values (PV) of the CAPEX, OPEX and decommissioning expenses, respectively, and S_{CO_2} is the PV of the CO₂ supplied. In addition, and for comparison purposes, the cost estimates are also reported per tonne of CO₂ delivered (D_{CO_2}) and avoided (A_{CO_2}) which are defined as:

$$D_{CO_2} = S_{CO_2} - G_{boil} \quad (2)$$

$$A_{CO_2} = S_{CO_2} - G_{boil} - G_{comb} \quad (3)$$

where G_{boil} is the PV of CO₂ emissions due to boil-off (only applicable to the shipping cases), and G_{comb} is the PV of CO₂ emissions due to combustion (for electricity generation and diesel engine drivers).

Finally, for the hub cases (4a and 4b) the unit transport cost reported is the sum of the unit transport cost for the segment from Port Kembla to the junction with the hub pipeline (Young for case 4a and Goulburn for case 4b), plus the unit transport cost for the segment from the junction to the injection location. This can be summarised by the following equation:

$$C_{ts} = \frac{CX_{PK-J} + OX_{PK-J} + DX_{PK-J}}{S_{CO_2,PK}} + \frac{CX_{J-I} + OX_{J-I} + DX_{J-I}}{S_{CO_2,tot}} \quad (4)$$

where the subscript PK-J represents the costs related to the transport segment between Port Kembla and the hub junction location, the subscript J-I represents the costs related to the transport segment between the hub junction and the injection location, $S_{CO_2,PK}$ represents the PV of the CO₂ supplied by Port Kembla, and $S_{CO_2,tot}$ represents the PV of the total CO₂ injected for the hub case.

14. Sensitivity Analysis

In order to account for the uncertainty in the assumptions, and to assess the effect of variations in several of the economic and design parameters, a sensitivity analysis is carried out. The parameters varied in this analysis are the CO₂ flow rate, the grid power cost (cost of electricity, COE), the cost of diesel, the transport distance, the discount rate and the project lifetime. Each of these parameters is in turn increased and decreased from its baseline value, and the effect on the unit transport and storage cost is evaluated.

For the flow rate and cost of diesel, $\pm 30\%$ scenarios are considered. The flow rate of CO₂ can vary due to steel production variations, and the variability of the cost of diesel is based on historical data [105]. Transport distance cannot be reduced by 30%, as this would yield distances shorter than a straight-line distance between the CO₂ source and the injection locations; therefore, $\pm 20\%$ scenarios are considered for transport distance. The annual average grid power cost in the Australian National Energy Market has varied significantly over the past 5 years, from a low of A\$28.29/MWh in 2015, to

a high of A\$109.81/MWh in 2019 [109]; however, there is no clear trend. Therefore, three values are used for the COE, namely half, double and 4-times the baseline cost. The real discount rate is varied from 5% to 10% and the project lifetime is varied from 20 years to 40 years. The sensitivity scenarios are summarised in **Table A. 6**.

Table A. 6:-Sensitivity analysis scenarios explored

Parameter	Units	Scenarios
Supply rate of CO ₂	Mtpa	2.7 (-30%)
		5.0 (+30%)
Cost of electricity	A\$/MWh	21.25 (0.5×)
		85.00 (2.0×)
		170.00 (4.0×)
Cost of Diesel	A\$/kL	900 (-30%)
		1,700 (+30%)
Transport distance		-20%
		+20%
Real discount rate	%	5.0
		10.0
Injection duration (Project duration)	y	20
		40

15. Results

The cases with low pressure supply (0.1 MPa) assume that the CO₂ is available prior to compression. This allows an easier comparison between the ship and pipeline transport, because transport pressure for the CO₂ in the ship is only 2.4 MPa, whereas the pipelines operate at pressures in range of 8 to 15 MPa. The transport and storage costs for low pressure supply are presented in **Figure A 3**.

The data in **Figure A 3** shows that transport via ship results in the largest cost per tonne of CO₂ supplied (A\$34.75). Although shipping has the lowest capital expenditure of all the cases analysed, it also has the largest operating expenditure, which is driven by the cost of diesel and electricity. In addition, it should be noted that ship transport also incurs a small loss of the CO₂ transported due to boil-off. Expressing the cost of transport and storage in terms of the amount of CO₂ delivered, rather than supplied, raises this cost slightly to A\$34.80.

The two single-source cases have practically the same cost, regardless of the injection location (Darling or Gippsland basin), at approximately A\$31.80 per tonne supplied. Although the option using the Gippsland basin for storage results in larger injection costs due to offshore injection, these are offset by the higher compression requirements for the longer transport distance in the case injecting in the Darling basin. Nonetheless, as both these costs are lower than the shipping option, this suggests pipeline would be the preferred method of transportation.

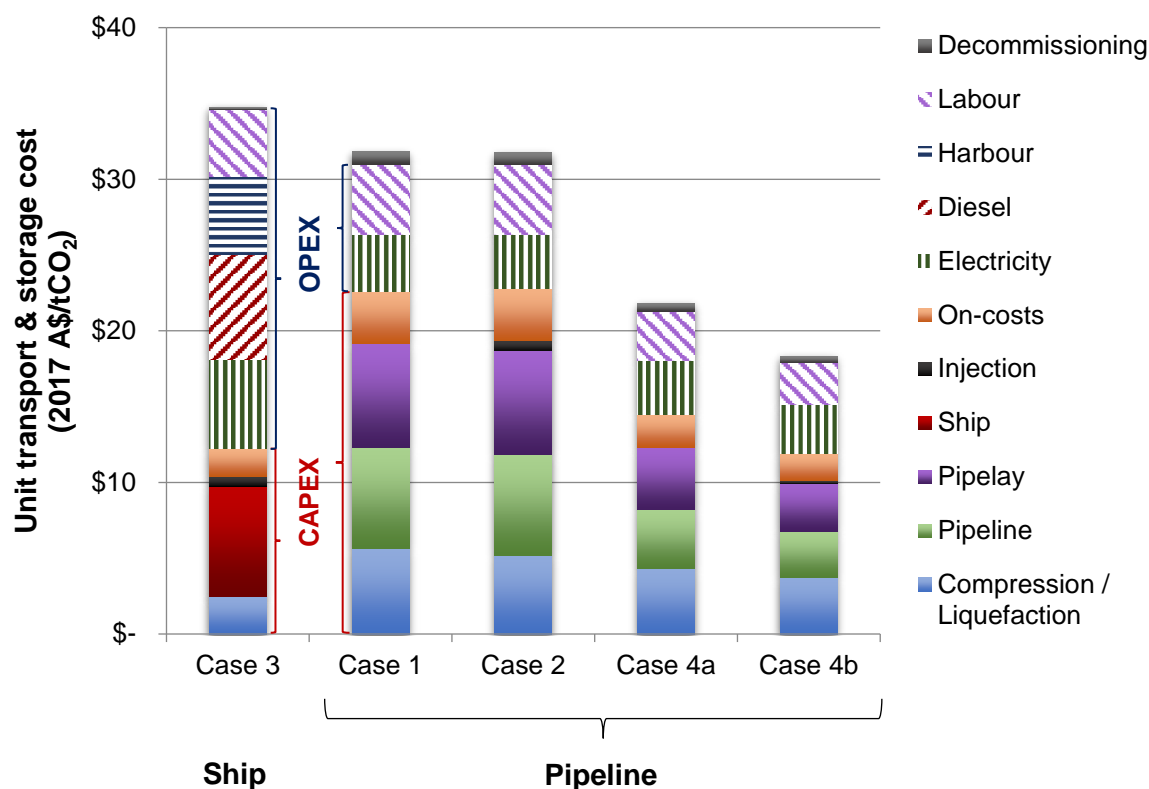

Figure A 3: Transport and storage costs per tonne of CO₂ supplied at low pressure (0.1 MPa).

It is also important to note that all the cases with offshore injection into the Gippsland basin (2, 3 and 4b) present larger injection unit costs than their onshore counterparts. The hub transport options, as expected, yield lower transport costs due to the economies of scale of using larger diameter pipelines for the combined flow rates. The case involving injecting in the Gippsland basin (case 4b) yields a slightly lower unit cost (A\$18.30) than case 4a that uses the Darling basin as storage (A\$21.80), due to the former having a shorter pipeline length before the connection to the hub. Thus, the Darling basin hub case results in larger pipeline and compression costs than the Gippsland counterpart. In general, the cost for the hub case injection in the Darling basin decreases as the junction to the hub is located closer to Port Kembla, and it would have a lower cost than injecting in the Gippsland basin if the junction was located at a distance of less than 100 km from Port Kembla. However, the cost reported here only considers the cost to the Port Kembla operator (for the CO₂ captured at Port Kembla) when the junction is located at an economically-balanced place for all network users. Placing the junction location closer to the Port Kembla source under the current pipeline network designed depicted in *Figure A 1* would mean a longer transport distance for the rest of the CO₂ transported in the hub pipeline, and thus higher costs for the other operators. As the amount of CO₂ transported from Port Kembla is smaller, placing the junction location closer to this source would likely lead to higher overall costs for the whole CO₂ transport network. However, these trends may change if different transport routes were to be considered; for example, a multi-branch network in which the branch from the Hunter source transports the CO₂ south to join the Port Kembla branch within 100 km of Port Kembla, and then joins the Lithgow branch near Young, may lead to lower overall costs. Nevertheless, such a network design would need to be checked with more detailed calculations that should also investigate other features of a large-scale hub network (e.g. topography) which fall outside the scope of this scoping study.

The case with high pressure supply (15 MPa) assumes that the CO₂ is in a supercritical state, following a compression stage after capture. The transport and storage costs for high pressure supply are presented in *Figure A 4*.

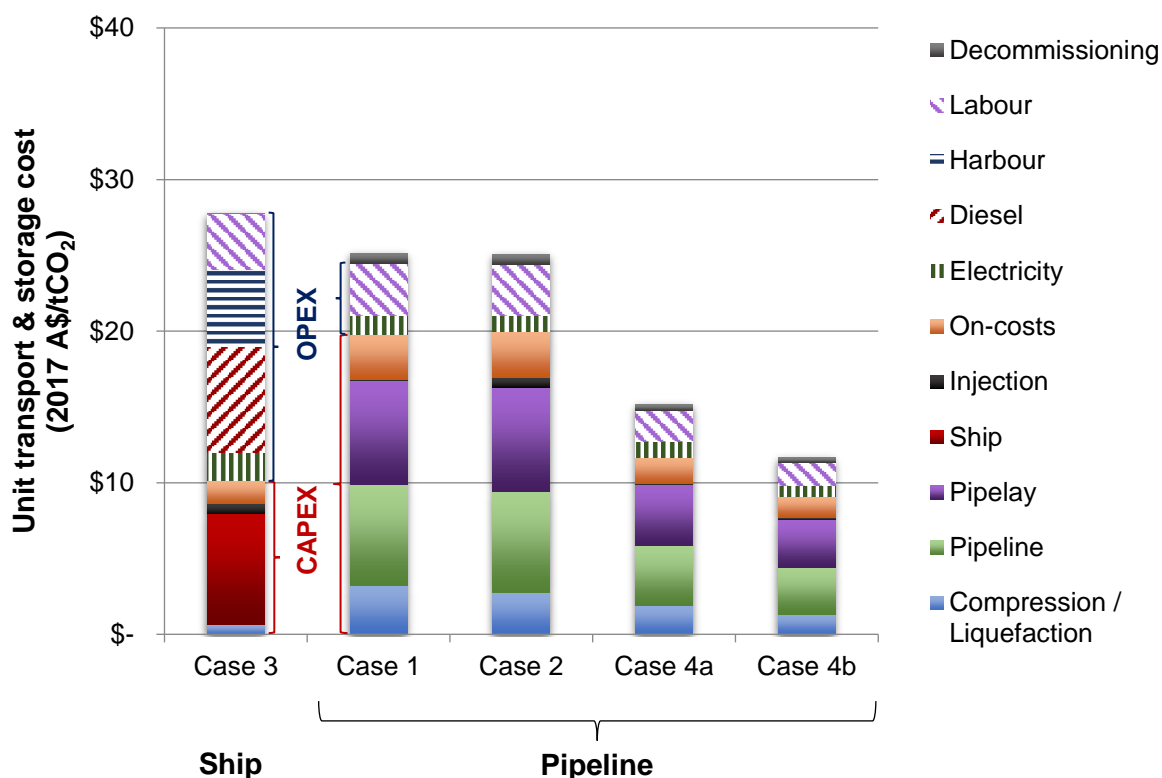

Figure A 4: Transport and storage costs per tonne of CO₂ supplied at high pressure (15 MPa).

Comparing *Figure A 3* and *Figure A 4*, the same cost trends are evident, with the shipping case being the highest cost option, the single source pipeline cases having practically the same cost, and the hub option with injection in the Gippsland basin having a lower unit cost than the hub option with storage in the Darling basin. However, the unit costs for the high-pressure supply cases are 20% to 30% lower (or A\$6.60 to A\$7 lower per tonne of CO₂ supplied), due to the cost of compression being removed.

16. Sensitivity Analysis

The transport and storage costs are compared for the low pressure supply (0.1 MPa) using the different bases for unit costing (per tonne of CO₂ supplied, delivered and avoided) in *Figure A 5*. The results show that the difference between the costs per tonne of CO₂ supplied and delivered is negligible (increasing A\$34.81/tCO₂ or less than 0.2%) for the case of shipping transport (case 3), which is the only case that presents such a difference due to boil-off. This suggests that the boil-off losses for transport from Port Kembla to the Gippsland basin can be neglected, as the one-way journey is less than 2 days, and thus too short for boil-off to be significant. On the other hand, the increase in unit cost per tonne of CO₂ avoided compared to the cost per tonne of CO₂ supplied is around 14.5% on average, and this increase is larger for the shipping and single pipeline cases than for the hub cases. This is expected, as economies of scale lead to smaller pressure losses per tonne transported as larger pipeline diameters are used. This, in turn, leads to lower energy requirements and lower CO₂ emissions due to power generation. It is also notable that the hub case with injection in the Gippsland basin (case 4b) shows a slightly smaller increase than the hub case injecting in the Darling basin (case 4a), and this is due to the shorter transport distance also leading to smaller pressure losses, and thus lower compression energy requirements.

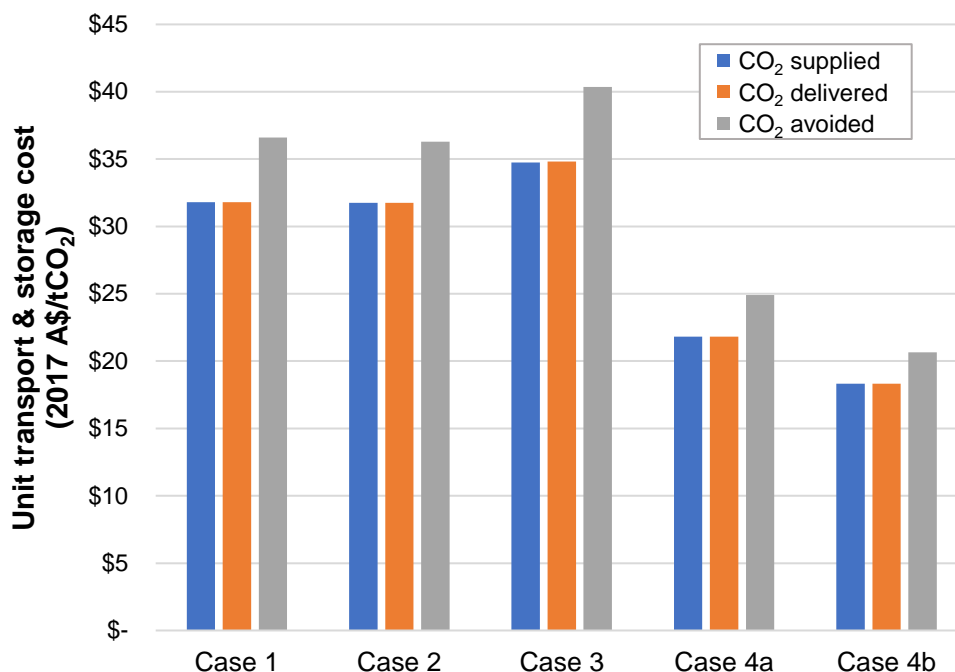

Figure A 5: Transport and storage costs at low pressure supply (0.1 MPa), expressed per tonne of CO₂ supplied, delivered and avoided

In terms of sensitivity to the different cost parameters varied for the cases with low pressure supply (0.1 MPa), *Figure A 5* shows that the unit cost of transport and storage will decrease if the transport distance, discount rate, cost of electricity or cost of diesel are decreased, or if the flow rate or project duration are increased. The largest decrease in unit costs is obtained when the transport distance is reduced by 20% or the flow rate is increased by 30%. On the other hand, the largest increase in unit costs is obtained when the cost of electricity is quadrupled, followed by the scenario where the discount rate is increased to 10%.

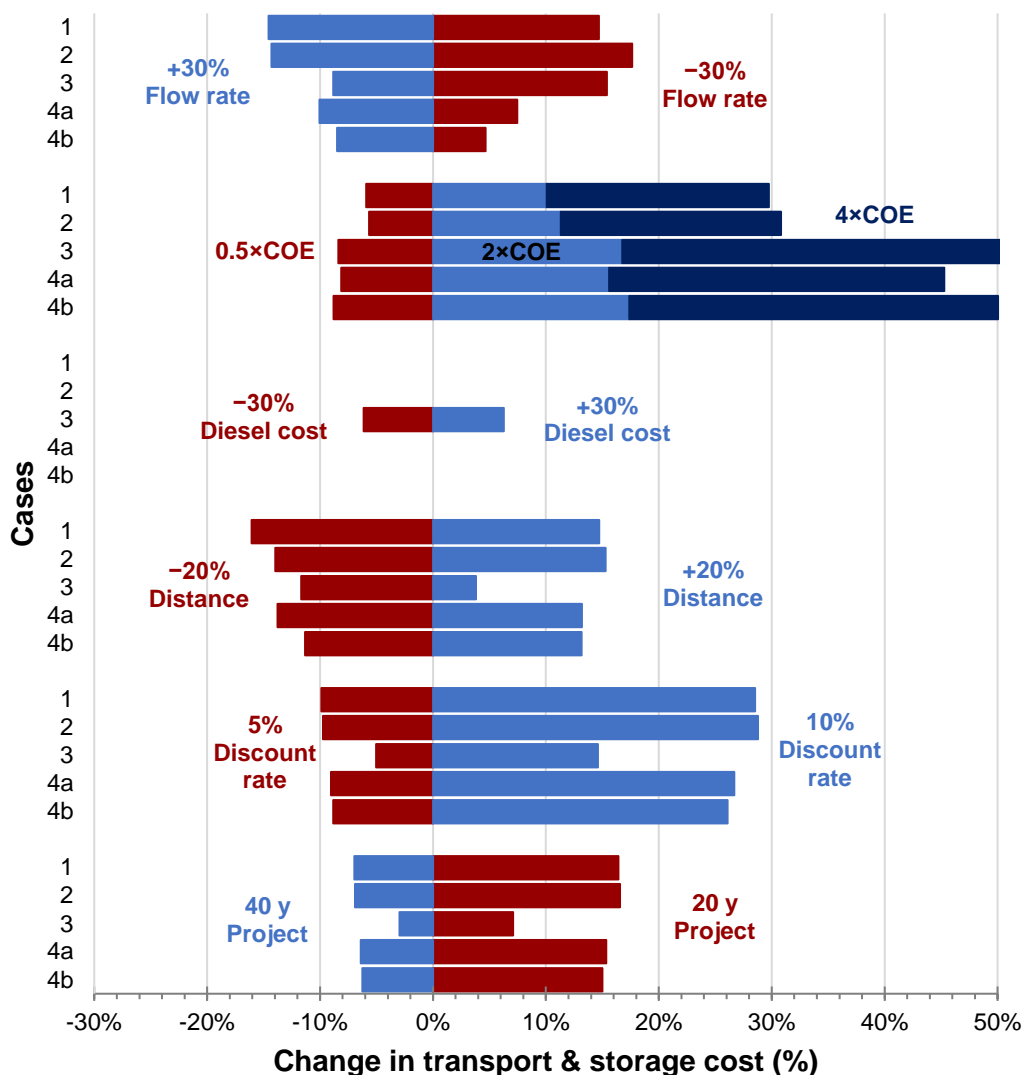

Figure A 6:-Sensitivity to parameter variations for CO2 supplied at low pressure (0.1 MPa).

Moreover, **Figure A 6** also shows that ship transport (case 3) is less sensitive to most of the variation scenarios than the single pipeline transport options (cases 1 and 2), with the notable exceptions of cost of electricity and, as expected, cost of diesel. This is because those two scenarios only affect the OPEX component of the unit transport costs, and shipping is more OPEX intensive than the pipeline transport options (as shown in **Figure A 3**, about 64% of unit costs are due to OPEX). On the other hand, the discount rate and project duration tend to affect the proportion of unit costs due to CAPEX, and the flow rate affects both components. As expected, the pipeline cases are not sensitive to the cost of diesel, as it was not assumed that this fuel is used for pipeline transport, but only electricity from the grid is relied upon.

In general, the unit costs for the hub cases (4a and 4b) are less sensitive to the variations than the single pipe cases, with the notable exception of the cost of electricity. This is because of economies of scale, as the hub cases are less CAPEX intensive per unit of CO₂ transported (66% on average) than the single pipeline cases (71% on average). Nonetheless, the hub cases are more sensitive to the cost of electricity because OPEX represents a larger proportion of the unit costs than for the single pipeline cases.

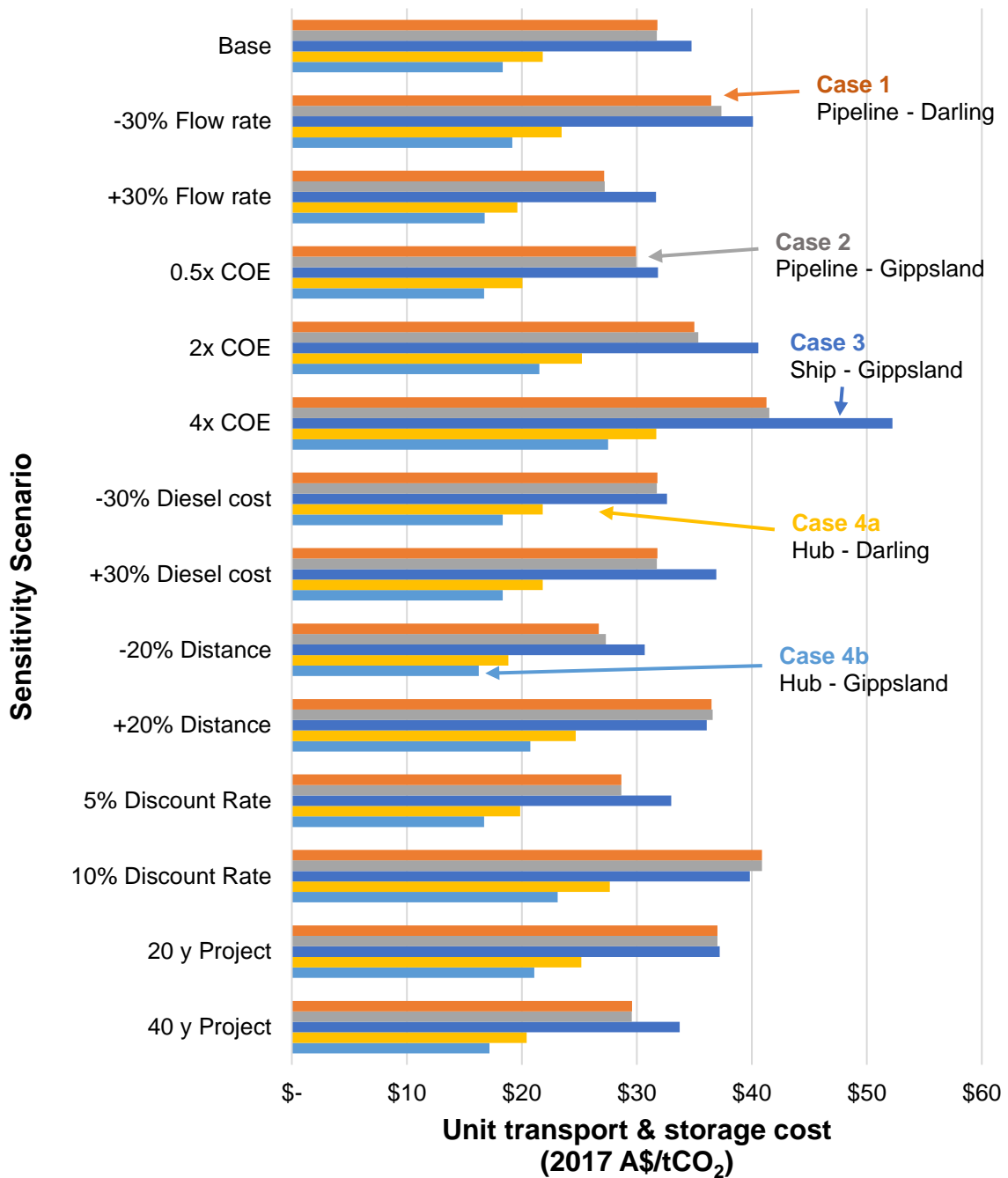

Figure A 7: Sensitivity scenario cost results per tonne of CO2 supplied at low pressure (0.1 MPa).

Figure A 7 shows the sensitivity scenario unit cost results for the cases with low pressure supply (0.1 MPa). The unit cost for transport and storage ranges from just over A\$52 per tonne of CO₂ for shipping to the Gippsland basin at 4 times the cost of electricity of the base scenario, to just over A\$16 per tonne of CO₂ for the hub case with injection in the Gippsland basin when the transport distance is 20% shorter. For the base scenario, as mentioned in the previous section, the ship transport option to the Gippsland basin (case 3) resulted in the largest transport and storage cost, followed by the single pipeline options to the Darling and Gippsland basin (cases 1 and 2, respectively) at practically the same cost, then followed by the hub transport option to the Darling

basin (case 4a), and finally the lowest cost option was the hub transport to the Gippsland basin (case 4b). As seen in *Figure A 7*, this order is maintained under most of the sensitivity scenarios, and in particular case 4a being costlier than case 4b remains true for all the scenarios considered. However, there are a few important exceptions that are worth mentioning.

Firstly, the relative ranking of cases 1 and 2 switches from case 2 having a slightly lower cost than case 1 in the base scenario, to case 1 having a slightly lower cost than case 2 for most of the sensitivity scenarios, except when there is a change in project duration or diesel cost. This is expected for the change in diesel cost, as it does not affect the pipeline cases. On the other hand, for the scenarios where the order is switched, this happens regardless of the direction of the change in the cost parameter (e.g. case 1 has lower cost than case 2 whether the flow rate is increased or decreased). This can be attributed to the combinatorial nature of the pipeline design optimisation, because only an integer number of segments can be used, and only specific nominal pipeline diameters are available (viz. both the number of segments and the pipeline diameter are discrete variables, not continuous). This means that small variations in flow rate, distance, etc. can cause the optimal diameter selected to change from one discrete value to the next in one of the cases but not the other, causing a significant change in cost of transport for one case, but only a small change in the other case. Nonetheless, the transport and storage costs for cases 1 and 2 are on average within 0.5% of each other, and never more than 2.5% apart. Even though the scenarios presenting lower flow rate and shorter transport distance show the largest difference in favour of case 1, overall it can be concluded that the cost of transport and storage via a single pipeline to the Darling and Gippsland basin are roughly the same for all the scenarios considered.

Secondly, although the ship transport option (case 3) is generally the highest cost, this is not true for the scenarios with a larger discount rate of 10%, or for a 20% longer transport distance. For the larger discount rate scenario, this is related to shipping being more OPEX intensive than pipeline transport, as a higher discount rate gives more weight to CAPEX in the present value calculation. For the longer distance scenario, case 3 becomes less costly than cases 1 and 2 because shipping is less sensitive to transport distance than pipeline transport, as it only increases a few OPEX components (diesel and labour, but not compression/liquefaction), whereas a longer distance increases both CAPEX (pipeline and pipelay) and OPEX (compression) for pipeline transport. This sensitivity result agrees with the results of Decarre et al. [110], who found that ship transport of CO₂ is more economical than onshore pipeline transport when the distance increases over about 1,100 km; the longer distance scenario with the same injection location as case 3 is case 2, with a total transport distance of 1,116 km.

In addition, for the scenarios with a shorter project duration of 20 years and for a 30% lower diesel cost, the transport and storage cost for case 3 is reduced to roughly the same value as cases 1 and 2 (within less than 3%). This is again related to the smaller proportion of CAPEX for ship transport, and the fact that pipeline transport is insensitive to diesel cost. Furthermore, a decrease in the cost of electricity also brings the cost of transport via ship closer to that via pipeline, due to reduction in liquefaction costs, which are a larger proportion of total costs for case 3 than for cases 1 and 2. Overall, it can be concluded that decreasing the cost of electricity or diesel, decreasing the project duration, and increasing the transport distance or the discount rate, can make the shipping option competitive with pipeline transport, but only the latter two scenarios can make shipping more competitive than pipeline transport for the case studied in this report.

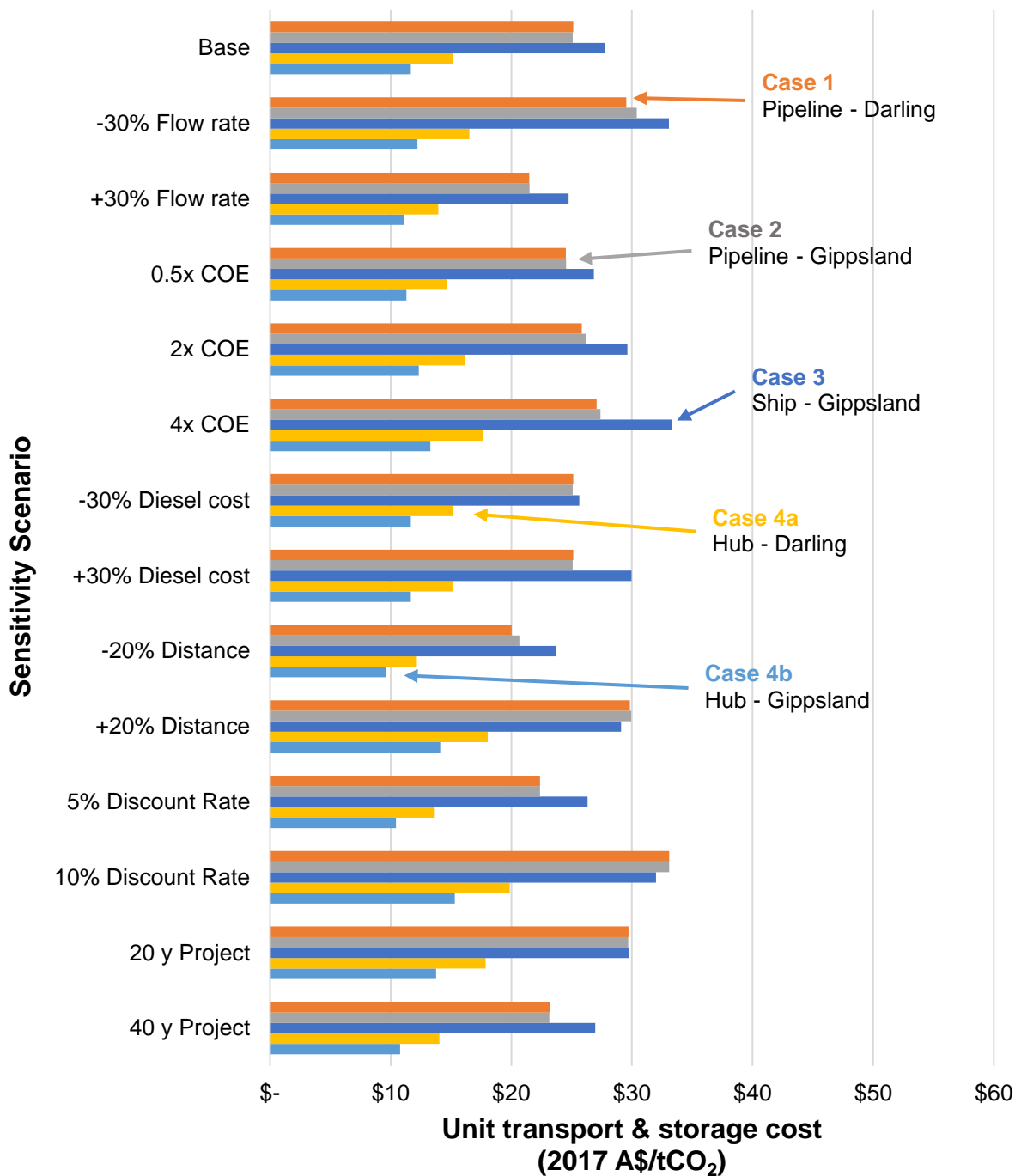

Figure A 8: Sensitivity scenario cost results per tonne of CO₂ supplied at high pressure (15 MPa).

The sensitivity results for the cases with high pressure supply (15 MPa) are presented in *Figure A 8*. All of the trends discussed from the low pressure supply cases in *Figure A 7* are also present in the high pressure supply cases. That is to say, the unit costs for cases 1 and 2 are roughly the same regardless of the sensitivity scenario, and shipping becomes more competitive if flow rate, project duration or diesel costs are decreased, or if the discount rate or transport distance are increased. This is to be expected, given that within each scenario the cost of increasing the supply pressure from 0.1 to 15

MPa is the same, and therefore adds the same cost component to all the cases considered, without altering their relative ranking.

17. Conclusions

This study undertakes a scoping-level evaluation of the economic viability of transport of CO₂ captured from an iron and steel plant located at Port Kembla, NSW. Two storage location options are considered, as well as two means of transport (pipeline and shipping). In addition, a pipeline hub transport option is considered, where the CO₂ from the Port Kembla plant is transported together with a larger CO₂ flow rate captured from NSW power stations.

The scoping estimates for costs of transport and storage of the CO₂ range between A\$34.75 per tonne of CO₂ supplied for the case involving shipping with injection in the Gippsland basin, to A\$18.33 per tonne of CO₂ supplied for the hub transport case injecting at the Gippsland basin. These costs have very good agreement with those in the Australian Power Generation Report [102], which gives transport and storage costs for a single source in South NSW of approximately A\$34 per tonne for injecting in the Darling basin and A\$36 per tonne for injection in the Gippsland basin. Moreover, they report around A\$17 to A\$19 per tonne for multiple sources in South NSW injecting in the Gippsland basin. Nevertheless, it should be noted that the value of this scoping-level study is in the relative costs of the different scenarios rather than in the actual comparative costs, which are subject to uncertainties that may have a significant impact on the final results (up to ±30%). It is for this latter reason that a sensitivity analysis was carried out, in order to ascertain how major changes to the economic parameter assumptions would affect the costs presented here.

For the single-source (non-hub) cases, transport via ship to the Gippsland basin (case 3) would result in the highest unit cost. However, as ship transport is less CAPEX intensive (35% of total cost), this mode of transport becomes competitive with pipeline transport if the project duration is decreased, or if the discount rate is increased. Further, shipping also becomes more competitive for longer transport distances. Nevertheless, fugitive CO₂ emissions due to boil-off and CO₂ emissions due to fuel combustion should also be taken into account if the shipping option is to be further considered.

For the single-source cases, transport via pipeline to the Darling basin (case 1) is a slightly more attractive option in terms of unit costs. Although both pipeline transport to the Darling and Gippsland basin are very close in terms of transport and storage costs (about A\$31.80 per tonne supplied, with less than 0.2% difference between the two cases), the cost of transporting to the Darling basin is less sensitive to variations of the cost parameters explored in this study. This is because injection in the Darling basin does not include an offshore transport or injection component. Hence, this work provides evidence of the possibility for NSW to manage their CO₂ emissions within their state borders and suggests that continuing efforts to characterise the Darling basin are well justified. However, injection in the Darling basin involves a slightly (about 10%) longer transport distance, which implies more pressure losses and, thus, higher energy requirements which may lead to higher CO₂ emissions due to electricity generation. On the other hand, the recent trends for transitioning to renewable energy in the NEM suggests that the emission intensity of electricity generation is expected to decrease over time, leading to a lower sensitivity to energy usage in terms of the cost per tonne of CO₂ avoided.

When hub cases are considered, the case of injecting in the Gippsland basin was generally less costly. This is strongly related to the location of the junction between the Port Kembla pipeline and the hub pipeline. A scoping estimate indicated that as the junction location is placed closer to Port Kembla, the case with injection in the Darling basin is decreased, and it would have a lower cost if the junction was less than 100 km from Port Kembla. However, decreasing the cost for Port Kembla

using the pipeline network design considered for this study would likely increase the cost for transporting the CO₂ from the other sources. Nevertheless, the overall cost would depend on the specific transport routes chosen, and other network designs with multiple branches may lead to lower overall costs. This highlights how a holistic, cross-industry, effort for CCS in NSW would significantly reduce the cost of CO₂ emission abatement. A more detailed network design study that considers branching, pipeline routing and topography, among other features of a large-scale hub network, would provide more insights into an optimal transport and storage strategy.

Another factor that should be considered in future feasibility analyses is the availability of pipeline easements for the proposed pipeline transport routes. Although this study did not make those considerations, all the pipeline routes considered have significant overlap with existing natural gas pipelines. More detailed studies should also consider the topography and populated areas when determining specific pipeline routes.

The lowest transport and storage costs found in this study were for the pipeline hub transport cases, which were more than 35% lower on average. Furthermore, regardless of the sensitivity scenario, the hub transport cases were between two-thirds and half of the cost of the shipping case. This highlights the importance of economies of scale in CO₂ transport, which can be achieved by employing larger diameter pipelines. This leads to decreases in both the unit capital costs by allowing larger capacities of transport, as well as in operating expenses by decreasing pressure losses along the pipelines, thus requiring less energy for compression. Although the shipping transport option presented the highest cost of the cases considered, there is still a case to be made for ship transport if the project duration is short. For example, if the hub transport options would take several years to implement, a case could be made for utilising ship transport for a few years while the hub pipeline is constructed, and then transporting via the hub once it is available.

References

1. The World Bank Group Oil, G., Mining and Chemicals Department, *The Outlook for Metals Markets Prepared for G20 Deputies Meeting Sydney 2006*, in 2006, The World Bank: Washington.
2. Association, W.S., *Global crude steel output increases by 4.6% in 2018*. 2019, World Steel Association: <https://www.worldsteel.org/media-centre/press-releases/2019/Global-crude-steel-output-increases-by-4.6--in-2018.html>.
3. World Steel Association, *FACT SHEET: Energy use in the steel industry*. 2018.
4. World Steel Association. *STEEL'S CONTRIBUTION TO A LOW CARBON FUTURE AND CLIMATE RESILIENT SOCIETIES*. 2019 [cited March 2019].
5. BlueScope Steel. *About Us*. [cited 2020 March]; Available from: <https://www.bluescope.com/about-us/our-business/australian-steel-products/>.
6. *National Inventory by Economic Sector 2017- Australia's National Greenhouse Accounts 2019*, Australian Government, Department of Energy and Environment.
7. World Steel Association, *WORLD STEEL IN FIGURES 2018*. 2018.
8. Horvath, L. *Energy Use in Steel Industry*. in *IEAGHG/IETS Iron & Steel Industry CCUS and Process Integration Workshop*. 2013. Tokyo, Japan.
9. *Private communication between BlueScope Steel CO2CRC Limited*. 2019.
10. NSW Govt., D.o.P.E., Div. of Resources & Geoscience, *CO2CRC Limited - Reduction of Greenhouse Gas Emissions in Steel Production*, in *Funding Deed - Coal Innovation NSW Fund*. 2019, SW Govt., Dept. of Planning & Environm., .
11. Ali Hasanbeigi and L. Price, *Emerging Energy-efficiency and Carbon Dioxide Emissions-reduction Technologies for the Iron and Steel Industry*. 2013, ERNEST ORLANDO LAWRENCE BERKELEY NATIONAL LABORATORY.

12. *Iron and Steelmaking Processes: Greenhouse Emissions, Control, and Reduction*, ed. P. Cavaliere. 2016: Springer International Publishing Switzerland
13. Russell, C.S. and W.J. Vaughn, *Steel Production : Processes, Products, and Residuals*. 2011, Washington, UNITED KINGDOM: Earthscan LLC.
14. World Steel Association, *SUSTAINABLE STEEL: Policy and indicators 2016*. 2016.
15. IEA. *Tracking Industry- Iron and Steel*. 2020 [cited 2020; Available from: <https://www.iea.org/reports/tracking-industry/iron-and-steel>].
16. *BP Statistical Review of World Energy* June 2018, BP.
17. IEA, *Material efficiency in clean energy transitions*. 2019: IEA Paris.
18. World Resources Institute, *The Greenhouse Gas Protocol: A Corporate Accounting and Reporting Standard REVISED EDITION*. World Resources Institute: Washington DC USA.
19. Peter Levi, *IEA Technology Roadmap- The global iron and steel sector*, in *OECD Steel Committee*. 2019: Paris.
20. International Energy Agency, *Energy Technology Perspectives 2015*. 2015, IEA: Paris, France.
21. Simon Dietz, B.R., Jeremy Sung, *CARBON PERFORMANCE ASSESSMENT OF STEEL MAKERS: NOTE ON METHODOLOGY- Version 1.2*. 2017, Transition Pathway Initiative
22. IEA, *Energy Technology Perspectives 2016 Towards Sustainable Urban Energy Systems*. 2016.
23. World Steel Association. *Our Indicators*. [cited 2019 August]; Available from: <https://www.worldsteel.org/steel-by-topic/sustainability/sustainability-indicators.html>.
24. Sharif Jahanshahi, M.S., Alex Deev and John Mathieson. *Biomass: Providing a low capital route to low net CO2 emissions*. in *Iron and Steel Industry CCUS & Process Integration Workshop*. 2013. Tokyo Japan: IEAGHG.
25. John G Mathieson, H.R., Michael Somerville, Phillip Ridgeway and Sharif Jahanshahi. *Use of Biomass in the Iron and Steel Industry – An Australian Perspective*. in *International Conference on Energy Efficiency and CO2 Reduction in the Steel Industry*. 2011. Düsseldorf.
26. Mandova, H., et al., *Global assessment of biomass suitability for ironmaking – Opportunities for co-location of sustainable biomass, iron and steel production and supportive policies*. *Sustainable Energy Technologies and Assessments*, 2018. **27**: p. 23-39.
27. CSIRO Australia. *Global vision for 'green steel'*. [cited 2019 March]; Available from: <https://www.csiro.au/en/Research/MRF/Areas/Resourceful-magazine/Issue-07/green-steel>.
28. World Cement. *Dry Slag Granulation technology to be tested on industrial scale in China*. [cited 2019 March]; Available from: <https://www.worldcement.com/asia-pacific-rim/16032015/dsg-technology-to-be-trialled-on-industrial-scale-526/>.
29. Science, A.A.o. *Turning old wheels into new steel*. 2020 [cited 2020 March]; Available from: <https://www.science.org.au/curious/technology-future/turning-old-wheels-new-steel#:~:text=Take%20an%20ordinary%20old%20rubber,landfills%20all%20around%20the%20world.&text=The%20shredded%20rubber%20polymer%20is,iron%20needed%20for%20the%20steel>.
30. Australian Steel Institute. *Steel Making: Now and into Future*. [cited 2020 March]; Available from: <https://www.steel.org.au/focus-areas/environmental-sustainability/responsible-steelmaking/improving-performance/>.
31. Mittal, A. *Steelanol recycles carbon into sustainable, advanced bio-ethanol*. [cited March 2019]; Available from: <http://www.steelanol.eu/en>.
32. SSAB. *HYBRIT - Toward fossil-free steel*. [cited 2019 March]; Available from: <https://www.ssab.com/company/sustainability/sustainable-operations/hybrit>.
33. Thyssenkrupp AG. *The Carbon2Chem® project*. [cited 2019 March]; Available from: <https://www.thyssenkrupp.com/en/carbon2chem/>.
34. *The stepwise project*. [cited 2020 March]; Available from: <https://www.stepwise.eu/>.
35. M. Abdul Quader, S., Dawa IS.Z, Nukman Y,, *Present needs, recent progress and future trends of energy-efficient Ultra-*

- LowCarbonDioxide(CO2) Steelmaking(ULCOS)program*. Renewable and Sustainable Energy Reviews, 2016. **55**: p. 537-549.
36. STEI, J.V.d., *Development of ULCOS Blast Furnace*, in IEAGHG. *IELTS Iron and Steel Industry CCUS and Process Integration Workshop Tokyo, Japan*. 2013.
 37. IEAGHG, *Overview to the Current State and Development of CO₂ Capture Technologies in the Ironmaking Process*. 2013, IEAGHG.
 38. Keys, A., M. van Hout, and B. Daniëls, *Decarbonisation options for the Dutch steel industry*. 2019 PBL Netherlands Environmental Assessment Agency; : The Hague.
 39. Sweden, S. *First in fossil-free steel*. [cited 2020 March]; Available from: <https://www.ssab.com/company/sustainability/sustainable-operations/hybrit>.
 40. Toshiba Corporation, *Applying Carbon Capture and Storage to a Chinese Steel Plant*. 2015, Toshiba Corporation.
 41. Remus, R., et al., *Best Available Techniques (BAT) Reference Document for Iron and Steel Production*. 2013, European Commission Joint Research Centre.
 42. IEAGHG, *Greenhouse Gas Emissions from Industrial Sources - III Iron and Steel Production*. 2000, IEAGHG.
 43. IEAGHG, *Iron and Steel CCS Study (Techno-Economics Integrated Steel Mill)*. 2013, IEAGHG.
 44. Pfaff I, O. and K.A. J, *Optimised integration of post-combustion CO₂ capture process in greenfield power plants*. Energy, 2010. **35**(10).
 45. Birat, J., *Steel Sectoral Report*, in *Global Technology Roadmap for CCS in Industry*. 2010, United Nations Industrial Development Organization.
 46. ERIA, *Improving Emission Regulation for Coal-fired Power Plants in ASEAN*. 2016, Economic Research Institute for ASEAN and East Asia.
 47. Reynolds, A.J., et al., *Chemical Characterization of MEA Degradation in PCC pilot plants operating in Australia*. Energy Procedia, 2013. **37**: p. 877-882.
 48. Rhee, C.H., et al., *Process analysis for ammonia-based CO₂ capture in ironmaking industry*. Energy Procedia, 2011. **4**: p. 1486-1493.
 49. Birat, J.P., *Carbon dioxide (CO₂) capture and storage technology in the iron and steel industry*. In: *Developments and innovation in carbon dioxide (CO₂) capture and storage technology. Volume 1: carbon dioxide (CO₂) capture, transport and industrial applications*. 2010: Woodhead Publishing
 50. (IEAGHG), I.E.A.f.G.H.G.I., *Iron and steel CCS study (techno-economics integrated steel mill)*. 2013, IEAGHG: Cheltenham, Glos, UK.
 51. Jai Kant Pandit, T.H., Claire Anderson,, *Repowering and Auxiliary Heating Options for Existing Coal Fired Power Plants with Post Combustion CO₂ capture*. Report # RPT 14-4970. 2014, CO2CRC: Melbourne.
 52. POWER, G. *6F Power Plants*. GE POWER.com , GEA32934 (11/2017), 2020.
 53. (NETL), N.E.T.L., *Capital Cost Scaling Methodology, in QUALITY GUIDELINES FOR ENERGY SYSTEM STUDIES*. . 2013.
 54. GTW, G.T.W., *GTW Handbook*. 2006.
 55. NETL, *Cost and Performance Baseline for Fossil Energy Plants Volume 1: Bituminous Coal and Natural Gas to Electricity -Revision 2*. 2010.
 56. IEAGHG, *Cost of CO₂ Capture in the Industrial Sector: Cement and Iron and Steel Industries-IEAGHG Technical Review 2018-TR03*. 2018.
 57. Lawrence Irlam, *GLOBAL COSTS OF CARBON CAPTURE AND STORAGE - A Report by GCCSI*. 2017, Global CCS Institute.
 58. IEA, *Transforming Industry through CCUS*. 2019, INTERNATIONAL ENERGY AGENCY.
 59. Fatima Maria Ahmad, *CO₂ Utilization: A Look Ahead*. Carbon Capture Journal, 2016.
 60. Álvaro A. Ramírez-Santos, Christophe Castel, and E. Favre, *A review of gas separation technologies within emission reduction programs in the iron and steel sector: Current application and development perspectives*. Separation and Purification Technology, 2018. **194**: p. 425-442.

61. Mercedes, M.-V.M., *Industrial Utilization of Carbon Dioxide*, in *Developments and Innovation in Carbon Dioxide (CO₂) Capture and Storage Technology, Volume 2 - Carbon Dioxide (CO₂) Storage and Utilisation*. 2011, Woodhead Publishing.
62. Rafiee, A., K.R. Khalilpour, and D.P. Milani, Mehdi, *Trends in CO₂ conversion and utilization: A review from process systems perspectives*. *Journal of Environmental Chemical Engineering*, 2018. **6**: p. 5771-5794.
63. Koytsoumpa, E.I., C. Bergins, and E. Kakaras, *The CO₂ economy: Review of CO₂ capture and reuse technologies*. *The Journal of Supercritical Fluids*, 2018. **132**: p. 3-16.
64. Li, M.M.-J. and S.C.E. Tsang, *Bimetallic catalysts for green methanol production via CO₂ and renewable hydrogen: a mini-review and prospects* *Catalysis Science & Technology*, 2018. **8**(14): p. 3450-3464.
65. Kajaste, R., M. Hurme, and P. Oinas, *Methanol-Managing greenhouse gas emissions in the production chain by optimizing the resource base*. *AIMS Energy*, 2018. **6**(6): p. 1074-1102.
66. *Global Methanol Market*. 2018.
67. Dalena, F., et al., *Advances in methanol production and utilization, with particular emphasis toward hydrogen generation via membrane reactor technology* *Membranes*, 2018. **8**(4): p. 98/1-98/27.
68. Schittkowski, J., et al., *Methanol synthesis from steel mill exhaust gases: challenges for the industrial Cu/ZnO/Al₂O₃ catalyst*. *Chem. Ing. Tech.*, 2018. **90**(10): p. 1419-1429.
69. *Methanol Production*. 2020.
70. Ingham, A., *Reducing the carbon intensity of methanol for use as a transport fuel*. *Johnson Matthey Technol. Rev.*, 2017. **61**(4): p. 297-307.
71. Julian Schittkowski, et al., *Methanol Synthesis from Steel Mill Exhaust Gases: Challenges for the Industrial Cu/ZnO/Al₂O₃ Catalyst*. *Chem. Ing. Tech.*, 2018. **90**(10): p. 1419-1429.
72. Griffin, D.W. and M.A. Schultz, *Fuel and chemical products from biomass syngas: a comparison of gas fermentation to thermochemical conversion routes*. *Environmental Progress & Sustainable Energy*, 2012. **31**(2): p. 219-224.
73. *Wood-Ljungdahl pathway*. 2020.
74. Handler, R.M., et al., *Life cycle assessments of ethanol production via gas fermentation: anticipated greenhouse gas emissions for cellulosic and waste gas feedstocks*. *Industrial & Engineering Chemistry Research*, 2016. **55**: p. 3253-3261.
75. LanzaTEch. *The Road to Awesome !* http://aviation.u-tokyo.ac.jp/eventcopy/ws2014/20141105_08Lanzatech%EF%BC%BFHolmgren.pdf. 2014. Tokyo.
76. Willemijn van der Werf. *Advanced Fuels & Chemicals from Waste: Waste in a Circular Economy* -<https://www.ieabioenergy.com/wp-content/uploads/2014/05/P06-Advanced-fuels-and-chemicals-from-waste-van-der-Werf1.pdf>. in *JOINT WORKSHOP: AMF+IEA Bioenergy Infrastructure Compatible Transport Fuels*. 2014. Copenhagen Denmark.
77. LanzaTech. *LanzaTech Presentation*. [cited 2020 March]; Available from: https://www.energy.gov/sites/prod/files/2017/07/f35/BETO_2017WTE-Workshop_SeanSimpson-LanzaTech.pdf.
78. LanzaTech. *CCU-Now: fuels and chemicals from Waste*. 2018 [cited 2020 March]; Available from: https://ec.europa.eu/energy/sites/ener/files/documents/25_sean_simpson-lanzatech.pdf.
79. *Presentation - CCU-Now: fuels and chemicals from waste*. 2018a.
80. Ou, X., et al., *Life-cycle analysis of energy use and greenhouse gas emissions of gas-to-liquid fuel pathway from steel mill off-gas in China by the LanzaTech process*. *Frontiers in Energy*, 2013. **7**: p. 263-270.
81. *STEELANOL- Fueling a Sustainable Future*. [cited 2020 March]; Available from: <https://www.ocelarskaunie.cz/wp-content/uploads/2018/06/Wim-Van-der-Stricht.pdf>.
82. E4tech (UK) Ltd, *The commercial and strategic opportunity offered by gas fermentation in the UK -Final Report for C1Net* <https://ccnet-nibb.co.uk/wp->

- [content/uploads/2018/04/Opportunities-for-gas-fermentation-in-the-UK-Final-Report-July-2016.pdf](#). 2016.
83. GMT. *Accounting Ratios - CAPEX/SALES(%)*. 2020 [cited 2020 March]; Available from: www.gmtresearch.com/en/accounting-ratio/capexsales/.
 84. Zhang, Q., et al., *Comprehensive Assessment of Energy Conservation and CO₂ Emissions Mitigation in China's Iron and Steel Industry Based on Dynamic Material Flows*. Applied Energy, 2018. **209**: p. 251-265.
 85. Worrel, E., et al., *World Best Practice Energy Intensity Values for Selected Industrial Sectors*. 2008, LAWRENCE BERKELEY NATIONAL LABORATORY.
 86. Worrel, E., et al., *Energy Efficiency Improvement and Cost Saving Opportunities for the U.S. Iron and Steel Industry: An ENERGY STAR Guide for Energy and Plant Managers*. 2010, Lawrence Berkley Nation Laboratory.
 87. Pardo, N., J.A. Moya, and K. Vatopoulos, *Prospective Scenarios on Energy Efficiency and CO₂ Emissions in the EU Iron and Steel Industry*. 2012, European Comission Joint Research Centre.
 88. Morrow III, W.R., et al., *Assessment of Energy Efficiency Improvement and CO₂ Emission Reduction Potentials in India's Iron and Steel Industry*. 2013, LAWRENCE BERKELEY NATIONAL LABORATORY.
 89. Krishnan, S.S., et al., *A Study of Energy Efficiency in the Indian Iron and Steel Industry*. 2013, Center for Study of Science, Technology and Policy.
 90. International Energy Agency, *Tracking Energy Efficiency and CO₂ Emissions*. 2007.
 91. Hasanbeigi, A., L. Price, and M. Arens, *Emerging Energy-efficiency and Carbon Dioxide Emissions-reduction Technologies for the Iron and Steel Industry*. 2013, LAWRENCE BERKELEY NATIONAL LABORATORY.
 92. Ernst Worrell, L.P., Maarten Neelis, Christina Galitsky, Zhou Nan, *World Best Practice Energy Intensity Values for Selected Industrial Sectors*. 2008, ERNEST ORLANDO LAWRENCE BERKELEY NATIONAL LABORATORY.
 93. EPA, U.S., *Available and emerging technologies for reducing greenhouse gas emissions from the iron and steel industry*. 2012, EPA (United State).
 94. *Iron and Steel*. [cited June 2019; Available from: <http://ietd.iipnetwork.org/content/iron-and-steel#technology-resources>].
 95. *The State-of-the-Art Clean Technologies (SOACT) for Steelmaking Handbook (2nd Edition) - Asia Pacific Partnership for Clean Development and Climate*. 2010: American Iron and Steel Institute Washington, DC.
 96. Japan, N., *Japanese Technologies for Energy Savings/GHG Emissions Reduction 2008* NEDO Japan.
 97. Pooler, M., *Cleaning up steel is key to tackling climate change*, in *Financial Times*. January 2 2019.
 98. International Energy Agency, *Energy Technology Perspectives 2010*. 2010: Paris, France.
 99. José Antonio Moya, N.P., *The potential for improvements in energy efficiency and CO₂ emissions in the EU27 iron and steel industry under different payback periods*. Journal of Cleaner Production, 2013. **52**(1 August 2013): p. 71-83.
 100. Material Economics, *The Circular Economy a Powerful Force for Climate Mitigation- Transformative innovation for prosperous and low-carbon industry*. 2018, Material Economics Sverige AB
 101. *Another nail in coal's coffin? German steel furnace runs on renewable hydrogen in world first*, in *Renew Economy -Clean Energy News and Analysis*. 2019.
 102. APGTR, *Australian Power Generation Technology Report*, G. Bongers, Editor. 2015: Australia.
 103. Macrotrends. *Australian - US Dollar Exchange Rate (AUD USD) - Historical Chart*. 2019 [cited 2019 September 12]; Available from: <https://www.macrotrends.net/2551/australian-us-dollar-exchange-rate-historical-chart>.
 104. Water NSW. *2018 -19 Water Pricing*. [cited 2019 September 17]; Available from: <https://www.watarnsw.com.au/customer-service/ordering-trading-and-pricing/pricing/2018-19-water-pricing>.

105. AIP. *National Retail Diesel Prices*. 2019 [cited 2019 September 17]; Available from: <https://aip.com.au/pricing/national-retail-diesel-prices>.
106. Chiyoda Corporation, *Preliminary Feasibility Study on CO₂ Carrier for Ship-based CCS*. 2011, Global Carbon Capture and Storage Institute Ltd: Canberra, Australia.
107. Allison, G., et al., *CO₂CRC CCS Economic Methodology and Assumptions*. 2012, Cooperative Research Centre for Greenhouse Gas Technologies: Canberra, Australia.
108. IEAGHG R&D Programme, *Ship Transport of CO₂: Report number PH4/30*. 2004.
109. AEMO. *Data Dashboard - Average Price Tables*. 2019 [cited 2019 October 31]; Available from: <https://www.aemo.com.au/Electricity/National-Electricity-Market-NEM/Data-dashboard#average-price-table>.
110. Decarre, S., et al., *CO₂ maritime transportation*. *International Journal of Greenhouse Gas Control*, 2010. **4**(5): p. 857-864.

BUILDING A LOW-EMISSIONS FUTURE

CO2CRC Limited

11–15 Argyle Place South

Carlton VIC 3053

Australia

p: +61 3 8595 9600

e: info@co2crc.com.au

www.co2crc.com.au



PARTNERS

CO2CRC acknowledges and appreciates the strong relationships it has with industry, community, government, research organisations, and agencies in Australia and around the world

INDUSTRY



ANLEC R&D
(on behalf of COAL 21)
BHP
Chevron Australia
COAL 21
ExxonMobil
Global CCS Institute
J-POWER
Shell Australia
Total
Woodside Energy

GOVERNMENT

Australian Government:
Department of Education and
Training
Australian Government:
Department of Industry,
Innovation and Science
CarbonNet Project
Coal Innovation NSW
NSW: Department of Planning
and Environment
Victoria: Department of Jobs,
Precincts and Regions



COMMUNITY

Landowners near Otway National
Research Facility
Moyne Shire
Nirranda South



RESEARCH

Australian National University
CSIRO
Curtin University
Federation University Australia
Geoscience Australia
Helmholtz Centre Potsdam –
GFZ German Research Centre
for Geosciences
King Abdullah University of
Science and Technology
(KAUST)

Lawrence Berkeley National
Laboratory (LBNL)
Stanford University
University of Adelaide
University of Cambridge
University of Edinburgh
University of Melbourne
University of NSW
University of Western Australia
University of Wollongong
UK CCS Research Centre

