

**NSW
Resources
Regulator**

GUIDE

Health and safety at quarries

NOVEMBER 2018



GOOD PRACTICE GUIDELINES

This guideline gives practical advice on health and safety control measures at quarries. The guideline also applies to surface sand, gemstone and alluvial mines and dredging operations.

This guide does not apply to coal mines.

ACKNOWLEDGEMENTS

The NSW Resources Regulator would like to thank WorkSafe New Zealand for permission to reproduce parts of its publication Health and safety at opencast mines, alluvial mines and quarries.

The NSW Resources Regulator would also like to thank industry representatives from CCAA, IQA, Hanson, Holcim and Boral for the input provided.

Published by NSW Department of Planning and Environment, NSW Resources Regulator

Title: Health and safety at quarries

First published: August 2018

Document control

CM9 Reference: PUB18/184

AMENDMENT SCHEDULE		
Date	Version #	Amendment
20 November 2018	v1.1	Updates made to Tyre Safety section (pages 255-257) Updated figure 54 (page 139)

© State of New South Wales through the NSW Department of Planning and Environment 2018.

This publication is copyright. You may download, display, print and reproduce this material in an unaltered form only (retaining this notice) for your personal use or for non-commercial use within your organisation. To copy, adapt, publish, distribute or commercialise any of this publication you will need to seek permission from the NSW Department of Planning and Environment.

Disclaimer: The information contained in this publication is based on knowledge and understanding at the time of writing (August 2018). However, because of advances in knowledge, users are reminded of the need to ensure that information upon which they rely is up to date and to check currency of the information with the appropriate officer of the NSW Department of Planning and Environment or the user's independent advisor.

HEALTH AND SAFETY AT QUARRIES

KEY POINTS:

Have a well-planned, designed and maintained work site with an appropriate safety management system.

Have a well-developed emergency plan, developed in consultation with your local emergency services.

All workers must be trained and competent for the work they do, including any required certifications.

Notify the site location, nature of the mine, operator's details and key statutory people to the NSW Resources Regulator.

Ensure all machinery is equipped with appropriate guarding.

Ensure all mobile equipment is operated safely by competent operators, is fit-for-purpose and appropriate procedures are in place for high-risk activities such as tipping and scaling.

Develop and implement roads and traffic management plans to control the segregation of vehicles to minimise interactions between heavy and light vehicles, structures and pedestrians.

Ensure that the use of explosives is well controlled and blasting is carried out by competent people.

TABLE OF CONTENTS

PART A 10

INTRODUCTION 11

1.1	How to use this guide	12
1.2	Background	12
1.3	Purpose	12
1.4	Scope and application	13
1.5	What is a mine?	13
1.6	Interpretation	14
1.7	Safety-critical Roles	14

SAFETY MANAGEMENT SYSTEM 17

2.1	Applicable Legislation: Risk management in WHS laws	18
2.2	The Safety Management System (SMS)	18
2.3	Identifying hazards and analysing risk	20
2.4	Risk assessment	20
2.5	Principal hazard management plans and Principal control plans	21
2.6	Hazard control	23
2.7	Hazard Monitoring	24
2.8	Hazard reporting	24
2.9	Other PCBUs	24
2.10	Incident reporting, investigation and record keeping	26

PART B

30

PLANNING FOR EXCAVATION 31

3.1	Terminology	33
3.2	Identifying ground or strata failure principal hazard	33
3.3	Ground or strata failure Principal hazard management plan (PHMP)	37
3.4	Geotechnical assessment	37
3.5	Slope design	39
3.6	Ground support and reinforcement systems	43
3.7	Maintaining control over the excavation	45

PLANNING FOR DUMPS, PONDS, VOIDS AND DAMS 47

4.1	Identifying dumps, dams and voids as a principal hazard	48
4.2	Principal hazard management plan (PHMP)	50
4.3	Planning and design criteria for dumps	51
4.4	Planning and design criteria for dumps, ponds or dams	52
4.5	Construction of a dump or dam	53
4.6	Rehabilitation of dumps	56
4.7	Maintaining control over dumps, dams and voids	56

PLANNING FOR ROADS AND VEHICLE OPERATING AREAS 58

5.1	Identifying roads and other vehicle operating areas	59
5.2	Roads and other vehicle operating areas Principal hazard management plan	60
5.3	Design and layout of roads	61
5.4	Maintaining control over roads and other vehicle operating areas	79

PART C

80

USING EXPLOSIVES **81**

6.1	Hazard management and emergency planning for explosives	83
6.2	Maintaining, transporting and storing explosives	84
6.3	Shot-firing – safe systems of work	86
6.4	Explosives selection criteria	88
6.5	Drilling, charging and blasting	89
6.6	Post-firing	97
6.7	Minimising blast damage	102

CONTROLLING GROUND INSTABILITY IN EXCAVATIONS **104**

7.1	Planning and design	105
7.2	Excavation rules	105
7.3	Excavation control and scaling	106
7.4	Slope movement monitoring programs	110
7.5	Remedial measures	111
7.6	Historic underground workings	114
7.7	Working near slopes	116

DUMPING (OR TIPPING) **118**

8.1	Dumping methods	120
8.2	Controlling end-tipping risks	120
8.3	General risk controls	125
8.4	Procedures for examining dump heads	130
8.5	Dump maintenance and inspection	130
8.6	Other considerations for stockpiles	132
8.7	Reworking and reshaping dumps	133

MINING IN OR ADJACENT TO WATER BODIES **134**

9.1	Planning and design	135
9.2	Excavation rules	135
9.3	Extracting beneath water	135
9.4	Floating plant and boats	137

WATER OR TAILINGS STORAGE **144**

10.1	Inspections and tell-tale signs of distress	145
10.2	Technical operational review	147
10.3	Cleaning out ponds	147

TRAFFIC MANAGEMENT **149**

11.1	Site access: contractors, visitors and public	150
11.2	Power lines and other overhead structures	152
11.3	Reversing, manoeuvring and parking	154
11.4	Loading vehicles	157
11.5	Loading floating plant	160
11.6	Loading and storage of large stone slabs or blocks	160
11.7	Feeding crushers	160
11.8	Railway sidings	161
11.9	Safe drivers and vehicles	161
11.10	Maintenance and repair of roads	168
11.11	Cleaning trailers fitted with tailgates	168

PART D

170

PLANT AND STRUCTURES 171

12.1	Scope	172
12.2	Consideration of plant and structures principal hazards	173
12.3	Mechanical engineering and electrical engineering control plans	173
12.4	Acquisition of plant and structures	177
12.5	Existing plant or structure	179
12.6	Location of machinery	179
12.7	Access to plant and structure	179
12.8	Guarding	181
12.9	Conveyors	193
12.10	Emergency stops	196
12.11	Pre-start warning systems	197
12.12	Electricity	198
12.13	Cranes and lifting equipment	203
12.14	Pressure vessel equipment	204
12.15	Lifecycle management of plant and structures	205

WORKER FACILITIES 207

13.1	Washing facilities	208
13.2	Toilets	208
13.3	Drinking water	209
13.4	First Aid	209
13.5	Facilities for changing and storing clothes	210
13.6	Facilities for meals	210
13.7	Outdoor work	210
13.8	Remote or isolated work	210

SITE SECURITY AND PUBLIC SAFETY **212**

14.1	Access to sites	213
14.2	Barriers	213
14.3	Signs	214

WORKER HEALTH **215**

15.1	Health control plan	216
15.2	Exposure monitoring	218
15.3	Health monitoring	218
15.4	Noise	219
15.5	Vibration	220
15.6	Atmospheric contaminants	221
15.7	Working in extreme temperatures	225
15.8	Hazardous manual tasks	226
15.9	Hours of work and fatigue	228
15.10	Mental health	228
15.11	Ultraviolet radiation	230
15.12	Contaminated land	230
15.13	Hazardous substances	230
15.14	Drugs and alcohol	232
15.15	Personal protective equipment (PPE)	233
15.16	Hazard classifications	235

PREVENTING FALLS FROM HEIGHT 237

16.1	Access and egress to mobile plant	239
16.2	Access and egress to heavy vehicle working areas	240
16.3	Covering loads	241
16.4	Access to fixed plant and machinery	242
16.5	Portable ladders	243
16.6	Working near highwalls or faces	243

MAINTENANCE AND REPAIRS 245

17.1	Common hazards when undertaking maintenance	247
17.2	Isolation and lock-out of energy	253
17.3	Permit to work systems	254
17.4	Inspecting and servicing mobile plant	255
17.5	Blocked crushers or hoppers	262
17.6	Pugmill mixers	264

EMERGENCY MANAGEMENT 271

18.1	What is an emergency and what are my duties?	272
18.2	Keep it simple and proportionate to the size of the operation	274
18.3	All emergency management plans should be based on the coordinated incident management system	275
18.4	Assess potential emergencies	275
18.5	Identify needs and confirm capability requirements	276
18.6	Make the plan	277
18.7	Test, practice and review the plan	283

WORKER PARTICIPATION	285
<hr/>	
19.1 Effective consultation	286
19.2 When you must consult workers	286
19.3 Workers' safety role	287
19.4 Worker representation	287
<hr/>	
INFORMATION, TRAINING AND SUPERVISION	288
<hr/>	
20.1 Information, training, instruction or supervision	289
20.2 Training	290
20.3 Identify skills, knowledge or competencies	290
20.4 Induction training	290
20.5 Providing information	291
20.6 Training workers	291
20.7 Supervision	292
20.8 Use of contractors	292
20.9 Training records	292
<hr/>	
GLOSSARY	293
<hr/>	
REFERENCES	300
<hr/>	



**PART
A**

This part of the document gives an introduction, background and definitions to help you use it. It includes a discussion of what quarries and mines this document applies to, and a guide to the overall practice of risk management.



01

PART A

Introduction

IN THIS SECTION:

- 1.1 How to use this guide**
- 1.2 Background**
- 1.3 Purpose**
- 1.4 Scope and application**
- 1.5 What is a mine?**
- 1.6 Interpretation**
- 1.7 Safety-critical roles**

This guide is about helping you implement hazard controls for risks commonly associated with surface metalliferous and extractives operations.

1.1 HOW TO USE THIS GUIDE

This document has four parts:

PART A: INTRODUCTION

This part gives an introduction, background and definitions to help use this document. Part A includes a discussion of what quarries and mines this document applies to, and guidance on the overall practice of hazard management.

PART B: PLANNING AND DESIGN

This part provides guidance on planning safety into mine and quarry operations. It describes in detail how to plan excavations, dumps, dams, roads and vehicle operating areas.

PART C: OPERATIONAL SAFETY FOR MINING AND QUARRYING

This part sets out site safety practices for working with explosives, managing ground instability, tipping and dumping material, storing water and tailings and managing traffic.

PART D: EMERGENCY MANAGEMENT AND OPERATIONAL SAFETY FOR EQUIPMENT AND PEOPLE

This part provides guidance on managing machinery, worker health and training and emergencies.

1.2 BACKGROUND

The *Work Health and Safety (Mines and Petroleum Sites) Act 2013* (the WHSMPS Act), and the *Work Health and Safety (Mines and Petroleum Sites) Regulation 2014* (the WHSMPS Regulation) have specific provisions for safety in mining operations, which applies to quarries, surface metalliferous, sand, gemstone and alluvial mines and dredging operations.

The NSW Resources Regulator recognises that quarries and small mines need specific health and safety guidance.

The NSW Resources Regulator, in consultation with the industry, is developing and updating codes of practices and guidance material that industry can use as tools to assist in complying with the WHSMPS legislation.

1.3 PURPOSE

This document has been developed to assist quarries, surface metalliferous, alluvial and gemstone mines and dredging operations in identifying principal hazards and other types of hazards, and developing, implementing and maintaining controls for the risks arising from those hazards. This document will also assist these mines to meet their obligations under the *Work Health and Safety Act 2011* (WHS Act) and the WHSMPS Act and their associated regulations. Together this legislation is referred to as the WHS laws.

1.4 SCOPE AND APPLICATION

This document applies to quarries, surface metalliferous, alluvial and gemstone mines, and dredging operations. This document is mainly for mine operators, mine managers, other persons conducting a business or undertaking (PCBUs), workers and worker representatives. Workers, health and safety advisers, consultants and engineers may also find it helpful.

This document does not apply to coal mines or underground mines.

The precautions required in a situation will depend on the extent and nature of the risks involved. High-risk situations require higher standards of precautions than low-risk situations. Examples given do not cover every possible situation and may not be relevant to all sites. You should complete your own risk assessments and take competent advice when implementing health and safety management systems.

1.5 WHAT IS A MINE?

Under the WHSMPS Act, a mine is a place at which mining operations are carried out. The meaning of the term 'mining operations' is set out in section 7 of the WHSMPS Act. In considering whether particular activities are 'mining operations' it is important to understand that each situation must be considered on its own circumstances and no individual factor or element will be definitive in all cases.

The definition supports a holistic approach to the management of safety at the mine and avoids the need to constantly distinguish between mining activities and other activities, or to apply arbitrary distinctions that may not reflect how individual mining businesses are organised.

WHAT ARE MINING OPERATIONS?

Mining operations are made up of several types of pursuits. Firstly, mining activities, which are activities carried out for the purpose of:

- > exploring for minerals
- > extracting minerals from the ground
- > injecting minerals into the ground, but only where the primary purpose of the injection is to inject a mineral into the ground or to return a mineral to the ground (e.g. in carbon sequestration).

Secondly, there are activities carried out in connection with mining activities at a local site. A local site in relation to mining activities is the site at which those activities are carried out, or a site that adjoins, or is in the vicinity of, the site at which those activities are carried out.

Mining operations include such things as the handling, preparing, processing or storing of extracted materials carried out in connection with mining activities at a local site.

Mining operations also include such things as constructing a mine site, or constructing a place where handling, preparing, processing or storing of extracted materials will take place at a local site. It also includes activities associated with decommissioning, making safe or closing an extraction site or exploration site.

Mining operations also includes educational and tourist activities carried out in connection with mining activities at a local site, or former mining activities at a site where those activities were carried out, for example, if tours of the site are provided at an operating mine.

The guide *Understanding the term 'mining operations'* provides additional details.

WHAT THIS GUIDE COVERS

What is a mine will vary between different operations. For the purpose of this guide, it is assumed that the following areas form part of a surface metalliferous, alluvial or extractives mine:

- > all the surface extraction workings including preparatory and abandonment works
- > dump (or dumps) associated with mining activities at a local site
- > working stockpiles associated with mining activities at a local site
- > settling dams associated with mining activities at a local site
- > areas used for processing extracted materials (including washing, drying and bagging), where the processing is carried out at a local site
- > areas used for crushing or screening extracted or processed materials at a local site,
- > the buildings and structures at the mine used for the working of the mine
- > common areas (e.g. quarry roadways and railways, but not public roads or public railways).

The above areas may form part of the mine regardless of whether the extraction is of an intermittent nature or not.

Mine holders (e.g. the person with a right to mine) must notify the regulator as to who will operate the mine (WHSMPs Regulation clause 24).

If you are unsure whether your operation is a mine as defined by section 7 of the WHSMPs Act, you should obtain legal advice.

1.6 INTERPRETATION

The WHS laws require duty holders to have effective ways of managing health and safety. Duty holders are not legally required to use this guidance, but it will help them to comply with the law. Alternative methods may be used, but these should be at least as safe, or better than those set out within.

This document brings together legal obligations, along with other recommendations that are not legal requirements but are good practice.

For the purposes of this document the words 'must', 'requires' or 'mandatory' indicate that legal requirements exist and must be complied with. The word 'should' indicates a recommended course of action, while 'may' indicates an optional course of action.

1.7 SAFETY-CRITICAL ROLES

1.7.1 MINE OPERATOR

The mine holder must operate the mine or appoint someone else to the position of mine operator to operate the mine.

The mine operator is a key duty holder under the WHS Act and Regulation. Their responsibilities include developing and implementing a safety management system that is used as the primary means of ensuring, so far as is reasonably practicable:

- > the health and safety of workers at the mine
- > that the health and safety of other people are not put at risk from the mine or work carried out as part of mining operations.

The mine operator's responsibilities include:

- > nominating workers to safety-critical roles
- > making sure hazards are identified and controlled
- > providing the resources to implement the safety management system for the mine.

1.7.2 STATUTORY FUNCTIONS

Schedule 10 of the WHSMPS Regulation identifies a series of functions for different classes of mines that are known as 'statutory functions'. Only people meeting specified requirements are eligible to be nominated by the mine operator to exercise a statutory function.

Certain functions have been identified as key statutory functions.

Mining activities are prohibited if the mine operator has not nominated a worker to perform a key statutory function, or that position has been vacant for more than seven days.

However, this prohibition does not prevent exploration for minerals by means other than mechanical means that disturb the ground.

The worker nominated to perform a statutory function at a mine must be readily available to exercise, and is capable of exercising, the statutory function.

Only one worker can be nominated to exercise a key statutory function at any one time.

The *Statutory functions guide* has more information about statutory functions.

QUARRY MANAGER

For surface mining operations (other than coal mines) one of the key statutory functions is that of quarry manager. The role of a quarry manager is to supervise mining operations at the mine.

To be nominated as a quarry manager and exercise this statutory function, a person must hold a practising certificate. To apply for a practising certificate, a person must have one of the following qualifications:

- > a certificate of competence as a quarry manager
- > one of the following former certificates:
 - a certificate of competence to be a production manager (for either an above ground mine or an underground mine) issued under the *Mine Health and Safety Act 2004*
 - a production manager permit (limited by and subject to all the conditions of the permit) granted Under the *Mine Health and Safety Act 2004* (including permits granted after commencement of the WHSMPS Act).

A practising certificate to be a quarry manager of a mine or mines, other than an underground mine or coal mine, may be subject to conditions that limit the application of the practising certificate to a particular mine or mines. Further information relating to quarry manager practising certificates can be found in the *Guide to the quarry manager practising certificate*, available from the Resources Regulator's website.

ELECTRICAL ENGINEER

The function of electrical engineer is a key statutory function at surface mines (other than coal mines). An electrical engineer is required to be nominated if total connected power at the mine is greater than 1000 kilowatts or high voltage electricity is used.

The role of the electrical engineer is to develop and review the standards and procedures for the installation, commissioning, maintenance and repair of electrical plant and installations at the mine, and to supervise the installation, commissioning, maintenance and repair of electrical plant and installations at the mine. The electrical engineer must also develop and periodically review the electrical engineering control plan, or supervise a person to develop and periodically review the electrical engineering control plan.

A person is eligible to be nominated as an electrical engineer if they have one of the following qualifications:

- > electrical engineer manager practising certificate (underground coal mines)
- > electrical engineering manager practising certificate of competence (coal mines other than underground mines)
- > a certificate of competence to be a mine electrical engineer (for either underground coal or surface coal) (under the *Coal Mine Health and Safety Act 2002*)
- > evidence of compliance with Australian Engineering Competency Standards Stage 2 in respect of mining operations at a mine and be registered on the National Engineering Register as:
 - i. a professional electrical engineer or
 - ii. an electrical engineering technologist or
 - iii. an electrical engineering associate.

OTHER STATUTORY FUNCTIONS

There are two other statutory functions at surface mines and quarries:

- > Mining surveyor (only required if mine survey plan is required)
- > Qualified electrical tradesperson.

The *Statutory functions guide* provides more information on their role and eligibility to be nominated to these roles.

Even if there are no mandatory statutory functions for particular activities the mine operator must still ensure that staff are competent to undertake the tasks assigned to them. Key competencies to consider include:

- > a competent person to develop the mechanical engineering control plan
- > plant operators (whether or not they are required to hold a high-risk work licence)
- > plant repairers such as mechanical tradespeople.

A background image showing two construction workers in profile, facing each other. The worker on the left is wearing a yellow hard hat, sunglasses, and a high-visibility vest. The worker on the right is wearing a red hard hat and a high-visibility vest. The image is partially obscured by a purple overlay on the right side.

02

PART A

Safety management system

IN THIS SECTION:

- 2.1 Applicable legislation: risk management in WHS laws**
- 2.2 The safety management system (SMS)**
- 2.3 Identifying hazards and analysing risk**
- 2.4 Risk assessment**
- 2.5 Principal hazard management plans and principal control plans**
- 2.6 Hazard control**
- 2.7 Hazard monitoring**
- 2.8 Responding to hazard reports**
- 2.9 Other PCBUs**
- 2.10 Incident reporting, investigation and record keeping**

Ensuring hazards do not cause harm is the basis of health and safety in any workplace. A safety management system is how you identify and control hazards in your workplace.

This section describes:

- > the legislative requirement to have a safety management system (SMS)
- > the components your SMS needs to have
- > the legislative requirement to identify risks and manage certain hazards using principal hazard management plans (PHMPs)
- > the basic concepts of hazard identification, risk assessment, and risk management
- > the legislative requirement to report, record and investigate incidents.

2.1 APPLICABLE LEGISLATION: RISK MANAGEMENT IN WHS LAWS

The WHS Act covers all workplaces and requires persons conducting a business or undertaking (PCBUs) to take all reasonably practicable steps to ensure the health and safety of workers and others. There are also duties on workers and others in the workplace such as visitors.

The WHSMPS Regulation places additional health and safety duties on mine operators and other PCBUs at a mine. It includes specific requirements for the management of all risks as well as requirements for particular types of hazards.

A principal hazard is defined in clause 5 of the WHSMPS Regulation. In summary, a principal hazard is any hazard that could create a risk of multiple fatalities at a mining operation, either in a single incident or in a series of recurring incidents.

A mining operation must identify what principal hazards they have on site, and must have a principal hazard management plan for each of these principal hazards.

There are other hazards on a mine site that are not classed as principal hazards. These require a principal control plan (PCP), and are specified in clause 26 of the Regulations.

The mine must also have an emergency management plan, as specified in clause 88 of the Regulations.

2.2 THE SAFETY MANAGEMENT SYSTEM (SMS)

Mining operations including quarries and other extractive operations must have a SMS.

The SMS is to set out a level of detail appropriate for the nature, size, complexity and hazards of the mining operation, and any other relevant matters.

Different approaches and formats may be used to develop a SMS. Regardless of the structure adopted for the SMS, it must include a systematic approach to hazard management and should be part of, and integrated with, the overall management system of the mine.



A SMS must include:

- > a health and safety policy
- > the process used to identify hazards, assess the risk of harm and to identify controls to manage these hazards. This could include safe work method statements (SWMS) or standard operating procedures (SOP)
- > a description of the systems, procedures and other risk control measures in place to manage hazards and to respond to increased levels of risks, including principal hazard management plans (PHMPs) and principal control plans (PCPs)
- > the management structure for work, health and safety, including competency requirements for positions in the structure, how temporary and permanent vacancies will be filled, requirements for acting positions in the structure and for key statutory functions, the responsibilities of each person with regard to the supervision of workers
- > arrangements for consultation, co-operation and co-ordination of activities of other PCBUs at the mine
- > arrangements for having work undertaken by contractors
- > an emergency management plan, about how the mine will manage an emergency situation, including the withdrawal of workers to a place of safety
- > the provision of information, training and instruction to workers
- > induction procedures for workers
- > the arrangements for supervision of workers and other people to protect them from health and safety risks
- > how monitoring of health and safety of mine workers will be performed
- > the worker consultation and safety role
- > how reporting of notifiable incidents will be achieved and how these incidents will be investigated
- > how control measures will be reviewed
- > how records are managed
- > how effective communication of relevant information is made across shifts (where applicable) by workers, supervisors and other relevant people
- > how monitoring, assessment and inspections of working places will be undertaken
- > performance standards for measuring the effectiveness of the SMS, including how effective the SMS is, how it will be continually improved, how the performance standards will be met, and auditing how effective the SMS is against the performance standards
- > the resources that will be applied for the effective implementation and use of the SMS
- > any other requirements of the WHSMPS Regulations.

For more detailed information on developing an SMS, see the *Safety management systems in mines code of practice*.

The SMS must be developed in consultation with workers at the site. It must be easily understood and made available to all workers.

The SMS must be in place from the commencement of mining operations, including exploration until the closure of the mine, but its content will vary over time. For example, if the mine is being expanded and this will involve construction work, the SMS would need to be updated to include any additional or specific matters relevant to the construction work before that work starts.

2.3 IDENTIFYING HAZARDS AND ANALYSING RISK

You must ensure an effective method is in place to systematically identify and regularly assess hazards to workers at your site.

Clause 9 of the WHSMPS Regulation outlines the process for PCBUs at mines to identify, assess and control hazards, including reviewing control measures to ensure they remain effective.

Clause 23 of the WHSMPS Regulation outlines the duty to identify and assess principal hazards in a mining operation. So, by using clause 23 of the WHSMPS Regulation to identify which principal hazards exist on your mine site, you then use clause 9 to assess these hazards and determine the controls you will implement.

To identify other hazards and to assess them, as well as assessing the principal hazards, there are a number of ways to undertake that process:

- > Physical inspections: Inspect the workplace and identify where someone could get hurt.
- > Task and process analysis: Identify the hazards involved in each task. This should include what happens when intervention is required (e.g. breakdowns). Identify hazards at each stage of the production process.
- > Use best practice guidelines and standards.
- > Hazard and operability study (HAZOP).
- > Accident investigation analysis: Identify hazards and causes of harm from investigations involving similar types of work.
- > Near miss, audit or inspection analysis: Trends or common problems can be identified from near-miss reports, audits or inspections. Analysis of these reports may show locations that are more dangerous and indicate problems with the design and layout of that work area or the way work is carried out there.
- > Work environment monitoring (e.g. noise assessment, air quality assessment (dust)).
- > Analytical techniques for calculating the hazard (e.g. geotechnical data for ground stability).

2.4 RISK ASSESSMENT

Risk is a measure of the consequence and likelihood of a negative effect on the safety of people, equipment, infrastructure or the environment. A risk assessment can be either qualitative (i.e. rankings or descriptive indicators) or quantitative (i.e. numerical estimates).

A risk assessment involves considering what could happen if someone is exposed to a hazard, assessing the likelihood of it happening, and what would be the consequence if it did happen. By then considering ways to control the hazard, the risk is reduced and you keep adding controls until the risk is acceptable.

It is part of the requirements of the WHSMPS Regulation that a risk assessment is undertaken for all hazards associated with mining operations.

A risk assessment can help you determine:

- > the likelihood of a hazard occurring
- > the severity of the outcome when someone is exposed to the hazard
- > whether existing control measures are effective
- > what additional controls you should implement
- > how urgently action needs to be taken.



Some hazards that have exposure standards, such as noise and airborne contaminants, may need scientific testing or measurement by a competent person. This is to accurately assess the risk and to check the relevant exposure standard is not being exceeded (e.g. noise meters to measure noise levels and personal dust samplers to measure airborne dust).

Similarly, geotechnical or ground failure risk may be a complex issue and require a competent person for assessment.

2.5 PRINCIPAL HAZARD MANAGEMENT PLANS AND PRINCIPAL CONTROL PLANS

A principal hazard is one that could cause multiple fatalities, either in a single incident or in a series of recurring incidents.

The WHSMPS Regulation (clause 5) lists hazards that have historically shown to be principal hazards, but is not exhaustive. You have to determine if there are other hazards on site that fall under the definition of a principal hazard.

Then for each identified principal hazard a principal hazard management plan must be developed for that hazard.

If a particular principal hazard is not present, a PHMP will not be required.

2.5.1 PRINCIPAL HAZARD MANAGEMENT PLANS (PHMP)

A PHMP should provide for the management of all aspects of risk control in relation to the particular principal hazard.

A PHMP must be in writing and include:

- > a description of the nature of the principal hazard
- > how the principal hazard relates to other hazards associated at the mine
- > how the principal hazard was identified
- > the most recent risk assessment conducted in relation to the principal hazard
- > all control measures to be implemented to manage risks to health and safety associated with the principal hazard (this should include any controls specified in the WHSMPS Regulation)
- > the arrangements in place for providing the information, training and instruction required in relation to the principal hazard
- > any design principles, engineering standards and technical standards relied on for control measures for the principal hazard
- > the reasons for adopting or rejecting each control measure considered.

The WHSMPS Regulation Schedule 1 sets out a range of matters that must be considered when developing control measures. Schedule 1 is a useful tool to check that you have not missed anything during the risk assessment process.

2.5.2 PRINCIPAL CONTROL PLANS (PCP)

The purpose of a PCP is to link the duties and functions of the people, the equipment and the environment in which they operate.

Clause 26 of the WHSMPS Regulation identifies the principal control plans. Clause 88 of the WHSMPS Regulation requires the development of an emergency plan. Some plans are mandatory, the others are needed if the hazard being controlled exists on the mine site. You may also develop your own control plan for a hazard you have that is not listed.

The following plans are mandatory:

- > health control plan
- > emergency plan

The following plans are needed if the hazard exists on the mine site:

- > Mechanical Engineering control plan
- > Electrical Engineering control plan
- > Explosives control plan.

All plans require the mine operator to prepare the plans, however the mechanical and electrical engineering plans also require the respective plan to be developed and reviewed by the statutory mechanical engineer or a competent person (if no mechanical engineer is nominated) or the statutory electrical engineer or a competent person (if no electrical engineer is nominated).

Some control measures may be used to control the risks associated with more than one hazard. This may include principal hazards and other hazards. These can be included in a PHMP or PCP and will then manage the controls for all areas where the hazard exists.

A PCP should still show the hazard and the analysis resulting in the risk and identify the controls and how they are implemented (i.e. via another plan).

Assistance with preparing PCPs can be found in the *Safety management systems in mines code of practice*.

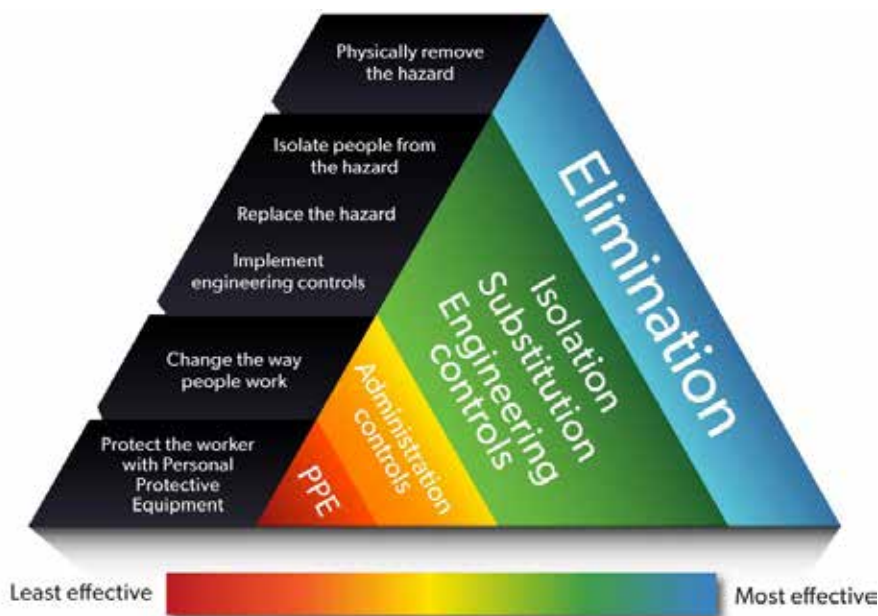

Figure 1. Hierarchy of controls

2.6 HAZARD CONTROL

The ways of controlling hazards are ranked from the highest level of protection and reliability to the lowest as shown in Figure 1. This is known as the hierarchy of controls. Clause 9 of the Regulation (by incorporating Part 3.1 of the WHS Regulation) requires PCBUs at mines to work through this hierarchy when managing hazards arising from mining operations.

ELIMINATION

The most effective control measure is to eliminate the hazard and associated risk. You must always aim to eliminate a hazard, where reasonably practicable. The best way to do this is by not introducing the hazard into the workplace. For example, you can eliminate the risk of a fall from height by doing the work at ground level.

Eliminating hazards is often cheaper and more practical to achieve at the design or planning stage. In these early stages, there is greater scope to design out hazards or incorporate risk control measures that are compatible with the original design and functional requirements. For example, a noisy machine could be designed and built to produce as little noise as possible, which is more effective than providing workers with personal hearing protectors.

You can eliminate risks by removing the hazard completely, e.g. by removing trip hazards on the floor or disposing of unwanted chemicals.

It may not be possible to eliminate a hazard if doing so means that you cannot manufacture the end product or correctly deliver the service.

SUBSTITUTION, ISOLATION AND ENGINEERING CONTROLS

If you cannot eliminate the risk, then you must minimise those risks associated with the hazard so far as is reasonably practicable. This may include:

- > substituting the hazard with something safer (e.g. replacing solvent-based paints with water-based ones)
- > isolating people from the hazard
- > using engineering controls to minimise the risk associated with the hazard.

Isolating people from the hazard involves physically separating the source of harm from people by distance or using barriers. For example, you could install guard rails around exposed edges and holes in floors, use remote control systems to operate machinery or store chemicals in a fume cabinet. Isolation controls can include engineering controls.

Engineering controls are physical in nature. For example, you could use mechanical devices such as trolleys or hoists to move heavy loads or place guards around moving parts of machinery or install residual current devices (electrical safety switches) and so on.

MINIMISATION

Minimisation control measures do not control the hazard at the source. They rely on human behaviour and supervision and used on their own, tend to be least effective in minimising risks. Two approaches to reduce risk in this way are:

- > **Administrative controls:** Work methods or procedures that are designed to minimise exposure to a hazard; for example, developing procedures on how to operate machinery safely, limiting exposure time to a hazardous task and using signs to warn people of a hazard.

- > **Using personal protective equipment (PPE):** For example, ear muffs, respirators, face masks, hard hats, gloves, and safety glasses. PPE limits exposure to the harmful effects of a hazard but only if workers wear and use the PPE correctly.

You should not rely on administrative controls as the only control mechanism against the hazard.

Only use administrative controls and PPE:

- > where no other practicable controls are available (as a last resort)
- > as an interim measure until a more effective control can be used.

Administrative controls should be used to supplement higher level controls.

For example, where a machine produces dust, an engineering control could be to extract and exhaust the dust, but the worker still wears a mask (PPE) as a back-up control.

Where workers are exposed to some hazardous substances such as crystalline silica that cannot be eliminated, along with controlling exposure to the hazard, the operator must monitor workers' exposure to the hazard and monitor their health. Workers must be consulted about health monitoring arrangements including in relation to the choice of doctor (see section 15.2).

With changes in technology and cost of controls over time, methods to eliminate and isolate a hazard that were once considered not practicable may become practicable. You must continue to assess significant hazards that are being minimised to determine whether other methods are available to control them. That is why a regular review of the SMS and its components must be done, as is required by legislation.

An example is, replace or upgrade older vehicles with ones with better safety devices such as anti-lock brakes, traction control and retarders.

2.7 HAZARD MONITORING

You must regularly review your operations to identify any new hazards that may have arisen since a previous assessment.

You must also maintain and review the controls you have in place to ensure the controls are still relevant and effective.

Under clause 15 of the Regulation, mine operators must include performance standards in the safety management system against which they audit and review the effectiveness of the system.

2.8 HAZARD REPORTING

Mine operators should ensure hazards reported by mine workers are investigated. This should be completed as soon as practicable, considering the seriousness of the hazard.

PCBUs at a mine must ensure that workers engaged by them are trained and competent in the basic risk management techniques used at the mine having regard to the nature of the work carried out by the worker. A part of this training should include how to identify hazards and how to report them to their supervisor.

2.9 OTHER PCBUS

The WHSMPS Regulation includes a range of provisions that relate to or impact on the relationship between the operator and other businesses who do work at a mine site. In the WHSMPS Regulation and in this guide, the term contractor refers to a contractor who conducts a business or undertaking at a mine other than a delivery, office equipment service, office cleaning or catering business.



2.9.1 CONTRACTOR ARRANGEMENTS

DUTY TO PROVIDE INFORMATION AND ACCESS

The operator of a mine site has a duty to ensure that a contractor at the mine receives all relevant information as well as access to the mine, to enable the contractor to identify any risks associated with the proposed operations.

The contractor has a duty to ensure that the operator of a mine is given all relevant information – so far as is reasonably practicable – to allow the operator of the mine to identify any risks that may be associated with the proposed operations that the contractor will carry out.

What is considered relevant will depend on the circumstances. It is likely that some discussion between the parties will be required to identify what types of information may be relevant and ensure incorrect assumptions are not made by either party.

2.9.2 CONFIRMING THE ARRANGEMENTS FOR ENSURING HEALTH AND SAFETY

The WHSMPS Regulation requires a formal process for the contractor and the operator of the mine site to consider and agree on the arrangements for ensuring the safety of workers. Before a contractor can carry out work for the mining operation, they must have either:

1. prepared a contractor health and safety management plan and:
 - provided a copy of their plan to the operator of the mine and obtained written notice from the operator that the operator has reviewed the plan and is of the opinion that the plan is consistent with the SMS for the mine, or
2. reviewed the relevant parts of the SMS for the mine and given the operator written notice that the SMS is consistent with:
 - the contractor's arrangements to manage the risks to health and safety from mining operations as per clause 9 of the WHSMPS Regulation, and
 - any other requirements under the WHS laws that relate to those operations.

(This option does not reduce the contractor's primary duty of care under WHS Act section 19.)

2.9.3 CONTRACTOR HEALTH AND SAFETY MANAGEMENT PLANS

If a contractor prepares a health and safety management plan it must:

- > be documented, and
- > set out how the contractor will manage risks to health and safety from its work carried out at the mine as per clause 9 of the WHSMPS Regulation, and
- > be designed to be used by the contractor as the primary means of ensuring, so far as is reasonably practicable, the health and safety of the contractor's workers and others at the mine, and
- > so far as is reasonably practicable, be set out and expressed in a way that is readily understandable by those who use it.

2.10 INCIDENT REPORTING, INVESTIGATION AND RECORD KEEPING

2.10.1 NOTIFICATIONS AND INVESTIGATION

The *Notification of incident and injury guide* provides more detailed information and guidance on the types of WHS incidents that must be notified.

There are six types of incidents that must be reported to the NSW Resources Regulator. These are:

- > the death of a person
- > a serious injury or illness
- > a dangerous incident, as defined in the regulations
- > an incident that results in injury or illness requiring medical treatment
- > a high potential incident
- > certain incidents relating to explosives.

NOTIFIABLE INCIDENT [WHSMP ACT SECTION 14]

A notifiable incident is:

- > the death of a person or
- > a serious injury or illness [WHSMP Regulation clause 178] or
- > a dangerous incident [WHSMP Regulation clause 179].

Notification must be given to the regulator if a notifiable incident occurs. You are required to:

- > immediately notify after becoming aware of the incident by the fastest possible means
- > preserve the incident site
- > if notification is by telephone, then written notification must be given within 48 hours of giving the notice by telephone.

OTHER INCIDENTS [WHSMP REGULATION CLAUSE 128]

An other incident is an incident that:

- > results in injury or illness requiring medical treatment [WHSMP Sch 9 Clause 13], or
- > is a high potential incident [WHSMP Reg 128(5)].

An other incident requires written notification to be given:

- > If the incident resulted in an injury or illness that required medical treatment, as soon as possible but within 48 hours, or
- > If the incident was a high potential incident, as soon as possible, but no later than seven days.

In both cases there is no requirement to preserve the incident site unless instructed otherwise.

Table 1. Incident types and reporting requirements

ANCILLARY REPORTS

Additional information – known as an ancillary report – must be submitted if there is a stipulated requirement to do so.

This report is required to be provided to the regulator no later than 30 days after the incident was required to be initially reported.



INCIDENTS WITH EXPLOSIVES

A licence holder under the *Explosives Act 2003* must immediately notify the Resources Regulator, NSW Police and SafeWork NSW of any incidents relating to explosives or explosive precursors that are:

- > lost, or
- > stolen, or
- > subjected to attempted theft, or
- > any suspicious activity that threatens the security of the explosives or explosive precursors.

A licence holder must also notify the regulator and SafeWork NSW of any serious incidents relating to the handling of explosives or explosive precursors. A serious incident is:

- > an uncontrolled explosion or fire, or
- > an incident resulting in the death of, or serious injury to, a person or substantial damage to property, or
- > any other incident involving risk of an uncontrolled explosion or fire or of any such death, injury or damage.

Where a serious incident has occurred, notice must be given as soon as practicable, and the scene must be preserved for a period of 36 hours after notice has been given, as follows:

- > an area within a radius of 4 metres of the place where the serious incident occurred, and
- > an area within a radius of 4 metres of a place affected by the serious incident.

(Note: Depending on type of incident notified to the regulator, the scene could result in preservation for a period longer than the 36 hours as required under the Explosives Regulation.)

REVIEW AFTER AN INCIDENT

The WHS laws require PCBUs to review control measures in certain circumstances including following an incident. This is because typically an incident has resulted from a control measure either not being implemented or not being effective in preventing the incident.

Incident investigations should identify controls to prevent the same or similar incidents reoccurring.

Under the WHSMPS Regulation, a mine operator or other PCBUs who review control measures following an incident must keep a record of the following matters:

- > the causes or likely causes of the incident
- > the work health and safety issues arising from the incident
- > recommendations arising from consideration of the incident including any recommendations directed at preventing a repeat of that type of incident
- > what the outcomes of the review are and any revisions to control measures or to the safety management system
- > a summary of changes to the safety management system (including any affected principal hazard management plan or principal control plan).

These records become part of the mine record.

THE MINE RECORD

The mine record is a record of specified documents that must be kept by the mine, and is readily available to workers. The record must contain:

- a. a record of any notice issued to the mine, being improvement notices, prohibition notices and non-disturbance notices; and

- b. a copy of any provisional improvement notice issued by a health and safety representative, and
- c. a record of every incident notified to the regulator, and
- d. a summary of all records of reviews of controls measures carried out by the mine operator or by other PCBU's, and
- e. each report made by an outgoing shift supervisor made for the incoming shift supervisor, and
- f. any other record that the operator is required to keep under the WHS laws, and
- g. a record of all first aid treatments provided at the mine.

2.10.2 OTHER NOTIFICATIONS

NOTIFICATION OF OTHER MATTERS, INCLUDING REPORTABLE EVENTS

Mining operations must notify the regulator of several matters [WHSMPRS Regulation clause 129], including:

- > the commencement or closure of the mine
- > any significant interruption to, or suspension of, mining activities at the mine
- > the recommencement of normal mining operations following any interruption or suspension
- > the connection of an electricity supply to the mine (but not if a person is nominated to exercise the statutory function of electrical engineer)
- > any proposed change to the details or competencies of the persons nominated to key statutory functions.

Notification must be given no later than one month before the event occurs except:

- > if the mine operator did not intend for the event to occur and could not have foreseen the event occurring. In this case, notice must be given as soon as practicable after the event occurs
- > if recommencing normal mining operations at the mine following significant interruption to, or suspension of, mining activities. In this case notice must be given as soon as is reasonably practicable after the mine operator becomes aware that the mining operations are to recommence.
- > if giving notice about changes to the details and competencies of nominated key statutory positions, the notification is to be given as soon as is reasonably practicable after becoming aware of the proposed changes.

Where a mine gives notice of commencement of mining operations, the following must be provided:

- a. the date of the commencement of mining operations, and
- b. the date that mining operations are intended to conclude, and
- c. the global positioning satellite coordinates of the area covered by the mine (and if the mining operations include exploration involving drilling, the coordinates of the location of the drill holes), and
- d. details of the scope, character and location of the mining operation, and
- e. details of the minerals sought, extracted or otherwise dealt with at the mine, and
- f. whether the mine is an underground mine, and
- g. identification details of the persons nominated to exercise key statutory functions and the competency of those people.

More details of the information to provide is included with the form *Notification of other matters (including reportable events)* on the Resources Regulator's website.

NOTIFICATION OF HIGH RISK ACTIVITIES

Mine operators of extractives and surface metalliferous operations must also notify the regulator of the following high-risk activity:

- > electrical work on energised electrical equipment (other than testing whether or not the equipment is energised).

You must wait seven days from the day the regulator received the completed notification before you can undertake the work, so ensure your notification is submitted so that it will be received by the regulator at least seven days before you plan to do the work.

You may apply for the regulator to reduce or waive the waiting period. This would normally be granted if the regulator has reviewed the notification and does not propose to take any action. Any reduction or waiving of the waiting period will be communicated in writing to you.

More details of the information to be provided is included with the form *Notifying the regulator of a high risk activity* on the Resources Regulator's website.

2.10.3 QUARTERLY REPORTING

Clause 130 of the WHSMPS Regulation requires the mine operator to give the regulator a quarterly work health and safety report. The report must provide the following information:

- > details of the mine operator, location of the mine and primary type of commodity processed
- > number of workers and hours worked, including overtime
- > total number of incidents, details of incidents and injuries, number of work days lost or restricted days lost
- > total number of medical treatments or deaths.

The reporting periods and time to submit the report are set out in the table below.

REPORTING PERIOD	SUBMISSION DEADLINE
September quarter 1 July - 30 September	No later than 31 January the following year
December quarter 1 October - 31 December	No later than 31 January the following year
March quarter 1 January - 31 March	No later than 31 July in that year
June quarter 1 April - 30 June	No later than 31 July in that year

Table 2. Reporting periods and submission deadlines

Quarterly reports should be submitted online, where possible.

If you have provided the regulator with an email address for the mine operator, you will be sent a unique link to a web form to complete your quarterly report. Reminders will be sent each quarter to help you submit your reports on time.



**PART
B**

This provides guidance for designing safety into mine and quarry operations. It describes in detail how to plan excavations, dumps, dams, roads and vehicle operating areas.

03

PART B

Planning for excavation

IN THIS SECTION:

- 3.1 Terminology**
- 3.2 Consideration of ground or strata failure principal hazard**
- 3.3 Ground or strata instability principal hazard management plan (PHMP)**
- 3.4 Geotechnical assessment**
- 3.5 Slope design**
- 3.6 Ground support and reinforcement systems**
- 3.7 Maintaining control over the excavation**

Planning for excavations requires a good understanding of ground conditions, and determining ways in which potential ground failure could be avoided. A systematic approach to managing ground instability is very important.

This section describes:

- > how to identify and manage hazards from unstable ground
- > the role of geotechnical assessments
- > how to design safe slopes
- > how to stabilise and support slopes.

The potential impacts of unplanned and uncontrolled ground movement are:

- > Safety – loss of life or injury to those working at or visiting the site.
- > Social – loss of income and workforce confidence and morale, minimised corporate credibility, and increased liability.
- > Financial and economic – disruptions to operations, product or equipment losses, increased stripping and clean-up costs, and reduced access to markets.
- > Environmental – collapse of, or damage to, nearby infrastructure, interference with natural drainage and damage to surrounding land, natural habitats, wildlife or conservation initiatives and programs. This can also prevent a site from meeting its rehabilitation requirements due to loss of benches.
- > Regulatory – unplanned failure of a slope occurs within close proximity of a terminal boundary, encroaching on areas outside of the approved area, therefore breaching approval conditions.

Safely developing a mine or quarry requires assessment of the deposit and the factors that will affect ground stability including:

- > the structure of the rock mass (i.e. folding, faulting, strike and dips)
- > rock strength
- > ground and surface water management
- > bench/batter configurations and slope height
- > seismicity and crustal stress
- > other geological characteristics.

A systematic approach to ground stability requires a good understanding of ground conditions before the operational phase. Slope designs should be suitable for the ground conditions and, where necessary, include the design and implementation of ground support or reinforcement. The ongoing maintenance of supports and continuous monitoring for any indication of movement or potential for failure are also important components of a systematic approach.

Refer to Section 7 for more information on controlling ground stability.

3.1 TERMINOLOGY

Slopes are generally designed as a series of batters separated by benches, which are provided at predefined vertical height intervals.

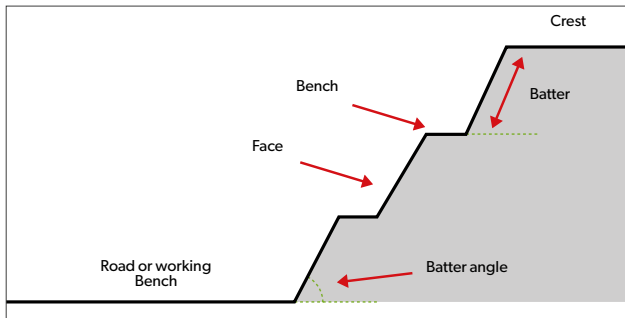

Figure 2. Slope design terminology

Access to an excavation can be by a road or ramp that may spiral around, or be located on one side of the excavation with switchbacks at each end. A succession of batters between two access ramp sections (or between a ramp section and the floor or crest) is defined as the inter-ramp slope. The inter-ramp slope angle is always flatter than the batter angle in that slope. The full height of a slope, from the toe to the crest, comprising several batters separated by benches (and access road sections if the road is on that slope) is the total slope angle (TSA) (see Figure 3).

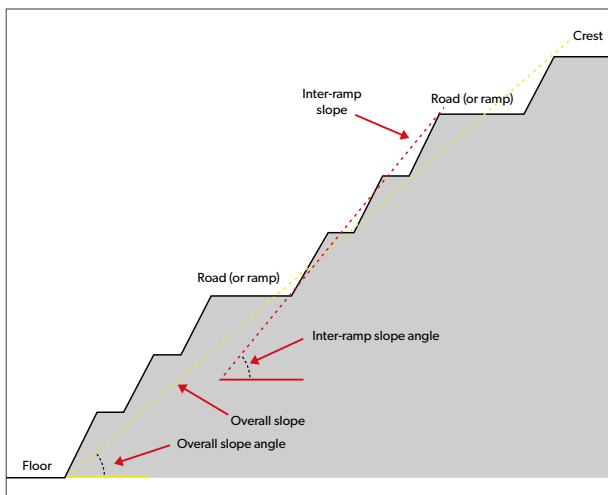

Figure 3. Slope design – inter-ramp and overall slope details

3.2 IDENTIFYING GROUND OR STRATA FAILURE PRINCIPAL HAZARD

Excavation faces and dams should be properly designed, with:

- > suitable slope angles
- > suitable bench widths and heights
- > benches with minimum widths. Typically, they are three times the width of the widest heavy mobile equipment (HME) for dual lane access and twice the width of the widest HME for single access benches (this depends on final pit design and TSA). The CSIRO Guideline for Open Pit Slope Design advises “0.2 x bench height + 4.5m”

- > face heights suitable for the site conditions and excavation method
- > faces that do not exceed the reach of the excavator. This reach can be extended by using the excavator on muck piles.
- > faces regularly scaled to control the risk of rock falls
- > faces, at quarries, and working benches in alluvial mines, that have not been undermined.

The mine operator must identify principal hazards at the mining operation (clause 24 WHSMPS)

Use competent people for technical input and advice during the consideration process, as required.

To determine if ground or strata failure is a principal hazard, consider how an excavation might feasibly fail, and the likely consequences of any such failure. The probability of such a failure happening is not relevant in the context of determining a principal hazard.

The consequences depend on the likely scale of the failure (i.e. the size of the failure and the area affected by it) and whether people are likely to be fatally injured.

You should consider whether a geotechnical assessment is needed.

As a guide:

- > Simple operations (e.g. shallow depth, soft material with faces less than 3.5 m, or competent rock with faces less than 15 m). A competent person should determine if the face design is safe, adequate benching is in place, or arrange for a geotechnical assessment. Assessments should be in writing, dated and signed with a review period established.
- > Complex operations (e.g. individual faces exceeding 15 m, overall excavation depth exceeding 30 m, fractured rock, disturbed geological structure) will require a geotechnical assessment by a competent person.

A geotechnical assessment should be completed where:

- > the height of any individual face is more than 15 m
- > in the case of 'soils and highly weathered or friable rock' where the height of any part of an excavation is more than 3.5 m and the overall slope angle is steeper than 2 horizontal to 1 vertical (27° to the horizontal) (see Figure 4)
- > the bottom of the excavation is more than 30 metres below any surrounding land within 30 metres of the edge of the excavation (i.e. the excavation is more than 30 metres deep, allowing for any nearby higher ground) (see Figure 5).

Irrespective of the excavation face height, depth or angle there are factors that mean there could be a principal hazard. An example could be fractured rock mass or geological discontinuities (poor rock mass quality) or the location or proximity of a dump.

In the case of 'unweathered high-strength rock', and well-cemented gravels, a geotechnical assessment should be carried out where the overall:

- height of any adequately benched slope, from toe to crest, is between 15 m–30 m
- total slope angle (TSA) is steeper than one horizontal to one vertical (45° to the horizontal) (see Figure 5).

The definition of soils and rocks of differing strength is provided in Table 3, after AS 1726-1993 *Geotechnical site investigations*.

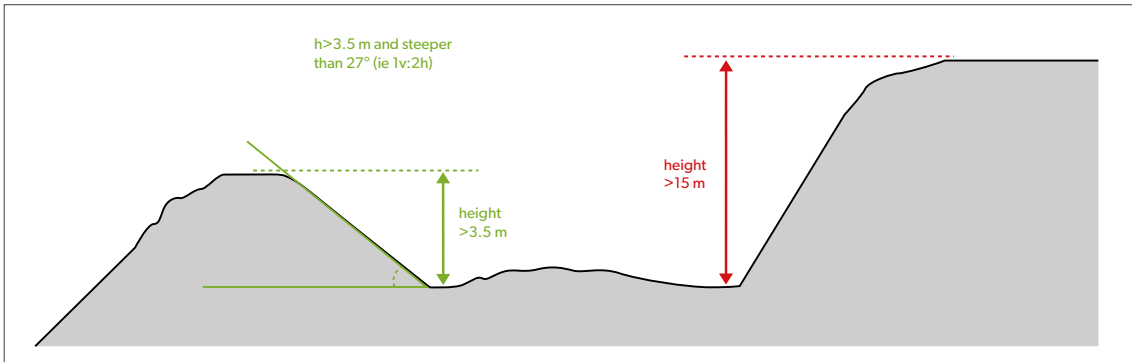

Figure 4. 'Soils and very weak rock' guidance

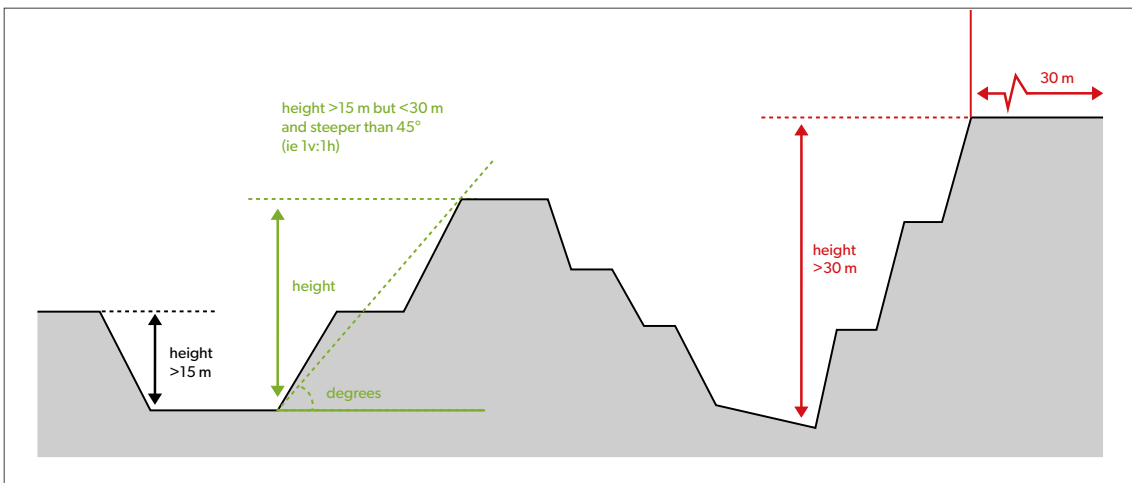

Figure 5. 'Stronger rock' guidance

FRACTION	COMPONENTS	SUBDIVISION	SIZE* MM
Oversize	Boulders		>200
	Cobbles		63 - 200
Coarse grained soil	Gravel	Coarse	19 - 63
		Medium	6.7 - 19
		Fine	2.36 - 6.7
	Sand	Coarse	0.6 - 2.36
		Medium	0.21 - 0.6
		Fine	0.075 - 0.21
Fine grained soil	Silt		0.002 - 0.075
	Clay		<0.002

Table 3. Definitions of soils and rocks of differing strength. Extract from AS 1726 Geotechnical site investigations.

Table 4 provides a list of typical issues that are commonly considered during a risk assessment or field investigation regarding actual, or the potential of, ground instability.

PARAMETER	CONSIDERATIONS
Slope type	Active or inactive
Slope geometry	Overall slope height, slope angle, bench height, bench slope angle, bench width
Engineering Characteristics	Rock or soil, structurally controlled, variable alteration or materials present, material or discontinuity shear strength parameters
Proximity of existing infrastructure	Property or services adjacent to both crest and toe of slope, both external and located on site
Proximity of workers	Vulnerability, location relative to potential failure
Proximity of general public	Proximity of public access, roads, footpaths, walkways and so on
Failure mechanism	Planar, wedge, toppling, rotational, liquefaction, toe bulge crest damage
Speed of failure	Rapid (flows, rockfall), slow (rotational), very slow (rotational)
Water (surface water and groundwater)	Visible signs of seepage or discharge, pore pressures behind high walls, prevention of detrimental effects by effective surface water management, and limiting uncontrolled
Recent history of failure	History of instability (type, location and so on), visible signs of active or previous failure (bulging of slope surfaces and so on)
Frequency and size of rockfall	The size of the rockfall and ejection or roll out distance (i.e. distance ejected off the batter and potentially down the slope)
Blast impacts	Blast performance and the damage induced into the rock mass (i.e. back break, crest damage)
Dispersive soils and clays	Common in western NSW where soils rapidly erode if left uncovered and batters are cut too steep.
Ground support technology	Shotcrete, rock bolting, soil nails, meshing or rockfall fences
Existing remedial measures	Reorientating the pit design, regrading, pumping (de-watering), re-profiling batters or benches, bunding, exclusion zones.
Monitoring	Extensometers, piezometers, closure meters, EDM targets, radar, (UAV) and Prism Survey
Seismic history	Whether the region is seismically active or subject to significant crustal stress
Operating parameters	Exposure time of workers (shift), excavation method, associated equipment (vehicle) exposure, effects of poor blasting

Table 4. Key issues for consideration in a risk assessment

3.3 GROUND OR STRATA FAILURE PRINCIPAL HAZARD MANAGEMENT PLAN (PHMP)

The mine operator must prepare a PHMP for each principal hazard associated with mining operations at the mine (clause 24 WHSMPS Regulation).

During the process of developing control measures for the risks associated with the principal hazard, the mine operator must consider the matters set out in schedule 1 of the WHSMPS Regulation. Schedule 1 requires the mine operator to consider the following when controlling ground and strata:

- > local geological structure, hydrogeological environment, effect of water and time on rock stability
- > blasting effects, dumps, stockpiles and emplacement areas, fill materials and filling requirements, appropriate equipment and procedures for monitoring, recording, interpreting and analysing data about seismic activity
- > suitable ground control methods, including appropriate design criteria (i.e. bench and batter heights).
- > appropriate equipment and procedures for monitoring, recording, interpreting and analysing data about seismic activity
- > collection, analysis and interpretation of relevant geotechnical data
- > use of appropriate equipment and procedures for scaling
- > how to maintain ground support integrity including replacement of defective supports
- > allowance for higher standards of support to be installed than that required by the PHMP.

The ground or strata instability PHMP should be developed in the context of the whole SMS and not in isolation. This will ensure gaps and overlaps are identified and used in implementing of suitable controls for ground or strata instability.

As is with all other PHMPs and PCPs, continual reviews and verification of the implementation of the controls is required to ensure that the plan is controlling the hazard.

For more detailed information on the content of the PHMP and its relationship with other management and controls plans, processes and procedures see the *Principal hazard management plans guide* and the *Code of practice - safety management systems in mines*.

3.4 GEOTECHNICAL ASSESSMENT

Where geotechnical assessments are identified as being needed, they should be carried out by a competent person. Geotechnical assessments of ground conditions are critical to developing a comprehensive PHMP. The data collected during the geotechnical assessment underpins:

- > slope design and its stability
- > the implementation of a suitable support system (where required)
- > recognition of geotechnical risk for relevant aspects of the operation
- > the ongoing monitoring requirements suitable to the size and scale of the design.

The geotechnical assessment should provide an indication of the risk and consequence of failure of relevant features. This may involve application of a factor of safety calculation but could include more extensive probability analysis. For more detailed information on factor of safety (FOS) and probability of failure (POF), see section 3.5.1.

The geotechnical assessment may include:

- > field data collection
- > formulation of a geotechnical model
- > slope design
- > pit design and orientation
- > design, control and monitoring of blasting
- > design, installation and quality control of rock support
- > design of suitable monitoring systems.

Factors that may be considered during the geotechnical assessment include:

- > possible seismic (either natural or induced) or geothermal activity
- > previously excavated or abandoned workings
- > subsidence or settlement (either controlled or through strain)
- > drainage patterns, groundwater regimes, water inflow and dewatering procedures
- > equipment and procedures used for scaling
- > effect of time and oxidation on rock support and stability
- > geotechnical design life requirements during and post extraction.

3.4.1 FIELD DATA COLLECTION

Field data collection is the process of obtaining relevant information that may affect the design, construction and performance of excavations.

The information collected is likely to include:

- > site history
- > up-to-date survey data and aerial images
- > topography and geomorphology
- > climate
- > hydrogeology and drainage
- > visually inspecting tension crack areas, voids (rat holes), areas of increased moisture ingress
- > physical geology and geologic structure petrology reports
- > lithology and rock mass properties.

Data collection should always be carried out by a competent person (i.e. a geologist, engineering geologist or geotechnical engineer) or a properly trained geotechnician under the supervision of an engineering geologist or geotechnical engineer.

3.4.2 FORMULATION OF A GEOTECHNICAL MODEL

The geotechnical assessment should address or include:

- > an assessment of the geological features of the deposit, including
 - the strength of the rock mass
 - hydrogeology

- the orientation of geological structure
- external influences.
- > the design of bench heights and bench widths, considering excavation methods and equipment, along with the potential for rockfall and rockfall ejection distances
- > optimal orientation of the quarry faces to increase stability and to improve fragmentation during blasting and excavation. This should include consideration of failure modes and how they should be managed.
- > an assessment of the suitability of the design for short and long-term stability and maintenance of the faces
- > an indication of risk and the associated factor of safety and probability of failure for the relevant sections of the excavation
- > the inspection and monitoring requirements.
- > the design must also allow adequate design for haul roads with provision for safety features as necessary, i.e.
 - suitable road widths, with
 - inner rock trap and berm,
 - outer edge protection (i.e. windrow)
 - other specific design features (i.e. lines of site cross cambering)
 - face edge stand-off

(Note: road grade will depend on types of vehicles used and OEM recommendations).

3.5 SLOPE DESIGN

At mines or quarries there is a tendency to increase the slope angle to decrease waste rock stripping and possibly generate higher return on an investment. However, increasing the slope angle decreases the stability of the slope, therefore increasing the geotechnical risk profile of the site.

This could lead to safety implications and higher operating costs due to slope failures. By applying sound geotechnical engineering practices, safe and stable slopes can be designed and maintained in almost any geological environment.

Varying parameters of bench height, bench width, batter face angle, inter-ramp slope height and total slope angle all contribute to improved overall slope stability. Examples of each are provided below.

3.5.1 SLOPE STABILITY ANALYSIS AND FACTOR OF SAFETY (FOS)

Fundamental to slope stability analysis is the anticipated modes of failure, the scale of the slope, available data and the perceived risk relevant to the particular stage of the slope.

Whether a particular failure is acceptable will depend on its associated consequence and risk. If the failure of a particular slope has no bearing on its surroundings or safety and production, it is likely to be of minimal concern. However, this is not generally the case. As such, slopes need to be designed to an acceptable standard considering the consequence of failure and the inherent uncertainty in the geotechnical model.

Slope design is essentially governed by two factors, the consequence of failure and the degree of inherent uncertainty.

It is usual practice to apply a FOS or POF to the design geometry. When the consequence of failure or the level of uncertainty is high, the design criteria should be altered accordingly (resulting in a more conservative design).

An example of the FOS and POF design criteria approach is shown in Table 5.

WALL CLASS	CONSEQUENCE OF FAILURE	DESIGN FOS	DESIGN POF	EXAMPLES
1	Moderately serious	1.2	10%	Highwalls not carrying major infrastructure
2	Serious	1.5	1%	Highwalls carrying major infrastructure (e.g. treatment plant, ROM pad, tailings structures, crushing structures)
3	Serious*	2.0	0.3%	Permanent highwalls near public infrastructure and adjoining leases

Table 5. Example of FOS and POF design criteria approach

* Where a mutually acceptable agreement to allow excavation cannot be made between the quarry or mine owner and the “owner” of the adjoining structure or plot of land. Note a higher standard of geotechnical data is required for the design of category 3 slopes compared to category 1 and 2 slopes

The mine should liaise with the geotechnical engineer to determine what technical reference material they use when determining the FOS and POS outcomes.

TYPES OF ANALYSIS

When developing stability analysis criteria, it is critical to understand the origins and limitations of the various geotechnical engineering design procedures when applying them. No matter how much data is accumulated, risks created by unanticipated conditions will generally remain to some degree.

Examples of analysis methods are:

- > rock mass rating (RMR) and mining rock mass rating (MRMR) classification systems
- > kinematic analysis of structurally controlled failures
- > limit equilibrium analysis
- > numerical analysis.

MODES OF FAILURE

Collecting and interpreting information on major structures and other geological features is important in determining failure potential.

Steeper and higher slopes or batters will generate greater driving forces. Developing steeper slopes reduces the factor of safety and increases the probability of rock mass failure, presenting a higher risk of slope failure. Slopes or batters excavated within rock masses that contain continuous, and persistent, geological structures have greater potential to develop large scale wall failures.

Control of large failures is generally more difficult and important than small failures. Potential large-scale failures are usually controlled with:

- > excavating slopes or batters to a shallower angle
- > depressurisation of groundwater in the rock mass
- > installing ground support and reinforcement.

Using ground support and reinforcement to control large scale failures is generally more expensive than when used for discontinuities with shorter trace lengths.

Basic modes of failure are listed below (Girard J.M. 2012).

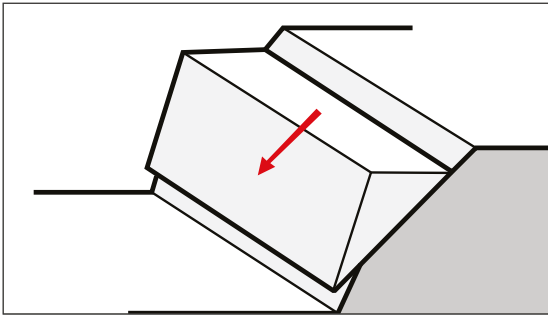

Figure 6. Planar failure

Planar failures occur when a geological discontinuity, such as a bedding plane, strikes parallel to the slope face and dips into the excavation at an angle steeper than the angle of friction.

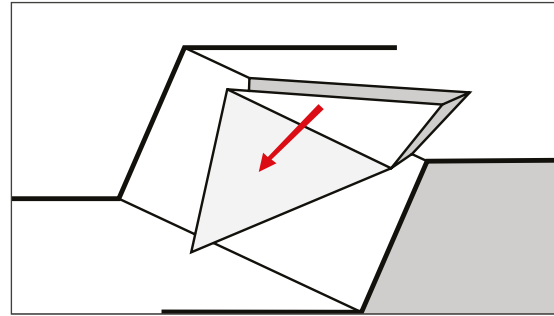

Figure 7. Wedge failure

Wedge failures occur when two discontinuities intersect and their line of intersection daylights in the face.

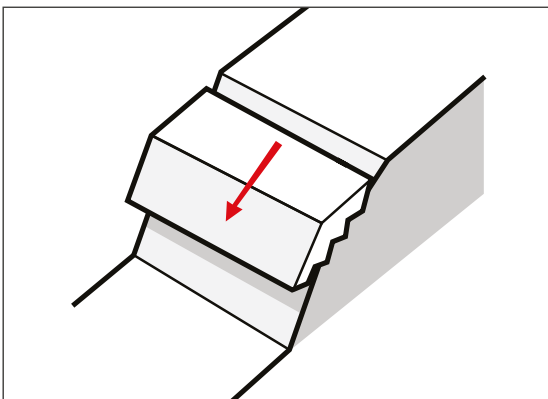

Figure 8. Step-path failure

Step-path failure is similar to planar failure, but the sliding is due to the combined mechanisms of multiple discontinuities or the tensile failure of the intact rock connecting members of the master joint set.

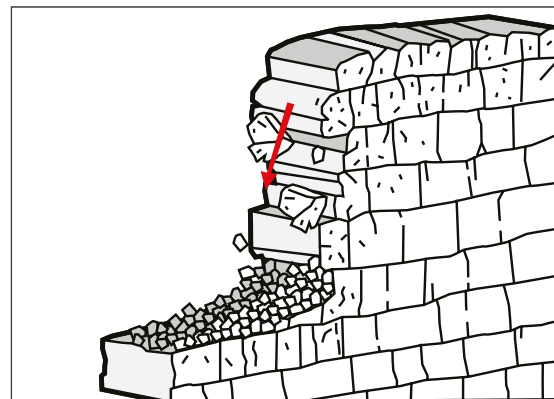

Figure 9. Ravelling failure

Ravelling is weathering of material and expansion and contraction associated with freeze-thaw cycles. This type of failure generally produces small rock falls, not massive failures.

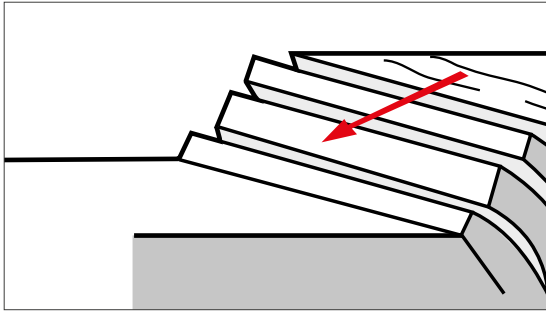

Figure 10. Toppling failure

Toppling can occur when vertical or near-vertical structures dip toward the pit. In this case, the bench face height should be limited to a distance roughly equal to the bench width. This will help catch any toppling material and decreases the chances of impacting work on the pit floor.

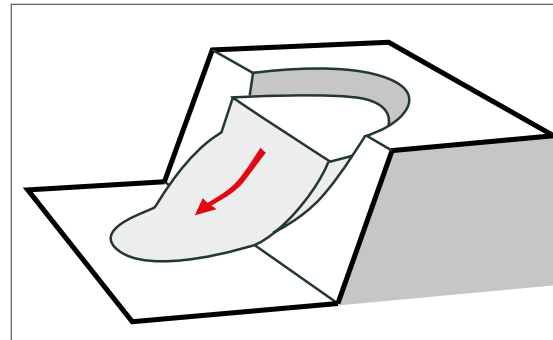

Figure 11. Circular failure

Circular failures (or slumps) generally occur in weak rock or soil slopes. They do not necessarily occur along a purely circular arc, but some form of curved failure surface is normally apparent. Failures can occur at the surface (slope failure), at the toe (toe failure), or at depth in a weak zone.

3.5.2 BATTER AND FINAL BENCH DESIGN

Slopes are generally designed as a series of batters separated by benches, at predefined height intervals.

Benches should be wide enough to stop potentially hazardous rock falls and contain any spills from the batters above.

The final decision on the maximum batter height should be based on:

- > geotechnical engineer's recommendations
- > reliability of the batter slope (i.e. stability under potential failure modes)
- > availability of equipment for adequate scaling to remove loose pieces of rock.

For reliability of the batter design, all possible failure modes should be identified and their stability assessed by kinematic and limit equilibrium analyses, as appropriate.

3.5.3 OVERALL SLOPE DESIGN

The methods of analysis required for overall slope design are the same as those used for the batter design, except the scale is different.

In stronger rocks, overall slopes may fail by planar and wedge sliding. In soils and weak rocks, they may fail by toppling and rotational shearing. More complex collapses involving failure through the rock mass will require analysis by various methods, such as numerical methods.

Batter stability immediately below and above the access ramp should also be considered when designing inter-ramp slopes. Batter instability immediately below could undermine the ramp and instability immediately above could spill onto the ramp.

3.5.4 WORKING BENCH WIDTHS

To determine working bench widths, consider the type of equipment and the method of mining or quarrying.

Ensure there is enough room to allow for the:

- > implementation of exclusion zones in areas of unsafe ground conditions that may occur
- > bench access to be a suitable distance from the batter face
- > excavating mobile plant to work
- > correct positioning of trucks being loaded
- > safe queuing of trucks while waiting to be loaded.

People should not be allowed to work near or under hazardous batters or benches. Unsafe ground conditions should be promptly actioned and remediated or treated as an exclusion zone. Exclusion zones on benches and the pit floor should also be established when workers are exposed to hazards, such as drill and blast crews.

3.5.5 GROUNDWATER AND SURFACE WATER CONTROL

Mines or quarries excavated below the groundwater table may need some form of dewatering and depressurisation. The most significant related problem is the effect that water pressure has on the stability of the slopes. Water pressure in structural defects in the rock mass, and pore spaces in rock material reduces effective stress, and consequently shear strength.

At some sites, with minor groundwater inflow from slopes or floor, evaporation alone can account for all dewatering requirements. At other sites, major pumping operations may be necessary. The approach to groundwater control can be by means of water abstraction methods such as:

- > production bores
- > sumps or trenches
- > sub-horizontal drainage holes drilled into the slopes.

Each method can be used individually or in combination to produce the required result. Selection of the most appropriate method will depend largely on the local and regional hydrogeological conditions, the relative importance of depressurisation to the specified design and the required rate of production. At large extractive sites, all three methods may be required for groundwater control. Production bores can be used in advance of and during extraction.

Control of surface drainage is also an important aspect of the implementation of the slope design. Surface water drainage paths through and around the site should be designed, constructed and maintained so that water does not dam at the crest or toe of critical slopes. To stop scouring on a face, water should not be discharged over a face except at controlled points. If possible, the water should be directed along the bench to the roadway, and along an open drain to a collection point, sump or settling dam. Surface water management is an aspect that requires consideration and input into the whole of mine site design.

(Note: In developing the controls for the PHMP on ground or strata control, there could be an impact on the PHMP for inundation or inrush of any substance, therefore careful consideration of risk controls needs to be done.)

3.6 GROUND SUPPORT AND REINFORCEMENT SYSTEMS

Several factors influence whether ground support is required. The basic principle of ground support and reinforcement is to allow the operator to maintain the same overall slope angle while retaining the overall factor of safety. This is important when addressing zones of weakness to maintain a consistent design shape. Safety is paramount, but economic viability and the various requirements based on operating type also influences design decisions.

Ground support and reinforcement systems (artificial support) may include retaining walls, placement of rock or cable bolts. It also may include structures such as drilled or cast in-situ piles, earth and rock anchors, reinforced earth including the use of geotextile and protection against erosion.

3.6.1 DESIGN CONSIDERATIONS

When providing artificial support, the design of the support system should be suitable for the specific ground conditions. Design methods for artificial support should consider:

- > the function of the support (e.g. to prevent rock fall, slope failure or rock slide)
- > geological structure in and around the slope
- > in situ rock mass strength and behaviour of the rock support or reinforcement system under load
- > groundwater regime and chemistry, rock stress levels and the changes in rock stress during the life of the excavation
- > the potential for seismic events (earthquake or blasting)
- > retaining the overall factor of safety.

Effect of timing of installation: Generally, the earlier artificial support is installed the more effective it is. In areas requiring support, installation should be undertaken as soon as practicable to limit potential loosening and unravelling of the rock mass. Extended delays in the installation may jeopardise effectiveness of the artificial support. Ideally, identified wedges or blocks that are potentially unstable should be secured as excavation continues, with artificial support being installed progressively.

Corrosion: The influence of corrosion means no conventional forms of artificial support will last indefinitely – they all have a finite design life. The use of galvanised components is one way in which the life of the support will be prolonged.

Quality control: Each element or layer of artificial support should be combined so that the overall system is well-matched to the ground conditions for the design life of the excavation.

You should develop a quality control procedure to ensure the standard of installation of artificial support meets the design expectations for all ground conditions at the site.

3.6.2 ARTIFICIAL SUPPORT MEASURES

Artificial support measures can be categorised into four main groups (Read and Stacey 2009):

- > rock bolting systems
- > retaining type structures
- > surface treatments
- > buttressing.

ROCK BOLTING SYSTEMS

Rock bolting systems typically fall into three categories: rock bolts, dowels (shear pins) and cable bolts. Rock bolting systems can be improved by connecting individual components by welded mesh or strapping.

RETAINING TYPE STRUCTURES

Retaining walls are typically formed from precast concrete or in situ poured concrete, steel sheet piling or bored piles. Walls can be reinforced or unreinforced and can be tied back with tendons into the rock.

Proper drainage behind the wall is critical to their performance. Drainage material will reduce or eliminate the hydraulic pressure and increase the stability of the fill material behind the wall.

SURFACE TREATMENTS

Shotcrete lining provides ground support and can lock key blocks into place. It also protects the rock against erosion by water and weathering. To protect water-sensitive ground, the shotcrete should be continuous and crack free and reinforced with a wire mesh or fibres.

Fibrecrete (steel fibre reinforced shotcrete) was introduced in the 1970s and has gained worldwide acceptance as a replacement for traditional wire mesh reinforced plain shotcrete. Steel fibres are incorporated in the shotcrete to improve its crack resistance, ductility, energy absorption and impact resistance characteristics. Properly designed, fibrecrete can reduce or eliminate cracking, a common problem in plain shotcrete.

Slope erosion protective measures – slopes that are highly susceptible to dispersion and erosion should be protected from trafficking along with rain and wind.

A rock or cobble cover of 300 mm thickness is usually sufficient to protect against wind and rain. Alternatively, grasses can be used.

Rock netting – linked steel wire and rings connected into sheets. Draped over a face, they limit rock movement and the energy in any movement. Useful in poor ground where fretting needs to be controlled.

Hydro-seeding – is a popular method of quickly establishing grasses on steep batters.

BUTRESSING

A simple method of increasing slope stability is to increase the weight of material at the toe, creating a counterforce that resists failure.

A berm or buttress of earth or rock can simply be dumped onto the toe of the slope. Broken rock or riprap is preferred to overburden because it has a greater frictional resistance to shear and is free draining, reducing problems with plugging groundwater flow. Shear trenches or shear keys provide increased shearing resistance to failure and also serve as a subsurface drain. A shear trench is frequently a good supplement to flattened slopes and berms. Shear trenches should extend the full length of the slope.

3.7 MAINTAINING CONTROL OVER THE EXCAVATION

The PHMP should have identified control actions that will be implemented to ensure that what has been planned is carried out. What this means is that a structured program of inspections should be put in place to check and verify that the ground and strata conditions where people are to work are safe and secure. This should include all relevant work places, with inspections done by operators, supervisors and managers. The system should have a process whereby the hierarchy of reports are reviewed by supervisors and managers.

The process should include inspections by external persons if the need is warranted.

Typical inspections can be pre-shift inspections by operators, supervisor's inspections throughout the shift, and end of shift/daily reports.



04

PART B

Planning for dumps, ponds, voids and dams

IN THIS SECTION:

- 4.1 Consideration of dumps, dams and voids as a principal hazard**
- 4.2 Dumps, dams or voids principal hazard management plan (PHMP)**
- 4.3 Planning and design criteria for dumps**
- 4.4 Planning and design criteria for dams**
- 4.5 Construction of a dump or dam**
- 4.6 Rehabilitation of dumps**
- 4.7 Maintaining control over dumps, dams and voids**

A well designed and constructed dump or dam will have the lowest long-term and operational risk (e.g. structural failure).

This section contains information on dams as well as dumps, overburden storage areas and other voids. This is because dams are often covered by a PHMP, particularly when they are large structures with a serious consequence of failure e.g. large overburden storage areas or tailings dams. This section describes:

- > how to identify and manage hazards from dumps, dams, and voids
- > the role of geotechnical assessments in ensuring stability in these structures
- > criteria for planning and designing dumps, dams, and voids
- > processes for constructing and maintaining safe dumps, dams, and voids.

The design of dumps, dams and overburden dumps should allow for:

- > keying the structure into competent foundation material
- > the natural slope and topography of the site
- > engineering properties of the material which will be constructed upon
- > seismic risk
- > the surrounding area drainage patterns, surface drainage and under-drainage patterns along with perched aquifers
- > size and lifespan
- > adjacent infrastructure and land ownership
- > final landscape and stability requirements
- > on site management and remediation of failures if practicable, and
- > equipment and operational methods to be used.

4.1 IDENTIFYING DUMPS, DAMS AND VOIDS AS A PRINCIPAL HAZARD

The mine operator must identify principal hazards at the mine. The most common principal hazards at mine sites have been specified in the WHSMPS Regulation, but there may be other hazards at the mine that have a reasonable potential to result in multiple deaths in a single incident or, a series of recurring incidents.

Therefore, dumps, dams and voids may be a principal hazard. Consider, for example, the consequences of the failure of a tailings dam or the collapse of a dump. Either have the potential to result in multiple fatalities if people are in the path of the failure and associated debris.

To determine if dumps, dams or voids are a principal hazard, you should consider how a dump, dam or void might feasibly fail, and the likely consequences of any such failure. The probability of such a failure happening is not relevant in the context of determining a principal hazard.

The consequences depend on:

- > the likely scale of the failure (i.e. the size of the failure and the area affected by it)
- > whether people are likely to be fatally injured.

If it has been determined that the dump, dam or void is a principal hazard, then a risk assessment must be undertaken. The risk assessment should use a competent person for technical input and advice during the assessment process.

Typically, a principal hazard exists where:

- > the dump is, or will be, in a wholly or mainly solid state and not in soft, weathered material (i.e. not likely to flow under wet conditions if not contained) and
 - the area of the dump is large

OR

- the height of the dump exceeds 15 m

OR

- the average gradient of the land covered by the dump exceeds 1 in 12.

- > the dump or dam contains, or will contain, any liquid or material wholly or mainly in solution or suspension (i.e. likely to flow if not contained) and

- the contents of the dump or dam is more than 4 m above the level of any land which is within 50 m of its perimeter,

OR

- irrespective of the size of the dump, dam or void, other factors (e.g. the geology, location or proximity to an excavation, occupied buildings etc.)

OR

- > vehicles operate near the edge of a dump, dam or void.
- > if a dump is or will be:
 - located on a slope
 - greater than 15 m high
 - contains sulphide or other waste materials that are harmful to the environment
 - constructed with soft, weathered material.

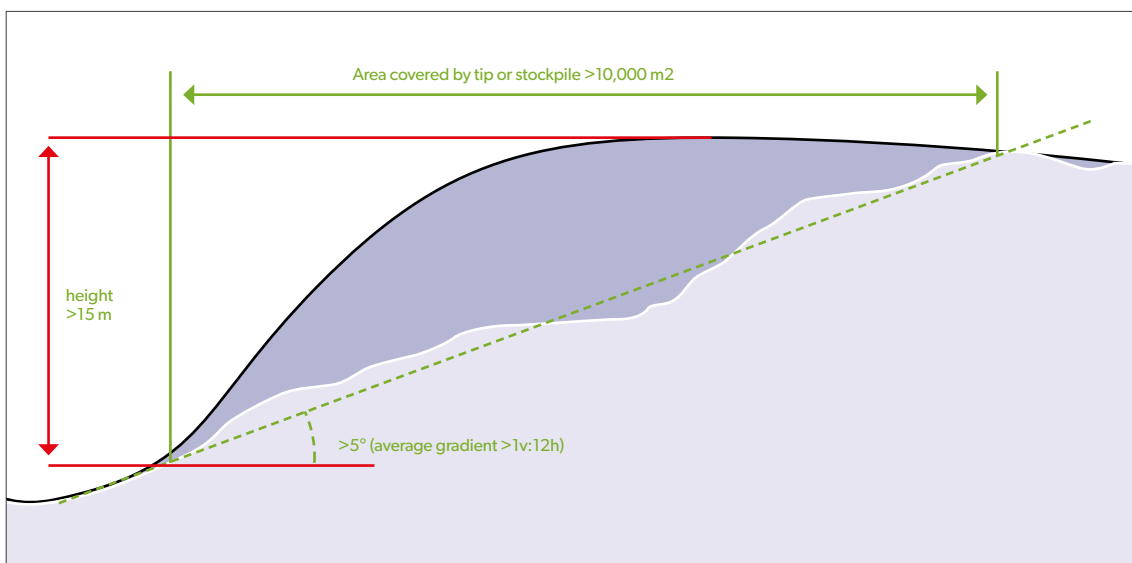

Figure 12. Guidance for tips (solid)

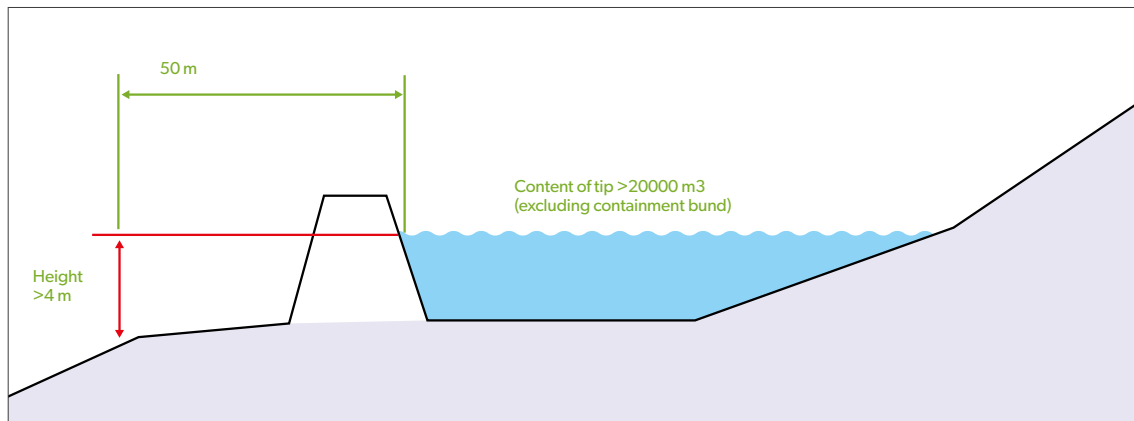

Figure 13. Guidance for tips (liquid) and ponds

4.2 PRINCIPAL HAZARD MANAGEMENT PLAN (PHMP)

The mine operator must prepare a PHMP for each principal hazard associated with mining operations at the mine (clause 24 WHSMPS Regulation).

When a PHMP is being prepared it must be based on a risk assessment. The risk control measures identified should consider procedures and processes for the safe design, construction and maintenance of dumps, dams or voids over the lifecycle of them, including:

- > a geotechnical assessment
- > road design and traffic movement
- > the dumping rules
- > records of material tipped
- > an inspection and monitoring regime.

As with all PHMPs, the WHSMPS Regulation clause 24 tells you what is needed in each plan.

Where regular inspections are identified as a control measure, the PHMP should also specify the nature and interval of inspections. It should also specify the appointment of a competent person to supervise the conduct of dumping operations, including a requirement that this person oversees the construction of a dump at the mine.

The dumps, dams and voids PHMP should be developed in the context of the whole health and safety management system and not in isolation. This will ensure gaps and overlaps are identified and used in the implementing of suitable controls.

For more detailed information on the content of the PHMP, and its relationship with other management and controls plans, processes and procedures, see the *Safety management systems in mines* code of practice.

4.2.1 GEOTECHNICAL ASSESSMENT

Where a dump, dam or void has been identified as a principal hazard, the PHMP should include a geotechnical assessment. This should be proportionate with the type and scale of the structure and associated operations and should consider:

- > the underlying geotechnical structure at the dump site



- > the properties of the material being tipped
- > the creation of any dams or voids.

A geotechnical assessment will dictate any foundation and surface treatment required and may include any or all of the following:

- > placement or removal of unsuitable, weak material in the foundation
- > benching of the foundation
- > installation of under-drains and final slope toe drains
- > installation of surface cut-off drains.

The data collected from the geotechnical assessment should lead to a geotechnical design that establishes appropriate foundations.

A geotechnical recommendation for the maximum lift height, depths, volumes and maximum overall dump height and type of material should be provided as part of the geotechnical design.

4.2.2 RECORDS TO BE KEPT

Where a dump or dam has been identified as a principal hazard, the PHMP should provide for record keeping of the materials being tipped if they are non-standard spoil materials (i.e. acid generating waste, super fines or other exotic or introduced materials).

4.3 PLANNING AND DESIGN CRITERIA FOR DUMPS

Dumping and storage of waste materials is a requirement for most operations. Storage design activities should be proactive and occur at the initial planning of the project, and not rely solely on reactionary and unoptimised design. You should be aware of the properties of the overburden, and the influence of the local environment, especially rainfall on dump stability.

To make sure health and safety hazards are controlled, consider:

- > the geological nature of the area (in particular the foundation of the dump)
- > the quantity, type, and rehabilitation of overburden
- > the type and size of the mobile plant to be used and access roads for vehicles and pedestrians
- > access to the area to reprofile batters, implement benches and to rehabilitate and remediate the structure as required
- > preparation of the receiving area
- > tipping methods and the dump construction methodology
- > settling requirements, drainage and runoff controls
- > stabilising methods, including inspections
- > controlling public access
- > any other hazards which may affect safety (e.g. overhead power lines).

Dumps should be designed to consider the full range of foundation materials, dump materials and ground and surface water conditions.

Prepare all dump sites to safely receive the material. This includes vegetation surveys, removal of vegetation and topsoil, and keying into the substrata to ensure the stability of the material placed above.

Where tree felling is required, competent workers with appropriate tree felling qualifications should be contracted to undertake the work.

Subsoil drainage should be considered, to ensure there can be no liquefaction of the material placed there. Subsoil drainage can be as simple as placing large rocks to allow moisture to wick through. However, this could be a more sophisticated system using drain coil and piping to capture and transport moisture through the material, to a controlled discharge below the dump.

All surface and sub surface water diversion and drainage structures should be designed and implemented according to acceptable engineering standards and be functional for the full life of the dump, and until fully remediated. Where rehabilitation is required, this work should be completed as soon as possible to prevent scouring and water damage through erosion.

Design access roads and other vehicle operating areas to acceptable engineering standards for the number and type of vehicles requiring access.

Design criteria should include road width, road gradient, edge protection, signs, speed limits, lighting, overhead hazards and passing rules. Refer to section 5 for further information on roads.

Adjacent stockpiles can influence each other (e.g. stability may be altered where they overlap). The adequacy of vehicle routes should also be considered when planning the position and size of stockpiles. In particular, the risk of collision can be minimised by ensuring a clear field of view for drivers (refer section 11.9.4).

As part of planning you should include appropriate edge protection (refer sections 5.3.9 and 8.2.3).

4.4 PLANNING AND DESIGN CRITERIA FOR DUMPS, PONDS OR DAMS

The site for a dam (or tailings dam) must be selected to eliminate hazards or minimise the potential impact on people. This includes during operations, decommissioning and after abandonment, particularly in the event of the following:

- > unexpected inflow events
- > climate change
- > seismicity
- > elevation in the groundwater table
- > seepage
- > dust generation
- > exposure to chemicals or hazardous particulates
- > erosion
- > overtopping
- > abrupt failure of retaining structure
- > impediment of surface water flows
- > pollution
- > noise.

Physical factors that should be considered during site selection and design include:

- > hydrology (potential for flooding and catchment area characteristics)
- > topography (influence of watershed, streams and creek systems)

- > foundation material (water tightness, strength and liquefaction potential)
- > foundation conditions (physical, geochemical and geotechnical properties)
- > characteristics of construction (stability, availability and proximity)
- > characteristics of tailings material (physical, geochemical and geotechnical properties)
- > climate (rainfall patterns, evaporation rates and prevailing winds)
- > geology (faults, fractures, shear zones and areas of instability)
- > hydrogeology (potential impact on ground water resources)
- > seismicity
- > minimum freeboard
- > seepage control methods
- > characteristics of embankment or other retaining structures (stability, erosion resistance, resistance to dynamic or static liquefaction and integrated waste landform)
- > operating strategy
- > requirement for access
- > requirement for discharge of water and required water quality
- > treatment of discharged waters
- > characteristics and availability of cover and rehabilitation methods
- > whether there are any populated areas downstream that may be adversely affected in the event of a failure
- > overflow strategy incorporating catchment ponds for sediment retention

Site abandonment should be considered during the design stage to ensure post-abandonment performance will meet stakeholder expectations and regulatory requirements. Abandonment and rehabilitation planning should ensure the dam disposal area is left such that it is able to:

- > maintain an acceptable level of hazard controls (e.g. for dust control, access, and so on)
- > remain structurally stable
- > resist deterioration through erosion and decay
- > suitably limit any negative environmental impacts
- > prevent the loss of contaminants.

4.5 CONSTRUCTION OF A DUMP OR DAM

You should develop and implement a construction plan to ensure the dump or dam construction meets relevant design specifications and tolerances. This should include quality assurance procedures. The plan should also contain systems of work and procedures to ensure the proposed construction can be carried out safely.

Use a competent person to ensure that construction of dumps or dams meet design specifications and tolerances, and that the following are documented:

- > the conditions encountered during construction (including field and laboratory testing). This should be verified against those assumed in the design
- > corrective measures taken where conditions did not meet the original design or specifications
- > all changes required that deviated from the original design
- > the testing and measurement regime to validate the design parameters
- > survey data and drawings of the dump or dam construction.

The true locations of the following features should be shown in your design:

- > borrow pits and embankments
- > drains and seeping trenches
- > topsoil stockpiles and capping material sources
- > process water and return water dams
- > monitoring instrumentation
- > decant towers
- > buried pipework and cables.

The construction records and monitoring data form the basis of the design of subsequent stages. Where construction is staged, a separate construction report should be prepared for each stage.

Your dump or dam may also be considered a declared dam under the Dams Safety Act 2015. You can view the Dams Safety Act 2015 at www.legislation.nsw.gov.au.

4.5.1 DRAINAGE OF A DUMP

If sufficient water is present, either from heavy rainfall or other sources, some or all of a dump can become saturated. In this case, the water in the saturated portion has a buoyant effect and reduces the strength of the material, making the dump more prone to sliding. As such, measures should be taken to ensure water drains away. Water should never be allowed to accumulate against or on any part of the dump, unless it is specifically designed as a pond or dam.

Where dumps are constructed above an existing water course, the water course should be diverted or culverts of sufficient size provided to channel the water through the dump area. The dump should have internal drainage to deal with expected rainfall. This is usually provided by under-dump drains or coarse, permeable layers positioned at appropriate levels. Internal drainage systems should be designed by a suitably competent engineer or hydrologist. Drainage systems must be maintained.

4.5.2 DAM SAFETY SCHEME

Declared dams must comply with the requirements of a dam, as set out in Dam Safety Act 2015. Structures at extractives sites that may be declared dams include settling dams, tailing dams and reservoirs.

For more detailed information on dam notifications, dam classification, dam safety assurance programmes or dam compliance certificates see www.damsafety.nsw.gov.au. Additionally, the ANCOLD Guidelines also provide relevant information on dam design and safety.¹

4.5.3 SMALL DAMS

Dams should be designed, built and maintained to an appropriate standard. Substandard dams can fail, causing injury to workers as well as damage to equipment and financial loss.

For further general information on inspecting or constructing small to large dams refer to:

- Australian National Committee on Large Dams: the “ANCOLD Guidelines”.
- *Soils, Their Properties and Management* Oxford Press Charman and Murphy (especially useful for small dams)

¹ Australian National Committee on Large Dams the ANCOLD Guidelines

- IECA Australasia International Council on Erosion and Sediment Control.
- While for small dams, the Department of Primary Industries provides useful information at: www.dpi.nsw.gov.au/water/irrigation/storage/services/building-a-farm-dam

CONSTRUCTION OF A SMALL DAM

The construction of a small dam may or may not require building consent, however it does require careful consideration of design and construction methodology. In the first instance, a technical expert should be engaged to provide advice on designing and constructing a small dam to make sure it is fit for purpose and it complies with the relevant legislation.

A small dam is expected to have the following features:

Foundations and structural support

The areas of ground on which the dam is located (including the areas of adjacent ground) form part of the total water barrier. If the foundations do not adequately support the basic small dam structure, or are weak or prone to high seepage flows, they can cause the dam to become useless or to fail. The foundation of a small dam is often the natural materials on which it stands. A clean, stable foundation of adequate strength and low permeability is vital for a small dam's durability and performance. An adequate seal at the dam foundation and abutments must be formed to reduce leakage from the reservoir. Otherwise, it may not fill or excessive seepage may cause dam failure.

Spillway and high stream flow prevention

Dams require at least one working spillway or other water release mechanism. A flood spillway prevents high stream flows caused by heavy or prolonged downpours from overtopping the dam crest. Uncontrolled overtopping can cause erosion of the dam materials, and may lead to a breach of the dam. The flood spillway is normally formed around the end of the small dam and extends downstream, clear of the dam toe. It is generally impervious to limit ingress of water into the dam's outer wall. The flood spillway must be of a size adequate for flood flows expected for the rainfall and catchment size or topography. A smaller service spillway for a small dam may also exist and will normally be a culvert or pipe that takes normal flows, or could have a water drop box and boards to regulate freeboard to overflow.

Storage capacity

Assess the volume of storage to ensure it is large enough for the intended purpose. Sufficient freeboard must be provided to prevent overtopping of the dam.

Embankment and slope angles

The embankment must have a crest of sufficient width and may require protection if vehicles or heavy stock will have access. The upstream and downstream slope angles need to be chosen carefully, to ensure the embankment slopes are stable. To ensure a high standard of compaction, the fill material needs to be carefully selected, sufficiently impervious, and placed at the correct moisture level and thickness of each layer. Riprap may be required on the upstream face to protect the dam against wave lap erosion, and on the downstream batters to prevent erosion, dispersion and scour of the outer batter.

Pipes and conduits

Pipes are often placed through the bottom of the dam for drawing of water. However, it is important to note these can also be weak points for seepage, causing erosion of the dam fill. Technical advice is recommended for correct design details where pipes pass through a dam.

4.6 REHABILITATION OF DUMPS

When the site is temporarily, (suspended), or permanently closed, (abandoned), it must be left in a safe condition.

Typically, rehabilitation is carried out progressively, meaning parts of the site can be abandoned, while other parts are still operational (e.g. rehabilitation of overburden dumps that have reached capacity).

The objectives of abandonment of all or part of a site are:

- > to ensure the public is safe by preventing inadvertent access to site infrastructure
- > to provide for the stable, long-term storage of overburden and tailings
- > to make sure the site is self-sustaining and prevent or minimise environmental impacts
- > to rehabilitate disturbed areas for a land use (e.g. return of disturbed areas to a natural state or other acceptable land use).

Rehabilitation should address management of water runoff, air quality, stability of material, erosion control and treatment and containment of any possible hazardous substances.

Stability of material and control of water runoff are critical as they will be the first indicators of any problems in the rehabilitated area. Stability should be monitored by examining the toe, batters and crest area of any overburden dump. The toe batters and crest should be well compacted and not bulging or moving out from its original placement. Another indicator of movement would be cracks (tension gashes), appearing around the crest or top of the rehabilitated dump, which can indicate settling or potentially larger scale failures.

Rehabilitation is a requirement for all new resource consents and most existing resource consents. Rehabilitation should be considered and incorporated into all aspects of site planning, construction and operation. This allows key aspects of the abandonment to be planned for throughout the site's life cycle. Plans should identify measures to be undertaken during the operations phase that are aimed at progressive rehabilitation of disturbed or developed areas of the site.

Review and revise rehabilitation plans as necessary throughout the site's life cycle. The plans may become more detailed, incorporating more activities related to the site and consideration of more site conditions and monitoring results.

4.7 MAINTAINING CONTROL OVER DUMPS, DAMS AND VOIDS

The PHMP should have identified control actions that will be implemented to ensure that what has been planned is carried out. This means a structured program of inspections should be put in place to check and verify that the dumps, dams and voids where people are to work are safe and secure. This should include all aspects of the dumps, dams and voids being inspected on a regular basis by competent people. The system should have a process whereby the hierarchy of reports are reviewed by supervisors and managers.

The process should include inspections by external people if the need is warranted.





05

PART **B**

Planning for roads and vehicle operating areas

IN THIS SECTION:

- 5.1 Consideration of roads and other vehicle operating areas**
- 5.2 Roads and other vehicle operating areas principal hazard management plan**
- 5.3 Design and layout of roads**
- 5.4 Maintaining control over roads and other vehicle operating areas**

Roads and other vehicle operating areas can introduce significant hazards at an extractive site. However, a well-designed and maintained site will make workplace vehicle accidents less likely.

This section describes how to:

- > identify and manage hazards from roads and other vehicle operating areas
- > plan and design safe vehicle routes, road structures, gradients, corners, drainage, surfacing, visibility and areas for working, turning, and stopping
- > design cost effective maintenance requirements
- > achieve best overall operating standards
- > manage traffic and provide clear information and guidance for drivers.

The overall message is **safety by design**.

Considering what vehicle activities will be conducted on a road or other vehicle operating areas will help determine the kind of hazards that may be present. The unwanted events associated with roads and other vehicle operating areas include:

- > vehicles rolling over or going over edges
- > ground failure on to or below vehicles
- > collisions between vehicles and unwanted interaction between vehicles and people
- > uncontrolled movement of vehicles
- > vehicles making contact with overhead power lines or other structures.

Assessing the risks will help you take the correct action to eliminate, isolate or minimise hazards.

5.1 IDENTIFYING ROADS AND OTHER VEHICLE OPERATING AREAS

The mine operator must identify all principal hazards associated with mining operations at the mine (clause 23 WHSMPS Regulation)

To determine if roads and other vehicle operating areas are a principal hazard, consider the following factors to decide if they can result in multiple deaths in a single incident, or can cause a series of recurring incidents. (Note: the probability of such an event actually happening is not relevant in determining if it is a principal hazard.)

- > How a road or other vehicle operating area might feasibly fail and the likely consequences of a failure (e.g. collapse, slips).
- > The type of vehicles using the road or other vehicle operating area.
- > The activities that are undertaken and the consequence of any interactions between vehicles and pedestrians, structures or other vehicles. For example:
 - vehicles carrying passengers
 - light and heavy vehicle interactions

- travelling under overhead power lines
- loading over a cab where a driver may be present etc.
- > How a vehicle may lose control and the likely consequences (e.g. driver falling asleep, mechanical failure, dump over).
- > The hazards on the road or other vehicle operating area (e.g. sharp corners, steep gradients, large drop-offs etc.)
- > Any other hazard involving vehicles.

Use competent people for technical input and advice when considering whether the principal hazard exists as required.

A comprehensive and systematic risk assessment must be completed for the roads and other vehicle operating areas principal hazard. You must consider the principal hazard individually and also cumulatively with other hazards at the mine, for example, consider the impact of mechanical failure of mobile plant that uses roadways.

You must include the risk assessment in the *Roads and other vehicle operating areas* PHMP.

5.2 ROADS AND OTHER VEHICLE OPERATING AREAS PRINCIPAL HAZARD MANAGEMENT PLAN

The mine operator must prepare a PHMP for each principal hazard associated with mining operations at the mine (clause 24 WHSMPS Regulation).

As with all PHMPs, the WHSMPS Regulation clause 24 tells you what is needed in each plan.

When a PHMP is being prepared it must be based on a risk assessment. When developing the controls in the risk assessment, the matters set out in schedule 1 of the WHSMPS Regulation are to be considered. Summarising some of these matters, this means you must consider each of the following matters when developing control measures:

- > the characteristics of mobile plant including stopping distances, manoeuvrability, operating speeds, driver position, driver line of sight and remote control mobile plant
- > the effect on road conditions of expected environmental conditions during operating periods (including time of day, weather, temperature and visibility)(e.g. rain, ice, fog)
- > the impact of road design including grade, camber, surface, radius of curves and intersections
- > the impact of mine design, including banks and steep drops adjacent to vehicle operating areas
- > the volume and speed of traffic and the potential for interactions between mobile plant with different operating characteristics, including heavy and light vehicles
- > the potential for interactions between mobile plant and pedestrians, including consideration of park-up areas and driver access
- > the potential for interaction between mobile plant and public traffic
- > the potential for interaction between mobile plant and fixed structures (e.g. gas pipes and processing machinery), including overhead and underground power lines.

Measures to control risks associated with roads and other vehicle operating areas include:

General road design:

- > controls for the safe design, layout, operation, construction and maintenance of roads and other vehicle operating areas

- > road maximum grade, minimum widths and radius for curves, camber, surface material specifications and drainage needs.

In relation to dump trucks:

- > the design, construction, and maintenance of safety benches, windrows and collision bunds
- > measures to manage the risks of trucks overturning or running out of control
- > safe dump areas and routes
- > recommended methods of safe working.

Procedures for the operation and movement of loads:

- > shifting equipment and discharging loads
- > the maximum loads that can be carried or towed.

Worker safety:

- > how workers will safely access and exit their place of work
- > how workers will safely work or travel on or near roads or other vehicle operating areas
- > areas to be considered prohibited zones.

Vehicle safety and maintenance:

- > park-up, refuelling and recharging safety requirements
- > parking at worker amenity areas and office facilities
- > the safe storage and dispensing of fuel
- > the periodic inspection and testing of the braking system
- > the safe operation and requirements of vehicles carrying passengers or transporting equipment including separation of loads, the use of seat belts or other restraint devices and the provision of seating
- > how defects identified when inspecting vehicles will be addressed.

The roads and other vehicle operating areas PHMP should be developed as a part of the whole safety management system, and not in isolation. This will ensure that gaps and overlaps are identified, and controls can be developed that cover the whole aspect of roads and other vehicle operating areas.

In particular, there will be some links between roads and other vehicle operating areas PHMP and the mechanical engineering control plan.

5.3 DESIGN AND LAYOUT OF ROADS

Every site is different and likely to present different hazards and risks. However, a well-designed and maintained site with suitable separation of vehicles and people will make vehicle accidents less likely.

Safe workplaces are achieved by separating pedestrians and vehicles, light and heavy vehicles, and providing hazard-free vehicle routes.

5.3.1 TERRAIN AND GEOTECHNICAL CONSIDERATIONS

Consider the terrain and geotechnical issues when designing and establishing roads. They will impact on the type of operation that will be carried out, the mobile equipment to be used, and where infrastructure can be located.

5.3.2 OPERATIONAL PARAMETERS

Consider how operating parameters will impact on the design, layout, and materials used to construct the road and maintenance requirements before constructing and establishing roads. This includes:

- > vehicle manufacturers' recommendations for use of each vehicle
- > the nature, type and load of vehicles that will use the road
- > expected volume of traffic
- > operating hours
- > vehicle operating speeds
- > gradients (including superelevation)
- > road drainage
- > materials available for road construction and maintenance.

5.3.3 VEHICLE ROUTES

Where practicable, you must eliminate the hazard of pedestrians and vehicles interacting. The most effective way of achieving this is to provide separate pedestrian and vehicle routes, and where practicable, separating light and heavy vehicles.

Design roads that are:

- > adequate for the number, type and size of the largest vehicles that may use them
- > suitable for the varying driver positions which includes height and cab position (e.g. right, left or centre drivers position).
- > larger vehicles will require more detailed systems and processes.

Roads should:

- > be constructed with suitable material to provide firm surfaces, adequate drainage and safe profiles to allow safe vehicle movements
- > be clearly signposted including speed limits and UHF call notifications
- > where appropriate, have edge protection and road markings (e.g. sealed roads) or delineators showing the right of way
- > have speed limits and speed control measures specific to site conditions and the types of vehicles using the route
- > have adequate rock fall protection measures (e.g. a catch ditch, catch bench or suitable barrier)
- > be clearly delineated in the hours of darkness by using lighting, reflective marker pegs or similar devices or have suitable access restrictions to hazards (e.g. ponds or other water filled hazards or steep drop-offs)
- > allow for back break of the bench crest during the life of the road. The amount of back break will depend on geotechnical characteristics of the bench
- > minimise the need for reversing with one-way systems and turning points
- > accommodate the turning circles of vehicles.

Also consider:

- > access to the site including weight restrictions on bridges and narrow roads
- > height limitations for traversing under overhead structures
- > where distribution points will be (e.g. processing areas, weighbridge location, workshop access, load covering areas, loading areas, points of sale to the public)
- > impacts of land adjacent to the road.

Where practicable, road design should avoid:

- > office facilities and light vehicle parking areas
- > unstable areas
- > hazards such as excavations, ponds, structures, fuel or chemical storage areas, underground workings or voids and overhead power lines
- > steep gradients and tight bends
- > one-lane two-way routes.

You may need to engage a specialist traffic engineer for complex traffic flows, especially at sites with large processing operations.

5.3.4 ROAD WIDTHS

The width of a road should be based on the size of the largest vehicle in use. The larger the vehicle, the more clearance is required.

Each lane of travel should be at least one-and-a-half times the width of the widest vehicle that would normally use the road. For a two-lane road, the width should be at least three times the width of the largest vehicle. Provide extra room for drains, windrows or centre windrows (refer to Figure 14).

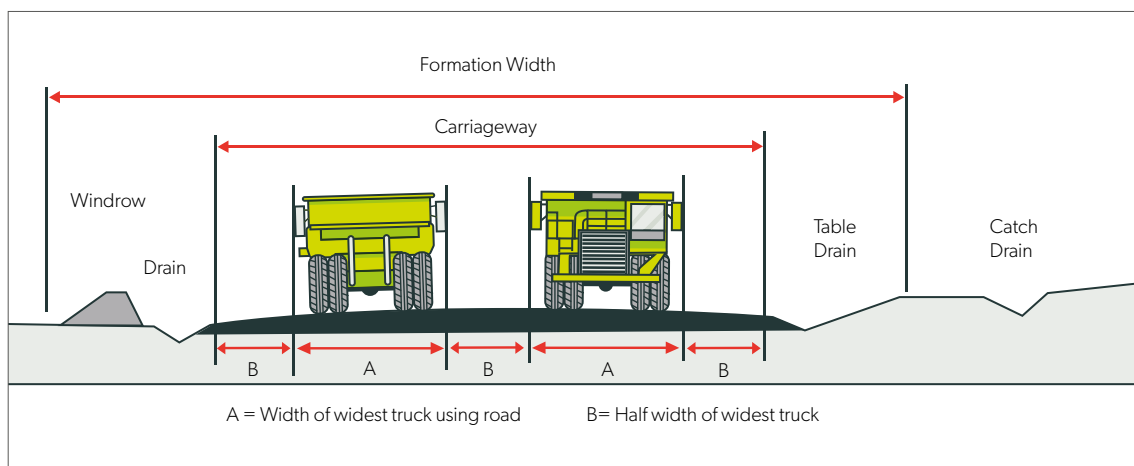

Figure 14. Example road layout with clearance between lanes

Where it is not practicable to have two lane roads, adequate passing bays and turning points should be provided. One-lane roads and turning points are not recommended on haul roads.

It may be appropriate to use turning bays to allow vehicles to turn and drive forwards for most of the time. Turning bays would ideally be a roundabout or a 'banjo' type. Although, 'hammerhead' and 'stub' arrangements may be acceptable.

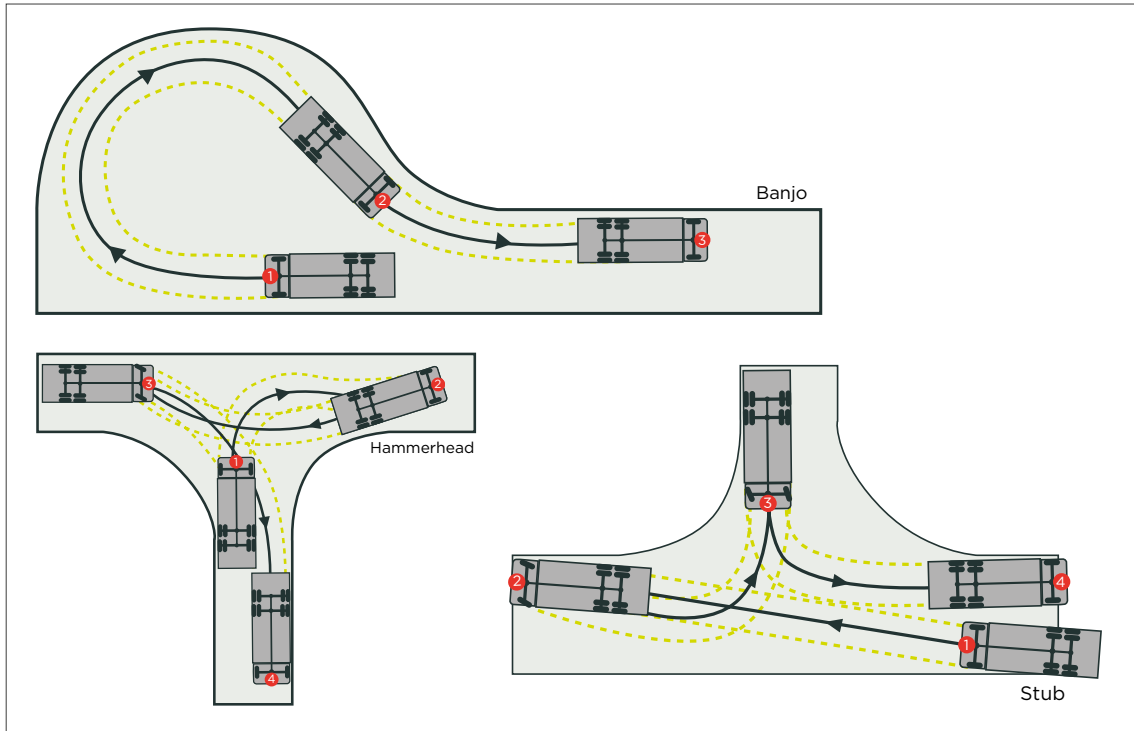

Figure 15. Turning arrangements

Where reasonably practicable, provide segregation of light vehicles on roads that are also used by off road dump trucks. This is to eliminate interactions between light and heavy vehicles (refer Figure 16).

The hierarchy of controls for controlling light and heavy vehicle interactions is:

1. Separation (different haul road).
2. Segregation (bund separation on same haul road).
3. Administrative controls e.g. traffic lights or boom gates etc.

Consider the interactions of light and heavy vehicles when entering and leaving haul roads.

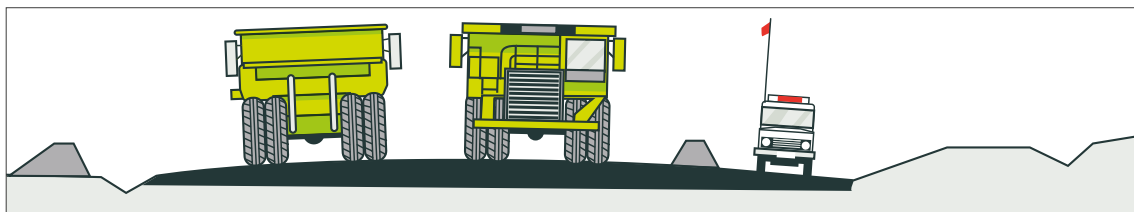

Figure 16. Segregation of light vehicles



Bends on haul roads should be designed wider than the straight stretch to allow for overhang of vehicles using it. Switchbacks or other areas on haul roads requiring sharp curves should be designed to take into account the minimum turning radius of the haul trucks.

5.3.5 ROAD GRADIENT

Important aspects of the steepness or grade of a roadway are:

- > the grade needs to be compatible with the braking capabilities of the vehicles (with a factor of safety)
- > the grade needs to be compatible with the performance capabilities of the vehicles
- > the grade will affect a vehicle's stopping distance
- > the grade selected will have to consider a vehicle's ability to operate safely in wet conditions
- > superelevation affects the speed around bends.

All the aspects should be checked for each different vehicle's original equipment manufacturer's (OEM) recommendations.

DETERMINING THE GRADE OF A ROAD

The steepness of a road is normally expressed as a ratio. The ratio is determined by measuring the distance travelled along the road in relation to the vertical height change (see Figure 17). For example, a road with a 1 metre vertical change over a travelling distance of 10 metres is a 1:10 ratio.

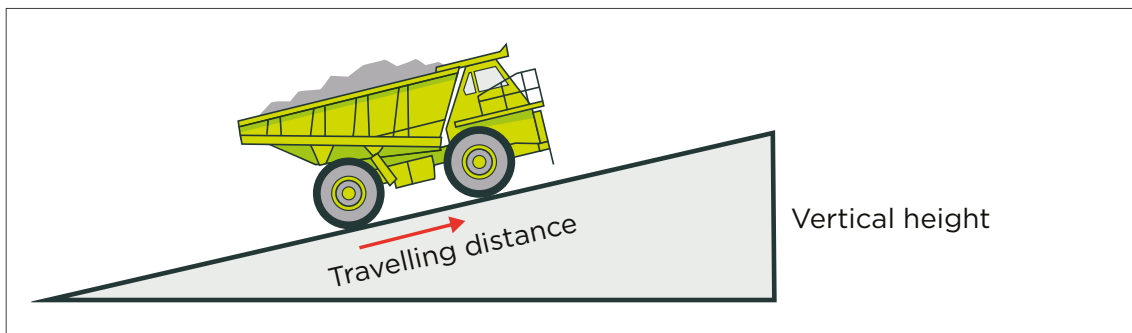

Figure 17. Road gradient

Information in vehicle manuals about braking and performance abilities on slopes may be provided as a grade percentage. This will need to be converted to ratio (e.g. 5% slope = 1:20; 10% slope = 1:10).

The steepness of a road should be measured using surveying equipment. The grade should be determined over a portion of the road where the grade is constant. Where the steepness varies, the grades should be determined for different segments.

GRADE AND VEHICLE COMPATIBILITY

The grade of a road must be compatible with road conditions, the type of road surface and the vehicle capability. Vehicle brakes must be able to stop in the worst-case scenario without losing control of the vehicle. Particular attention should be paid when loads are moved downhill.

Different vehicles, with different performance characteristics, will use the roads. Design the roads to allow all

vehicles to operate within their safety parameters. Road grades should never be designed to the maximum climbing or descending capacity of the vehicles that use them. Generally, a gradient of 1:10 or less should be applied when planning long term haul road layouts.

It is important vehicles are not overloaded as brake or retarder performances depend on the grade and on the vehicle’s total weight (refer 11.4.3).

GRADE SITUATIONS TO AVOID

Avoid road alignments that result in a sharp bend near the top of a grade. These are hard to see at night, when headlights tend to shine up into the darkness. If this cannot be avoided, the bend should be defined, for example, using extended reflective markers.

Also avoid sharp bends near the bottom of a grade. Here, vehicles tend to pick up momentum, making it more difficult to maintain control around the bend. If you cannot avoid a sharp bend, a safe speed for descending the grade should be posted as well as adequate restraining measures, such as large windrows or runaway provisions should be used (refer 5.3.9 and 5.3.10).

SUPERELEVATION

Superelevation is a technique used to assist vehicles in manoeuvring safely around corners and assists with road surface drainage. Superelevation is the banking of the road pavement at bends. It allows the vehicle taking the corner to counteract forces towards the outside of the bend, by directing the vehicles weight towards the centre or radius of the bend. The amount of superelevation on a bend is directly related to the radius of the corner and the desired vehicle speed through the corner.

The following table is a guide for providing the superelevation necessary to reduce lateral forces.

The maximum superelevation should be regarded as 1:20.

TURN RADIUS (M)	SPEED (KM/HR)			
	16	24	32	40
45	1:25			
60	1:37.5			
90	1:50	1:20		
150	1:100	1:37.5	1:20	
215	1:100	1:50	1:25	
300	1:100	1:50	1:37.5	1:25

Table 5. Recommended super-elevation

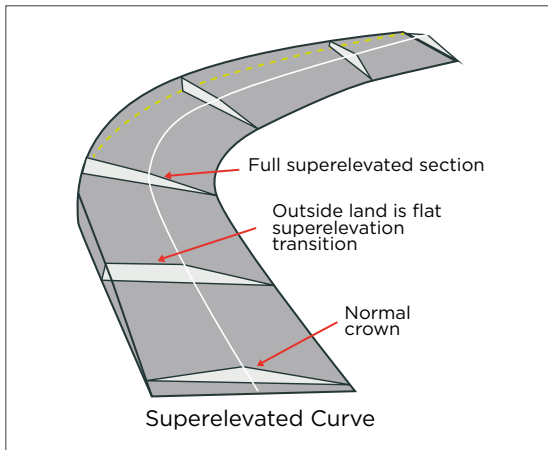

Figure 18. Superelevated bends

Superelevation is a particularly important design consideration for switchbacks on haul roads, as they typically have a small turn radius. On switchbacks, which have the centre of the bend located on the up-side of the road, a well-chosen superelevation rate prevents material being spilled from laden trucks and improves vehicle control.

As with changes in grade, transition into and out of superelevated bends needs to be smooth, so vehicles can be eased into corners. Superelevation transition lengths depend on the cross-fall change and the design speeds. The larger the change in road alignment, the longer the transition needs to be. Transition lengths should be applied so one-third is on the bend and two-thirds are on the tangent (refer Figure 18). Table 6 outlines the recommended lengths.

VEHICLE SPEED (KM/HR)	16	24	32	40	48	56
Cross slope change per 100 m pavement	0.08 m	0.08 m	0.08 m	0.07 m	0.06 m	0.05 m

Table 6. Recommended transition lengths

To illustrate the use of this table, assume a vehicle is travelling at 32 km/hr on normal pavement with a cross-fall of 2%. The vehicle is approaching a switchback with superelevation of 4% the opposite way. The total cross slope change here is 6% (2% plus 4%). For a vehicle travelling at 32 km/hr the recommended change is 0.08 m per 100 m. Therefore the total transition length is 75 m ($(6\%/0.08\text{ m}) \times 100 = 75\text{ m}$).

5.3.6 SIGHT DISTANCE

Sight distance is simply how far along the road a driver can see ahead of their vehicle (see Figure 19). Roads should be designed to give drivers a sufficient distance of clear vision ahead so they can avoid unexpected obstacles. A basic rule of safe driving is that, always, a driver must be able to stop the vehicle within their sight distance. If a driver sees a problem, such as a boulder on the road or a stalled vehicle, they must be able to stop in time to avoid it.

Design roads with viewing distances and alignments so that a vehicle rounding a bend, cresting a hill, descending a grade, or approaching a junction can stop in time to avoid an object in the road or a vehicle pulling onto the road (refer to Figure 20). Consideration should be given to the height of a driver in different vehicles.

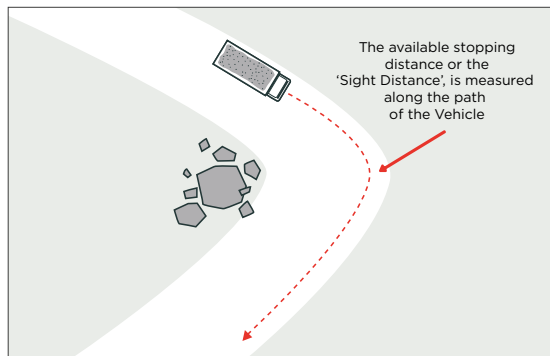

Figure 19. Sight distance

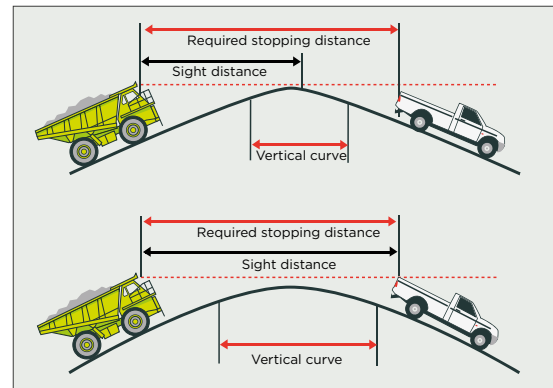

Figure 20. Road alignment

SIGHT DISTANCE IN BAD WEATHER OR AFTER DARK

The sight distance can be reduced during inclement weather, such as rain, snow or fog. Under these conditions, drivers must slow down to the point where they can stop within the available sight distance. Effective headlights, flashing lights and spotlights improve the ability to see and be seen.

When driving after dark, sight distance can be defined by the distance illuminated by the vehicle's headlights. Drivers should reduce their speed so they can bring the vehicle to a stop within the illuminated distance. This distance will vary with the type of headlight. To be most effective, you should keep headlights properly aimed and clean. Speeds should be reduced at night because drivers typically have reduced depth perception, peripheral vision and reaction time.

There is often little contrast in brightness between the background and other objects at an extractive site – especially in snow. Roadside reflectors should be installed to help define the roadway and intersections. For larger vehicles road side reflectors may need to be attached at elevated heights. Vehicles used at night should have lights that can be seen from the side of the vehicle, as well as the front and rear.

SIGHT DISTANCE AT INTERSECTIONS

Sight distance is important at intersections, where a driver must be able to see oncoming vehicles far enough away to safely turn on to or cross the road. Ideally, drivers should be able to pull on to the road, or cross the road, without requiring approaching vehicles to slow down. The main factors in the safe sight distance at intersections are the acceleration ability of the vehicles pulling on to the road and the speed of the oncoming traffic.

Because of the limited acceleration ability of trucks, especially when laden, ample sight distance should be provided. The higher the speed on the road, the longer the sight distance should be.

Avoid putting intersections near hill crests or sharp curves. In these situations, the sight distance will be limited. Intersections should be kept as flat as possible and sight distance should be considered in all directions.

In laying out intersections, the effect of the large blind spot to the right or left side of haulage trucks (depending on the position of the driver's seat), should be considered.

Intersections where trucks need to stop or give way to other vehicles should be angled to optimise the driver's ability to see vehicles coming from both the right and left sides (refer to Figures 21 and 22). For roads used by haulage trucks, avoid roads that intersect at an angle of less than 90 degrees on the opposite side of the driver. Alternatively, compensating measures should be taken (e.g. convex mirrors, reduced speed zones, communication systems or on-board cameras).



When using give way controls at an intersection you should have visibility clearance of 1.2 times the priority road speed limit, nine metres back from the intersection. Where you cannot achieve the visibility clearance a stop control should be used that requires vehicles to come to a complete stop (refer to examples shown in Figures 23 and 24).

Consider the use of traffic signals or boom gates for high-risk intersections.

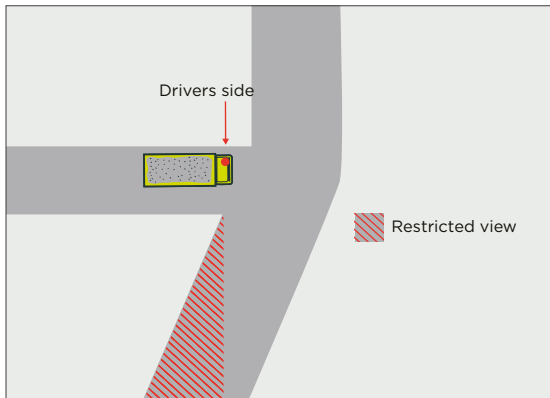

Figure 21. Intersection with restricted view

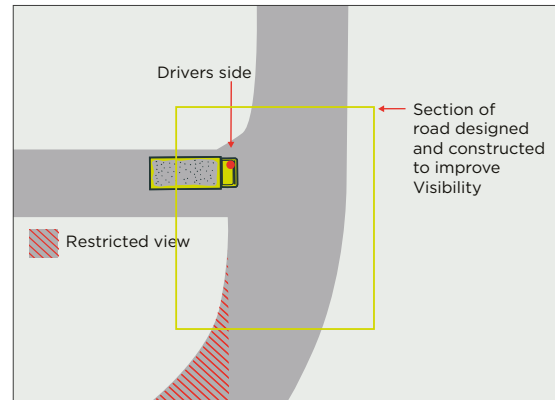

Figure 22. Intersection with improved visibility

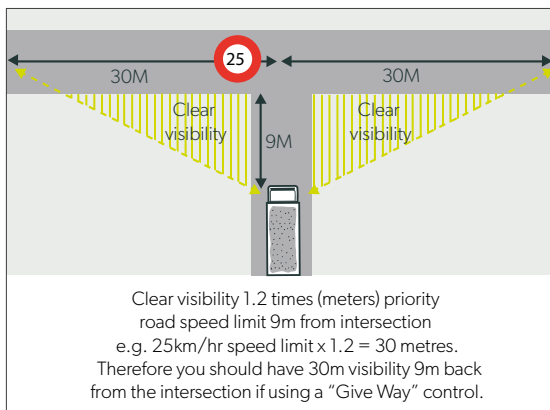

Figure 23. Give way control selection

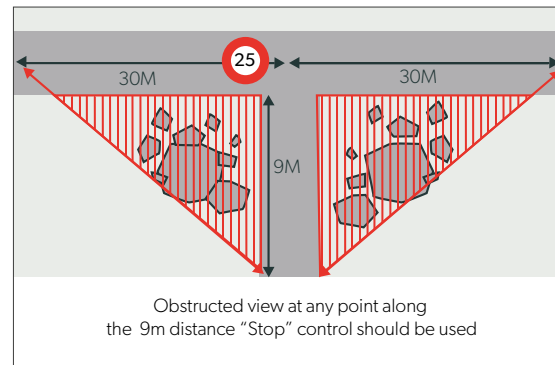

Figure 24. Stop control selection

5.3.7 DRAINAGE

Having good drainage systems will:

- > prolong the life of the road
- > reduce maintenance costs on roads and vehicles
- > minimise downtime
- > minimise adverse health effects on drivers
- > improve tyre life.

Drainage is normally provided using:

Cross fall (or cross slope): Surface drainage is designed to cause the water to leave the road as shallow, non-erosive sheet flow in a way suited to the road material, slope and terrain. To promote drainage either the road surface should be sloped from one side to the other, or the road should be crowned, or raised, in the centre.

Typical cross falls for unpaved roads are 3.5 to 4% and 2 to 4% for paved roads. On haul roads a cross fall between 2% and 4% is preferred. Steeper crowns can increase tyre wear and metal fatigue in trucks. Cross falls should not be carried around a bend. Instead there should be a transition zone between the normal cross fall road and the start of the superelevation of the bend. For more information about superelevation see section 5.3.5.

Free-draining road materials allow water on the road surface to drain down and out but require more detailed design to ensure long term stability. Roadside ditches collect drainage from the road surface and intercept runoff from adjacent hillsides, keeping it off the road surface.

Culverts carry runoff under the road surface to a drainage course. They vary in size from 300 mm concrete or corrugated metal pipes to large shapes 3 m or more in diameter. The inlets and outlets for the larger sections usually have concrete or rock protected headwalls and wing walls to reduce erosion problems. The smaller pipes usually have bevelled end sections for the same reason.

When using culverts, they should be buried deep enough to prevent them being crushed by vehicles passing over them. Manufacturers can provide information about suitable depth and backfill materials.

5.3.8 ROAD PAVEMENT

Surface and drain all roads adequately to make sure vehicles can be driven safely.

The materials that make up the road pavement and road base need to serve two functions:

- > provide adequate traction
- > provide support for the vehicles without excessive sinking or rutting.

TRACTION

A road pavement of gravel or crushed stone is preferred for roads. While some other materials provide better traction when dry, a gravel road pavement offers good traction values in both wet and dry conditions. You may have to import gravel or crushed stone when not available on site. Alternatively, if all weather pavements are not practicable and roads become untrafficable due to weather or under-foot conditions, have procedures in place that outline when operations should stop and when they can restart. Base any such procedures on technically sound risk assessments.



SUPPORT

Rutting of a soft pavement can create a hazard by affecting a driver's ability to control the vehicle and by subjecting the driver to rough or jarring conditions. Rutting occurs when tyres sink into the pavement because the road pavement material doesn't offer adequate support. Fine-grained soils, even when well-compacted, may not support the tyre loads imposed by large haul trucks, especially during wet conditions and around sharp corners.

To prevent or minimise rutting of the road, a road base material with sufficient strength to support the tyre loadings should be provided. A layer of gravel or crushed stone, for example, has higher bearing strength and will distribute the tyre loadings over a larger area. The use of a layer of geotextile can assist in providing a road base that will better support the tyre loadings. A great deal of maintenance work will be necessary to keep the road in good condition where road base material has inadequate support strength.

The use of insitu-stabilisation techniques using cement or lime can be considered.

5.3.9 ROADSIDE EDGE PROTECTION

The failure to provide adequate edge protection is the cause of many vehicle incidents. Providing adequate windrows or guardrails is required where there is a change of level, drop, pond, or other hazards which would put the driver, or others, at risk if the vehicle left the road.

Risk assessments will determine the type of edge protection or runaway provisions required.

PURPOSE OF WINDROWS

Roadside windrows are a common safety feature along elevated roadways. However, the capability of windrows may be misunderstood, and it's dangerous if they give drivers a false sense of security.

Windrows mainly:

- > give the driver a visual indication of the location of the roadway edge
- > provide a sense of contact to the driver if they accidentally make contact with the windrow
- > provide restraint to the vehicle and give the operator the opportunity to regain control and keep the vehicle from leaving the road
- > keep a vehicle back from the edge by a distance equal to at least the width of the windrow.

EARTHEN WINDROWS

Windrows used on roads where heavy vehicles operate need to be of sufficient height and width, and constructed with suitable material, steeper on the road side to serve the four functions indicated above.

Windrow suitability is normally judged based on its height, although the effectiveness of a windrow also depends on its width (or thickness) and its firmness.

Earthen windrows should be a minimum of half the wheel height of the largest vehicle that uses the roadway.

Windrows less than this or with curved slopes, make an ideal ramp for vehicles to run over and are totally ineffective.

Large broken rock should not be used on internal edges of windrows due to the risk of tyre damage or punctures.

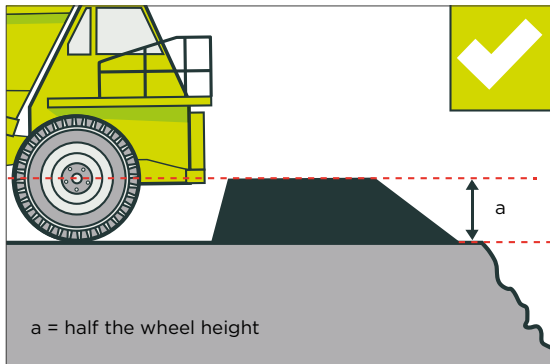

Figure 25. Suitable windrow – firm material big enough to absorb the vehicle's momentum with a steepened inside slope

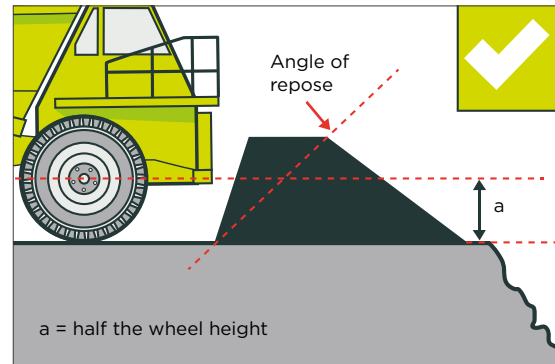

Figure 26. Suitable windrow – the width of the windrow is as wide as the normal angle of repose

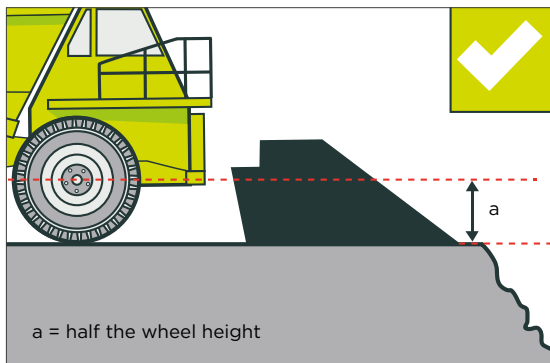

Figure 27. Suitable edge protection – a rock with material in between which can safely absorb the impact

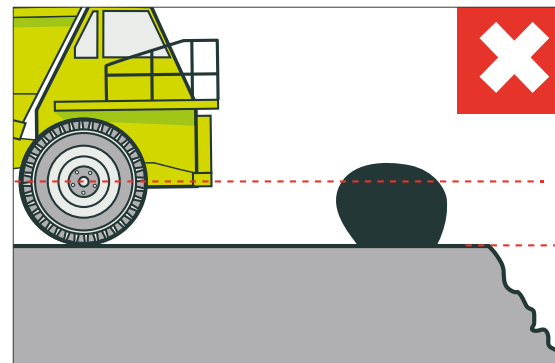

Figure 28. Unsuitable edge protection – blocks of stone can be pushed out of the way

Support installation and construction of windrows by robust design calculations should be determined by a competent person.

GUARDRAILS

You should engage a qualified engineer with suitable experience to determine adequate design and construction of guardrails.

If guardrails are used instead of windrows, make sure they are capable of:

- > providing a visual indicator of the location of the edge of the road
- > giving a sensation of contact to the driver if the guardrail is accidentally hit
- > restraining or impeding the vehicle's passage over the edge.

Considering the large size and mass of haulage trucks, guardrails generally need to be higher and stronger than the guardrails typically used on public roads.

Embed guardrail posts deep enough to provide adequate resistance and make the posts and horizontal guide members strong enough to restrain or impede the passage of the vehicle.

Installation and use should not exceed the manufacturers recommended limits in respect to vehicle type, size and weight.

5.3.10 RUNAWAY PROVISIONS

Safety features should be incorporated into road design to guard against the consequences of runaway vehicles. As previously noted, typical edge-of-road windrows should not be relied on, by themselves, to stop a large haul truck. However, other methods such as the use of escape lanes and/or arrestor beds can bring a runaway vehicle to a safe stop and prevent an accident.

Two types of runaway control are centre berms and escape lanes.

Centre berms are piles of loose granular material placed strategically along the centreline of the road (refer to Figure 29). In the case of brake or retarder failure, the driver manoeuvres the vehicle in line with the berm so the vehicle straddles the berm and is brought to a halt. Consider the following when installing centre berms:

- > the nature and size of the equipment that might need to drive on to or straddle the centre bench
- > using material to provide sufficient drag on the vehicle
- > positioning of the centre berms so vehicles have limited time to pick up momentum
- > adequate space between berms to allow the driver time to position the vehicle.

Escape lanes can be used where space is available (refer Figures 30 and 31).

Consider the following when installing escape lanes:

- > The size and expected speed of a runaway vehicle that might be required to enter the lane.
- > The alignment of the lane and the road.

An operator of a runaway vehicle should be able to steer the runaway vehicle into the lane.

- > Size and length of the lane. The lane needs to be wide enough and of sufficient length to allow vehicle access and time for it to slow and stop.
- > Construction material for the lane arrestor bed should offer a high rolling resistance and not tend to compact (e.g. loose gravel or crushed aggregate).

GROSS VEHICLE WEIGHT	A	B	C
Less than < 45,000 kilograms	3.5 m	1 – 1.2 m	4.5 – 5 m
45,000 to 91,000 kilograms	3.5 – 4.5 m	1.2 – 1.5 m	5 – 6 m
91,000 to 181,000 kilograms	4.5 – 5.5 m	1.5 – 1.8 m	6 – 7 m
More than 181,000 kilograms	5.5 to 10 m	1.8 – 3.5 m	7 – 13 m

Table 7. Weight of vehicle in relation to required size of centre berm

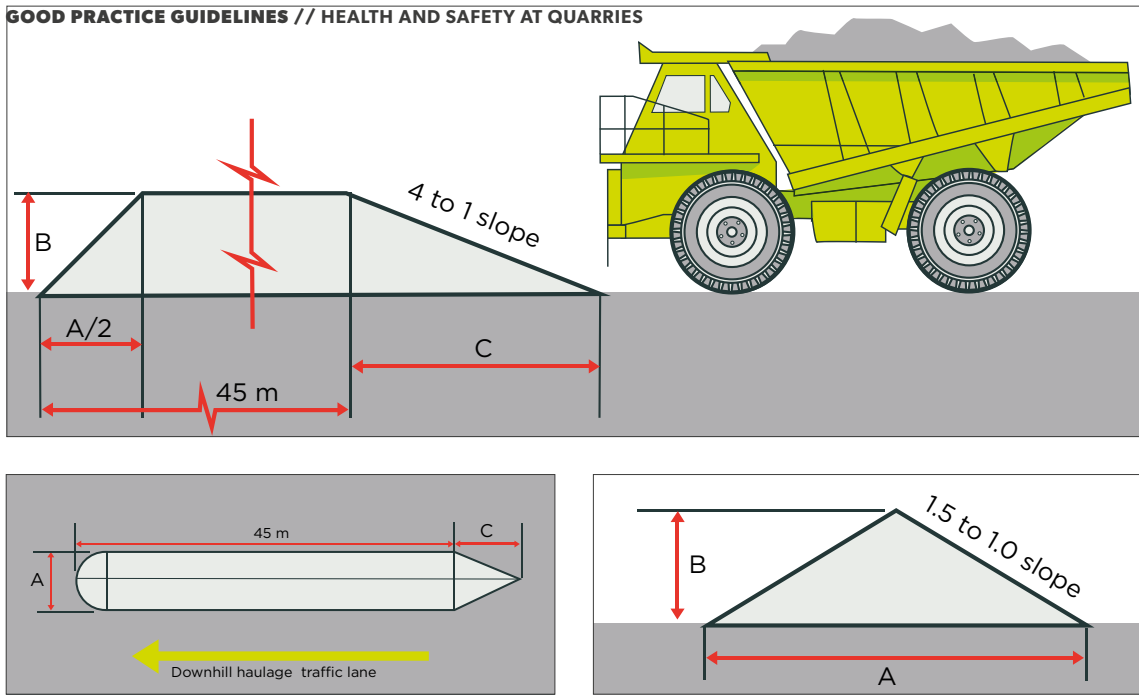

Figure 29. Runaway-vehicle centre berm

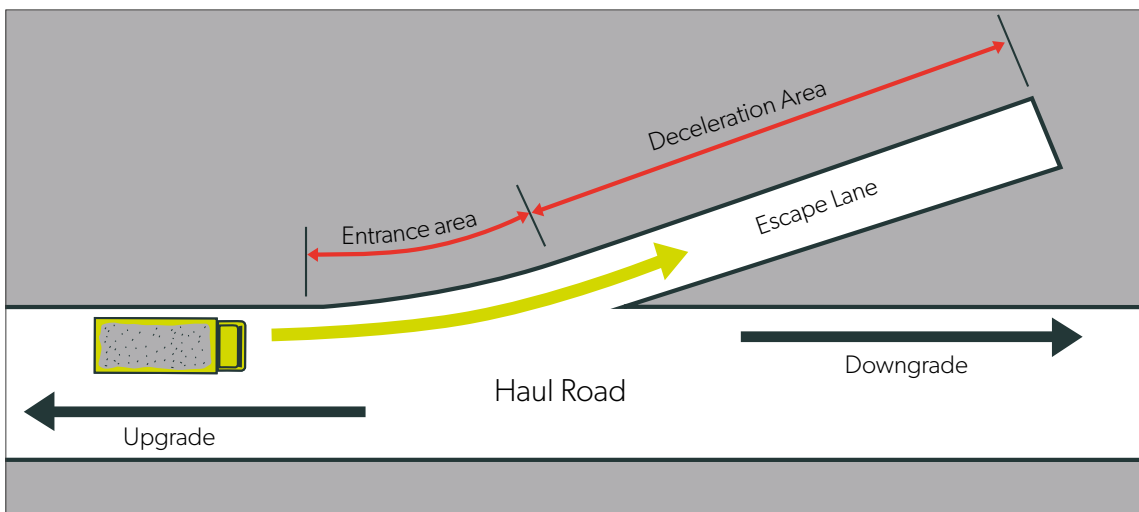

Figure 30. Plan view – haul road escape lane

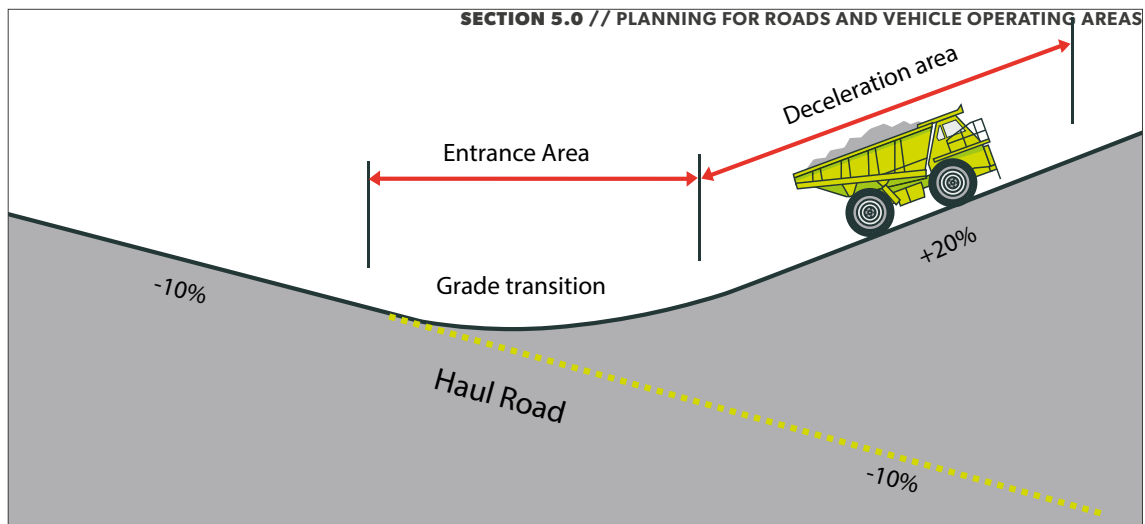

Figure 31. Profile view – haul road escape lane

5.3.11 PARKING AREAS

Consider the following when establishing parking areas:

- > separating light and heavy vehicles, including private vehicles (e.g. workers' cars)
- > locating on as flat, level ground as possible with a downward slope from buildings such as workshops to prevent unintended movement forward
- > being consistent in design and layout
- > where possible, have one-way systems (limit need for reversing). If this is not possible, vehicles should reverse into parking bays and drive out forward
- > using stop blocks or spoon drains to prevent unintended movement of vehicles
- > managing or limiting pedestrian and light vehicle interaction with heavy vehicles
- > having clear signs.

For more detailed information on parking areas, see section 11.3.4.

5.3.12 DUMPS OR STOCKPILES

When establishing dumps or stockpiles, think about the vehicle activities that will occur in these areas and set up controls to manage the risks including:

- > ensuring there is sufficient room for vehicles to operate
- > where possible, have one way systems
- > managing stockpiles so they do not encroach on vehicle operating areas
- > managing the size of the stockpile so that it does not restrict lateral vision of operators
- > restricting light vehicles and pedestrian access
- > providing additional lighting if operating at night.

For more detailed information on tips, see sections 4 and 8.

5.3.13 WORKSHOPS AND FIXED PLANT AREAS

A vehicle collision with a pedestrian, machinery or other vehicle is much more likely in workshops and process plant areas due to the restricted vision around fixed plant and service bays. To reduce the risk of this occurring:

- > provide specific parking areas

- > restrict pedestrian and vehicle access as much as practicable
- > establish clearly identified pedestrian crossings and walkways
- > provide bollards or barriers to protect infrastructure close to roads
- > establish and sign appropriate speed limits.

5.3.14 SLOPE HAZARDS ABOVE AND BELOW ROADS

Road hazards can be created due to instability of material either above or below the road. The hazard from above is for rock falls or slides of material onto the road that could endanger passing vehicles. The hazard from below is that ground will not be stable or have sufficient strength to support the vehicles using the road, especially when roads are constructed on fill areas. You should establish exclusion zones to avoid these hazards. Specialist geotechnical advice should be obtained if in doubt.

Pay special attention to the stability of any area where water is seeping out of a slope – the presence of water tends to make slopes less stable. For more detailed information on drainage and depressurisation see section 3.5.5 and 5.3.7.

For more detailed information on slope hazards, see section 3.

ROCK FALLS

Where roads are adjacent to any highwalls, slopes or dumps containing large rocks, you should make sure vehicles are protected from potential rock falls. Rock slopes tend to become less stable over time due to factors such as weathering and the effects of water. They should be regularly checked for overhangs, open joints or other evidence of unstable rock. Unstable material should be either removed, supported, or the area isolated so drivers are not exposed to a potential rock fall (e.g. catch berms, catch bunds or rock fall fences). Catch bunds should be placed along all non-active faces to create a no-go zone for workers and equipment.

Consider how high and how far out from the wall the structure must be if using catch berms or rock fall fences. This is to prevent passing vehicles from being exposed to the hazard by absorbing and dissipating the energy of the falling rock. How far a piece of falling rock will come out from a wall depends mainly on the steepness of the wall and the presence and condition of any structures. With a vertical wall, a rock fall would tend to end up near the base of the wall. However, with a sloping wall, or a wall with benches that have accumulations of material on them, the falling material will tend to bounce and be propelled farther out from the base of the wall.

Maintenance regimes should include clearing of slips or rock falls that will reduce the catchment area if left to accumulate.

For more detailed information on ground support, see section 3.

CUT AND FILL ROADS

Filled roads should be constructed in compacted, horizontal layers. When fill is placed on an existing slope, the layers should be tied-in by first removing vegetation and cutting horizontal benches into the existing slope material. Any springs or seepage areas should be collected in a drain to prevent the fill from becoming saturated. Erosion of fill slopes should be repaired before the condition threatens the safety of the road.

Watch for signs the ground below the road may be unstable, such as tension cracks or settling. Slopes may become unstable as they absorb rainfall, become eroded or are loaded by the weight of heavy vehicles. The use of geotextile, or other stabilising materials may need to be considered.



5.3.15 TRAFFIC MANAGEMENT PLAN (TMP)

Regardless of the size of the site, you can produce a site specific TMP to control the identified risks associated with vehicle movements on site. The TMP will form a subset of the roads and other vehicle operating areas PHMP.

The TMP uses the controls from the risk assessment to particularly control traffic. The other controls, e.g. road design, live in the main part of the PHMP. From an operational aspect, having a TMP can make it easier for the workforce to understand the site traffic rules.

TMPs are usually documented procedures that are visual in nature and identify vehicle routes, flow, access points, parking areas and other vehicle control areas.

TMPs (also known as vehicle movement plans – VMPs) should be updated to reflect any changes within the operation and communicate these changes to all workers and visitors by induction, signage or tool box meetings. These will be effective if change management processes are in place.

5.3.16 TRAFFIC SIGNAGE AND MARKINGS

The Resources Regulator considers it best practice to use signs (including delineators) and line markings for drivers and pedestrians consistent with those used on public roads (where a suitable sign or marking exists). This is to ensure instructions are easily recognisable to drivers and pedestrians (i.e. it is a learned habit).

For more detailed information on traffic signs and markings see the Roads and Maritime Authority www.rms.nsw.gov.au/roads/safety-rules/road-rules/signs.html and the Australian Road Rules published by the National Transport Commission www.ntc.gov.au/

Keep signs clean to make sure they are continually effective. Maintaining signs should form part of the road maintenance program. Use illuminated or reflective signs, markings or delineators where driving is likely to be carried out in the dark.

Use delineators suitable for the size of the largest vehicle using the road.

Consider taller delineators (road markers) in snow fall areas to make sure they are always visible where snow can drift or graders may bury them.

Signs could be used to inform drivers or pedestrians about the routes to use and also to instruct people how to behave safely (e.g. whether they should use protective equipment) (refer Figure 32). However, be careful to avoid listing important instructional information on a single sign.

Warning signs to show hazards along the way could also be appropriate (refer Figure 33).

5.3.17 SPEED LIMITS

Speed limits should be established based on the layout and condition of the roads and the capabilities of the vehicles using the roads.

For a given section of a road the speed limit should be the speed at which, under normal conditions, sight



Figure 32. Example of sign helping arriving drivers know what to expect

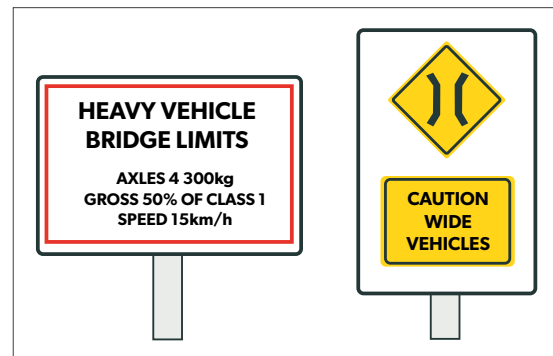

Figure 33. Example of weight restriction sign and narrow bridge sign

distances are adequate, the curves can be safely negotiated and any downgrades can be travelled without exceeding the braking capabilities of the vehicles. Additionally, the speed should be so the driver can operate the vehicle safely and with a reasonable level of comfort and control.

Any such speed limits should be regularly monitored and reviewed to make sure they are still appropriate. Install adequate signs where speed limits are set.

Driving conditions can vary considerably due to:

- > changing weather conditions reducing visibility
- > general road deterioration (reducing traction or becoming more slippery)
- > volume of vehicles which accelerates wear and tear on bends and other areas where braking takes place
- > possible interaction with pedestrians.

Emphasise to drivers the speed limit only applies under ideal driving conditions, and they are responsible for reducing their speed to a safe level when road, weather, or other conditions are less than ideal. Sites may implement rules for temporary speed limits. For example, under fog conditions speeds are reduced.

SPEED ON DOWNHILL SECTIONS

The speed limit posted on downhill sections should consider the braking capabilities of the vehicles using the road. On haul roads, speed limits need to be reduced in advance of a downhill section to account for the lag time involved before retarders are engaged (if fitted). Vehicle operator manuals should be consulted to determine braking capability and retarder lag time requirements. It is common to have different speed limits for uphill or downhill travel. Signs recommending gear selection may also be required.



SPEED AROUND A BEND

Speed limits around bends can only remain the same as the straight sections of road where the superelevation and radius has been designed to allow this to happen. Where this is not possible, reduce speed limits. Speed limits will need to be sign posted accordingly.

5.3.18 LIGHTING

Lighting on extractive sites is more difficult than lighting a public road because of the uneven surfaces and the consequential deceptive effects of shadows.

You must provide adequate lighting to enable workers to move safely around places of work. In addition to vehicle mounted lights, lighting should be provided:

- > around plant, services and buildings
- > on pedestrian routes
- > where loading and unloading takes place
- > at dump points
- > at water bodies where access is required to pontoons, pumps, and so on
- > where practical, at important instructional signs.

Lights provided on vehicles must be sufficient to enable them to be driven safely, but additional lighting may be required for manoeuvring operations such as reversing, dumping, or at intersections.

Lights should be positioned so they do not dazzle the driver when they come around a corner or drive over a crest. When using diesel or petrol-powered lighting systems you should make sure they:

- > are positioned safely (e.g. off-road lanes) and protected from impact
- > have sufficient duration to last the shift without refuelling
- > form part of the maintenance schedule.

5.4 MAINTAINING CONTROL OVER ROADS AND OTHER VEHICLE OPERATING AREAS

The PHMP should have identified control actions that will be implemented to ensure that what has been planned is carried out. This means a structured program of inspections should be put in place to check and verify that the controls for roads and other traffic areas are maintained once implemented. These should be inspected on a regular basis by competent people. The system should have a process whereby the hierarchy of reports are reviewed by supervisors and managers.

The process should include inspections by external people if the need is warranted.

An example is an inspection regime to check all signs are in place and legible and windrows are in place and correctly built.



**PART
C**

This part of the document sets out site safety practices for working with explosives, managing ground instability, tipping and dumping material, storing water and tailings, and managing traffic.



06

PART **C**

Using Explosives

IN THIS SECTION:

- 6.1 Hazard management and emergency planning for explosives**
- 6.2 Maintaining, transporting and storing explosives**
- 6.3 Shotfiring – safe systems of work**
- 6.4 Explosives selection criteria**
- 6.5 Drilling, charging and blasting**
- 6.6 Post-firing**
- 6.7 Minimising blast damage**

The use of explosives to break rock at a mine or quarry can be a hazardous process. This process must be managed to protect workers and the general public from the adverse consequences of blasting and the mishandling of explosives. With the correct control and management strategies in place, the potential for incident is significantly reduced.

This section addresses explosives and explosive precursors (such as ammonium nitrate mixtures, emulsions or gels containing greater than 45% ammonium nitrate). Except where there are specific comments about explosives precursors, read references to explosives as referring to both explosives and explosive precursors.

This section describes:

- > how to develop an explosives control plan (which must cover specific aspects of work with explosives)
- > risk assessment
- > blast design and charging
- > how to select explosives
- > how to safely carry out a blast
- > safety procedures to follow after a blast.

Controls for transport, storage, packaging, use, manufacture, and disposal of explosives are set by the *Explosives Act 2003 (Explosives Act)*, *Explosives Regulation 2013* and Standards or codes referred to in the Regulation.

Under the *Explosives Regulation 2013 (Explosives Regulation)*, anyone who carries out activities to which any of the following standards or codes apply must ensure the activity is carried out in accordance with that standard or code:

In relation to explosives:

- > AS 2187.0 – 1998 *Explosives – Terminology*
- > AS 2187.1 – 1998 *Explosives – Storage, transport and use – Storage*
- > AS 2187.2 – 2006 *Explosives – Storage and Use – Use of explosives.*
- > the *Australian Code for the Transport of Explosives by Road and Rail (Australian Explosives Code)* and as in force from time to time.

In relation to explosive precursors:

- > the *Australian Code for the Transport of Dangerous Goods by Road and Rail (ADG Code)*
- > AS 4326 – *The storage and handling of oxidizing agents*
- > The Regulations also specify controls to ensure heat, shock, pressure, spark energy and electromagnetic radiation are safely managed.

Safe and efficient blasting requires all quarry and mine operators and associated supervisors and contractors to understand and follow correct procedures for handling explosives. Practices that lower the risk of premature or inadvertent explosion and prevent the mishandling of explosives are important in maintaining safety. Any workers handling explosives must be competent or always strictly supervised by a competent person.

Licences are required under the *Explosives Act 2003* for any person who handles explosives.

Everyone working with explosives must also have the appropriate security clearance under the *Explosives Act 2003* or be supervised by a person with a security clearance.

6.1 HAZARD MANAGEMENT AND EMERGENCY PLANNING FOR EXPLOSIVES

6.1.1 EXPLOSIVES CONTROL PLAN

The use of explosives at a mine poses a risk to health and safety. In accordance with WHSMPS Regulation clause 26(6), a risk assessment must be done to assess all hazards, and identify controls so as to control risks associated with explosives on the mine site. From this risk assessment the mine operator must prepare an explosives control plan (ECP) for the mine, setting out how the operator will manage those risks.²

The ECP forms a part of the safety management system (SMS) for the mine.

The WHSMPS Regulation schedule 2(4) specifies particular content that an ECP must have. These are the control measures associated with explosives taking into account:

- > the potential for unintended or uncontrolled detonation of explosives
- > the characteristics of relevant explosives and the purposes for which they are to be used
- > the characteristics of the places in which the explosives are to be used
- > the full set of phases for the use of relevant explosives such as the charging and firing phases
- > the potential for explosives to deteriorate
- > the potential for the theft or misuse of explosives
- > the potential for the ejection of flyrock or other material as a result of the detonation of an explosive.

The ECP must also set out procedures for:

- > inspecting, reporting, isolating and disposing of deteriorated or damaged explosives
- > finding, recovering and disposing of explosives that misfire
- > the inspections, testing, reporting and maintenance of equipment used for manufacturing, storing, transporting and delivery (if applicable) of explosives
- > accounting for explosives
- > transporting and storing of explosives, including the equipment for transporting and storing of explosives
- > co-operating, consulting and coordinating with explosives contractors or any other person authorised under the *Explosives Act* regarding storage, handling, transportation and use of explosives under licence conditions
- > keeping of a register identifying persons who are licenced under the *Explosives Act 2003* to transport, use, store or handle explosives
- > the procedures for ensuring that any person transporting, using, storing or handling explosives has any licence necessary under the *Explosives Act 2003*.

² Clause 26 WHSMPS Regulation

In all cases above, when undertaking the risk assessment, the operator must ensure that explosives are:

- > safe to handle
- > fit for their intended use
- > as insensitive as is reasonably practicable to shock, sparks, friction and the environment in which they will be stored, transported and used, and
- > so far as is reasonably practicable, simple to store, use, transport and control.

6.1.2 CONTRACTOR HEALTH AND SAFETY MANAGEMENT PLAN

Many mines use specialist contractors to provide blasting services. Use of specialist contractors does not relieve mine operators of obligations in relation to explosives and the ECP but it may change how plans are prepared.

Duty holders who have a responsibility for the same matter, such as a mine operator and explosives contractor must consult, cooperate and coordinate their activities so far as reasonably practicable, to achieve safety. There are additional specific processes to be followed by mine operator and the contractor under the WHSMPS Regulation clauses 19 to 22 inclusive. (See 2.9 for more information.)

Mine operators should use the mandatory requirements in relation to explosives and the requirements for the ECP to help select the most suitable contractor and to review the contractor's health and safety management plan. The ECP can reference content from the contractor's health and safety management plan as a way of setting out controls. The ECP should also set out how the mine operator coordinates and manages the interaction with the explosives contractor.

6.1.3 EMERGENCY PLAN

The emergency plan for the mine must contain information as detailed in WHSMPS Regulation Schedule 7. Potential emergencies associated with explosives should be considered in developing the emergency plan. For information on the emergency plan see Section 17.

Where more than 50 kg net quantity of explosives, or more than 50 tonnes of security sensitive dangerous substances are stored, the Explosives Regulation requires an emergency plan. This emergency plan can be included in your mine's Emergency PCP provided all requirements outlined in the Explosives Regulation have been addressed.

6.2 MAINTAINING, TRANSPORTING AND STORING EXPLOSIVES

The mine operator must ensure that explosives and explosive precursors to be used are:

- > safe to handle
- > fit for their intended use
- > as insensitive as is reasonably practicable to shock, sparks, friction and the environment in which they will be stored, transported and used
- > so far as is reasonably practicable, simple to store, use, transport and control
- > The mine operator must also ensure that any dealing with an explosive or explosive precursor at the mine is in compliance with the *Explosives Act 2003* and Australian Standard AS 2187 *Explosives—Storage, transport and use* (see WHSMPS Regulation clause 31).



All equipment used for shot-firing should be checked before use and kept and maintained in a safe operating condition. The equipment should be serviced on a regular basis, dependant on the amount of usage and original equipment manufacturers (OEM) recommendations.

Mining operations must address the inspection and reporting on the safety of shot-firing equipment, including how appropriate action will be taken to make the equipment safe in their ECP.

6.2.1 TRANSPORTING EXPLOSIVES

Once delivered to a mine, the transport of explosives should be managed in accordance with the mine's safety management system and explosives control plan.

Transport to and from the mine is regulated under the Explosives Act and Regulation. The person in charge of any transportation of explosives not on a mine site must ensure all requirements under the *Explosives Act 2003* and Regulations are met. These include:

- > applying to SafeWork NSW at least seven business days before proposed departure for approval to transport explosives on prohibited routes (if required)
- > ensuring the security of explosives including ensuring people with unsupervised access to explosives have a security clearance under the *Explosives Act 2003*.

Under the NSW Explosives Regulation 2013 it is the responsibility of the individual or responsible person with a licence to transport explosives to ensure all nominated drivers:

- > comply with the requirements of the Australian Explosives Code relating to the transport of explosives by road and rail
- > are at least 21 years of age
- > have sufficient training and experience to drive the vehicle(s) concerned
- > have been examined by a medical practitioner, and found not to have any medical or physical condition that would impair the individual's ability to perform their driver duties.

The Australian Explosives Code must also be complied with. The explosives code sets out a range of matters relating to transport of explosives including:

- > vehicle requirements
- > documentation and packaging
- > marking and label requirements
- > making sure that the amount of explosives transported is within safe load limits
- > minimum numbers of fire extinguishers dependent on what is being transported
- > separation distances
- > driver training
- > limitations and other requirements in relation to vehicle stopping.

Mining operations must address transportation of explosives at the mining operation in their ECP including inspection and reporting on the safety of equipment and how the equipment used for transportation will be made safe.

This will require the PHMP for roads and other vehicle operating areas to consider road designs, access etc to accommodate trucks that deliver explosives, and correspondingly the ECP will need to link to the PHMP where common hazard control measures are the same.

6.2.2 STORAGE OF EXPLOSIVES

Explosives must be stored in accordance with the AS 2187.1 – 1998 *Explosives – Storage, transport and use (Part 1 Storage)*.

This Standard covers:

- > requirements for storage of explosives in secure magazines, including construction, protection from fire, water and lightning
- > requirements for the storage of precursor in secure stores
- > segregation and separation distances
- > emergencies.

For more detailed information on storage of explosives refer to the standard.

Explosives can only be stored in accordance with a licence. Authorisation for storage requires submission, with the application form, of a security plan. Information on how to complete a security plan is provided in the SafeWork NSW publication *Security plan for the storage and handling of explosives (including explosive precursors) guide* (catalogue no. WC04687) available on the SafeWork website.

ACCOUNTING FOR EXPLOSIVES

The explosives control plan must set out the procedures used for the accounting of explosives at the mine (Schedule 2 clause 4(2)(e)).

The procedure should allow for knowing at any one time the amount of explosives secured on site, amount in transit and the amount used on a blast.

SECURITY OF EXPLOSIVES

The *Explosives Act 2003* and Regulations specify the requirements for securing explosives. See the SafeWork NSW publication *Security plan for the storage and handling of explosives (including explosive precursors) guide* (catalogue no. WC04687) available on the SafeWork website.

6.3 SHOT-FIRING – SAFE SYSTEMS OF WORK

You must have safe systems of work in place that take into account obligations under the WHS laws, Explosives Act and Explosives Regulation. Shot-firing site procedures or rules should include:

- > hazard identification and checklist for clearing the blast zone before final connection
- > a clear and concise procedure detailing the role of sentry guards at a site
- > clearance distances and suitable shelter for all workers and people in the vicinity throughout blasting activities
- > face checks (before design of drill plan and/or face profiling), installation of suitable edge protection and delineation of the blast zone from general operational activities
- > storage, transport and security of explosives (including magazine management if required)
- > suitable blast warning signals (visible and audible), isolation barriers and warning signs
- > clear delineation of who should be in attendance throughout the blasting application
- > protection against unintended initiation
- > misfire management.

The mine operator or other PCBU managing the initiation of explosives must manage risks to ensure health and



safety associated with the unintended initiation of explosives. Control measures for this must be set out in the ECP.

Ensure there is clarity around the roles and responsibilities for each blast undertaken.

6.3.1 INDIVIDUAL BLAST RISK ASSESSMENT

A formal risk assessment should be completed for each blast, identifying the hazards and controls at each stage, including the extent of the blast exclusion zone during the firing sequence.

Any risk assessment and subsequent hazard controls should be agreed to and approved by all the relevant parties involved in the blasting process before blasting.

Factors to consider during the risk assessment may include (but are not limited to) the following:

Blast considerations:

- > the type of blast (cast, stand-up, centre fire, pre or mid split, secondary and riprap)
- > aim of the blast (maximum fragmentation, maximum heave, reduction in air overpressure or vibration to assist in environmental control).

Geology of the area:

- > the ground type (hardness or bedding planes)
- > known geological abnormalities within the blast design area (including the face and any potential cavities and/or caves that may have been encountered throughout loading of explosives)

Blast design:

- > burden and spacing
- > bench height
- > maximum instantaneous charge (MIC) weights to ensure environmental control
- > powder factor
- > initiation timing
- > equipment and personnel safety (flyrock)
- > access to and from the proposed blast
- > declared exclusion zone
- > location of equipment and workers during the blast
- > location of external infrastructure potentially affected by the blasting activities (buildings, roads, rail, underground services and power).

Environmental considerations:

- > historical records of flyrock events
- > understanding of minimum burden to be blasted to reduce risk of elevated air over pressure and potential for flyrock
- > presence of water
- > historical or existing underground workings
- > the formation and management of any blast fume
- > radio communication black spots
- > weather conditions (overcast and/or low-pressure systems can increase air over pressure monitoring results).

6.3.2 BLAST DESIGN

Blast designs will vary from site to site as different types of rock require different types of explosives and technologies to be effective. Blast design should be tailored for each blast, in view of the conditions on the site. To achieve success, site-specific conditions should be evaluated, including:

- > the intended pit design and compliance with the mine plan
- > geology, especially structure, hardness and any other potential geological structures that may cause risk during blasting operations
- > water conditions (perched aquifers, groundwater and surface water)
- > vibration prediction
- > angle of initiation
- > blast pattern
- > available free faces
- > environmental consideration (dependant on the area of the blast technologies including face profiling, bore tracking and the use of electronic initiation systems may be required)

Once these conditions have been defined, a controlled blast design can be developed that considers site based risks.

The design should:

- > make sure rock movement is contained within the declared blast exclusion zone and include any special precautions required to achieve this (e.g. additional or false burden, use of blast mats)
- > control ground vibration and air blast
- > minimise the risk of misfires
- > enable the location of any misfired blasts to be determined accurately
- > keep back-break to a minimum through optimised blast planning
- > ensure the shape of the muck pile suits the loading equipment at the site
- > ensure muck piles are created so that access for face scaling can be carried out
- > include consideration as to the type of bulk explosive (ANFO or emulsion) and initiating explosive (none or electronic).

6.4 EXPLOSIVES SELECTION CRITERIA

6.4.1 GROUND CONDITIONS

When selecting explosives, the objective is to ensure reliability and safety for the ground conditions present.

Modern explosives used in mining are very safe when handled correctly. They can however explode if subjected to excessive or prolonged friction, impact, shock or heat.

All blast holes containing water should be recorded. To avoid the risk of a misfire, wet blast holes should be charged with an explosive that has appropriate water-resistant properties (emulsion based). If damp blast holes are required to sleep, an explosive with some water-resistant properties are recommended. Explosives containing sufficiently high levels of emulsion are water resistant and are a preferred option for managing damp or wet blast holes. Use a clear identification system that ensures priming and charging of wet blast holes is appropriate, for example spray painting the depth of water next to the blasthole is a common practice.



Additionally, undertaking dipping of the blasthole the day before charging will give the operator/shotfirer an accurate understanding of which holes may require dewatering or emulsion-based products.

6.4.2 BLASTING IN OXIDISING OR REACTIVE GROUND

Both sulphide minerals and coal may oxidise rapidly when broken and exposed to air. In operations where such minerals are present, carry out tests to determine if the ground is reactive.

The explosives to be used and the charging practices to be adopted should be developed in consultation with explosive manufacturers/ contractors and consider the following general precautions:

- > Sheath ANFO explosives to inhibit exothermic reaction between the explosives and the material to be blasted.
- > Wash down all exposed surfaces within the blast vicinity to make sure there is no fuel available for a secondary explosion.
- > Use the correct amount and type of stemming in all blast holes to inhibit the development of a flame front at the collar.
- > Use low explosive strength detonating cord that is not in contact with rocks or dust to limit raising and igniting reactive dust.

More information is available in the Australian Explosives Industry and Safety Group (AEISG) code of practice for elevated temperatures and reactive ground.

6.5 DRILLING, CHARGING AND BLASTING

6.5.1 DRILLING BLASTHOLES

The main risks associated with the drilling of blast holes are residual explosives from previous blasts being encountered and initiated, and inaccurate drilled blast holes creating an unsafe situation during firing. Inaccurate drilling could be attributed to geology of the rock source or operator skill levels.

Blast geometry and design is imperative to create safe discharges and blast results.

Blast hole diameter, inclination and depth should be adequately designed and recorded for the selected drill pattern. Correct drilling of blast designs will ensure safety hazards such as over break, flyrock or air blast are significantly reduced. A drillers log should be provided to the driller and the operator should note any potential inconsistencies within the drill hole including interception of water (and at what depth) and the location of any cavities or caves.

The following standards and procedures should be in place:

- > The drilling site should be prepared and blast holes marked before drilling.
- > Drilling should not be carried out on any face or bench until it has been examined for misfires and suitably treated (refer to section 6.6.3.2 for the treatment of misfires).
- > The driller should record details of every blast hole including date, time, depth, inclination and position relative to a fixed point or benchmark.
- > The driller should record any unusual events during the drilling (e.g. cavities, soft rock, an inability to drill designated blast holes, redrills).
- > When positioning the drill rig or while drilling near the edge of the bench, the drill rig should be positioned so the operator has a clear view of the edge at all times and be far enough away to prevent the drill rig toppling over the edge.

- > Drilling should not be carried out in a hole where any part is considered within an unacceptable distance from a hole containing explosives.
- > If face profiling and bore tracking holes for accuracy, the driller should be provided with results to assist them with ongoing accuracy of drilling.
- > Where a driller is drilling near the edge of the bench, the side of the drill rig that is used for driver access should not be on the edge side of the rig.

If it is necessary to drill relatively close to an old blast hole or butt that is suspected of containing explosives, it should only be carried out after the old blast hole or butt has been flushed and desensitised. This practice should be avoided at all times if possible.

6.5.2 CHARGING OPERATIONS

CLEARING BLASTHOLES

Blast holes should be checked before loading to make sure they are clear and drilled to the correct depth. Any blocked blast holes should be cleared and short blast holes redrilled where possible. Short blast holes can lead to increased toe being left and create digging issues. Overcharging can cause increased environmental risk including flyrock, air blast and increased vibration.

DISTRIBUTION OF INITIATION EXPLOSIVES

Initiation explosives should be placed near the blast hole collar so they are not in the way of the loading and stemming process. It is also important that boosters or detonators cannot be accidentally knocked into blast holes or lost in drill cuttings. If these situations are likely to occur then a method of securing the initiation explosives near the blast hole collar should be used.

PLACING INITIATION EXPLOSIVES IN BLASTHOLES

Boosters and downhole detonators used to form the primer should be compatible and used in accordance with the manufacturer's recommendations. Once assembled, the primer should be located down the blast hole without using undue force and taking care to avoid unnecessary material build-up between the primer and explosives column. The following general precautions should be taken:

- > Check explosives for damage.
- > Report any damaged explosive to the shotfirer to address.
- > Place the tails of the downline neatly at the collar of the blast hole so they are secure and away from any vehicle movements, tie to a rock or stick to ensure neatness and reduce risk of operators tripping over the downhole leads.
- > If a downline or primer is lost down the blast hole, notify the shotfirer, record the loss and reprime the blast hole.
- > Never remove a jammed primer by applying excessive force. Additional priming should be used if the original primer cannot be removed.

LOADING BULK EXPLOSIVES

When loading bulk explosives, the following general precautions should be taken:

- > Load the blast so the blast holes furthest from the access point are loaded first.
- > Liaise with the contractor as to which holes to load and in what sequence.

- > Charge the blast in a way that prevents damage to downlines and excessive spillage around the blast hole.
- > Regularly sample the product for quality and density. If the truck empties during the charging of a particular blast hole, identify the blast hole and make sure loading is completed before firing.
- > If working to a specific maximum instantaneous charge (MIC), ensure the truck operator does not exceed the specified MIC charge weights when loading bulk explosives.

Mobile processing unit (MPU) or mobile mixing unit (MMU)

The Australian Explosives Industry and Safety Group (AEISG) *Code of Practice Mobile Processing Units Edition 3 June 2014* provides guidance on MPU or MMUs.

The following general precautions should be taken while using MPU and MMUs:

- > A pre-start check should be conducted to make sure the vehicle is in sound condition and repair.
- > All workers operating the MPU/MMU must be competent to monitor any support equipment associated with the delivery of the explosives (e.g. pump pressure gauges, emergency shut off).
- > Product delivery hoses used for blow loading and emulsion must be anti-static. If a cyclone is used to direct product into the blast hole, it should be grounded at the blast hole and back of the MPU/MMU.
- > The operator should have full view of explosive delivery points or adequate communication with another operator who has a full view.
- > Vehicle access to the blast should be by a clearly defined access route designated by the shotfirer.
- > In areas of restricted visibility, a spotter should be used to control vehicle movements.
- > When working near the edge of the bench hazards must be identified and appropriate fall protection used.
- > Before leaving the mine site, any explosive residue should be cleaned from pump hoses and explosive mixing receptacles.

Pneumatic charging

Where pneumatic charging devices are used they must be effectively earthed.

Good practice for operation of a pneumatic charging is for antistatic footwear to be used and for the operators to remove their gloves and earth themselves before touching any electric detonator.

PREVENTION OF FLYROCK

Preventing fly rock is vitally important. The main causes of fly rock are:

- > insufficient stemming heights
- > inaccurate loading of explosives
- > the rise of explosives has not been checked. Bulk explosive has flowed into a cavity, fissure, joint voids or crack leading to overcharging
- > actual burden design not known due to not using technology such as face profiling and bore tracking
- > blast holes have deviated when being drilled and have come closer together than designed resulting in a portion of the blast being overcharged
- > blast hole deviation is such that burden is reduced leading to part or all of the blast hole being overcharged. Blast hole deviation can reduce the burden along the whole blast hole not just the bottom (the use of a bore tracker is recommended if this poses an issue in conjunction with face profiling)
- > poor delay sequences lead to an excessive delay period between adjacent blast holes resulting in reduced burdens being created during the blasting operation leading to fly rock

- > the amount and/or type of explosives placed in the blast hole is not suitable for the rock type leading to overcharging
- > a geological anomaly in the rock formation, such as a dyke, creates a band of weathered weaker rock in front of a charged blast hole which can lead to overcharging. Geological anomalies can be difficult to identify on the face as they may look similar to the surrounding rock. Visual assessment of the face prior to blast design will assist in the understanding of where any potential geological anomalies may be located.

Rock around the collar of a blast hole may be fractured by previous blasting of the benches above (pre-conditioning). Surveying the face and obtaining as much information as possible on the geology is important when developing the blast design. It is also important to verify this information prior to charging the blast. Careful adherence to the charging details contained in the blast design should lead to successful incident free blasting. If any site conditions change after the blast has been designed then their impact should be assessed, noted and the design modified if required. The quantity of explosives used and the methods of use should be managed to reduce the risk of people and equipment being exposed to fly rock and any impact on the environment.

Shotfirers should:

- > frequently check (every metre) the rise of explosives in the blast hole
- > visually check the alignment (azimuth) and inclination of every blast hole and compare them with the design
- > carefully consider any deviations
- > consider reprofiling where a slip has occurred after the initial profile was completed
- > include a delay sequence plan with the blast information so excessive delay periods can be easily identified
- > check the powder factor for the rock type to calculate the quantity of explosives (may wish to compare with previous successful blasts)
- > examine other site faces for evidence of dykes
- > consult with the driller and check the driller's log for evidence of geological anomalies (e.g. voids, dykes, clay seams, cavities, fissures, joint voids or cracks). Also check for changes in the rate of penetration of the drill string (if it increases it can be due to weaker rock)
- > communicate the blast plan with all relevant staff and contractors to ensure all personnel understand MIC, safety and blast parameters prior to blasting.

SLEEP TIME IN BLASTHOLES

Managing the sleep time of an explosive is important because they can deteriorate (desensitise) in unfavourable conditions such as excessive heat or cold, humidity and dynamic groundwater. Product deterioration may result in a charge, or part of a charge, failing to explode or misfiring. Explosives should be charged and fired at the earliest practicable time.

At any time when a blast is being slept, guards should be posted and remain in place until firing. This protocol should be included in the ECP.

CHARGING DURING SHIFT CHANGES

When charging is being undertaken during shift changes a written procedure should be in place for communication between the shifts. Information about charging and blasted locations, blast holes loaded and any unique hazards or unusual circumstances associated with the blast should be shared.



PERSONAL PROTECTIVE EQUIPMENT (PPE)

When handling or using explosives, the potential hazards must be identified and suitable PPE provided and worn. Technical data sheets (TDS) and safety data sheets (SDS) for the products being used will outline PPE requirements. ANFO-based products include diesel and can increase wear of clothing, boots etc.

ACTIVITIES IN PROXIMITY

Section 7.2 of AS 2187.2 requires that there be no activity undertaken within the proximity of the blast that could expose explosives or explosives manufacturing/transport vehicles to excessive or prolonged friction, impact shock or heat. This includes smoking, naked flames or operation of machinery. Unauthorised workers and machinery not involved in the blasting operation should be removed to a safe distance from the area.

VEHICLES ON NON-ELECTRIC BLAST

Where vehicles are used at non-electric blasts there is a risk of a premature explosion or misfire if the vehicles run over detonators or damage the signal tube. Vehicle access to the blast should be by a clearly defined access route. Where there is restricted visibility a spotter should be used to control vehicle movements.

SIGNS

Charging areas should be clearly marked with appropriate warning signs. Where charged blast holes will be left to sleep overnight suitable guarding, barricades, warning signs and lighting should be used. Approaching vehicles and people need to be able to clearly identify the charge area.

COMMUNICATION DEVICES

When using electric initiation, it is possible for the blasting circuit to be energised by the electric field produced by items such as radio transmitters, mobile telephones and two-way radios. Such devices should never be carried while holding or connecting electric explosives. Safe distances for electric detonators subject to radio frequency should be determined.

6.5.3 STEMMING

Avoid damaging the downhole lead connected to the primer during the placing of stemming material. The following precautions should be taken:

- > Make sure the blast hole has been loaded with explosives to the correct charge length.
- > Check the tension on the downlines to determine whether the primers are in the product.
- > Check the stemming material is of a suitable quality (and size) and does not contain large fragments of rock that may cause damage to downlines.
- > Leave blast holes charged with gassed bulk explosives un-stemmed for the recommended time to allow for gas bubble expansion.
- > Stem all loaded blast holes prior to the end of the shift. In cases where this is not possible consider blocking the blast hole with (e.g. a gasbag).
- > Avoid tamping of stemming, this activity has a risk of damaging the downhole lead.
- > If a mobile plant (skid steer/front end loader) is used to assist in stemming applications, ensure a spotter is used to delineate the travel path away from downhole leads.

TAMPING RODS

Only wooden or other non-metallic rods should be used when tamping to prevent the possibility of creating a spark. Make sure the downlines connected to the primer are not damaged during the tamping process. A primer should never be tamped due to the risk of explosion caused by impact.

STEMMING HOPPERS

Where mobile equipment is used for the loading of stemming into charged blast holes, the operator should have good visibility. If not, a spotter should be used. Care should be taken not to damage downlines when stemming.

Stemming should be completed as soon as possible after the blast hole is loaded.

6.5.4 INITIATION

Consider the following procedures when connecting blasts using non-electric, detonating cord or electric initiated systems:

- > Workers carrying out the hook-up should have a connection or tie-up plan.
- > After connecting the surface leads they should be checked to confirm correct sequencing. The shotfirer is ultimately responsible for the hook-up and should personally check the connections before firing.
- > The final stages of the blasting process (e.g. connecting the lead-in-line) should not be completed until the blast area is cleared and blast guards are in position.
- > In the event of a possible thunderstorm developing, the person in charge must assess the proximity of the storm and decide whether to initiate or not. If a thunderstorm approaches any handling or preparation of explosives must stop and all people evacuated in accordance with site procedures.
- > Where a blast is not going to be fired, the shotfirer should, if safe to do so, disconnect the control row before evacuating.

NON-ELECTRIC FIRING

Procedures should be followed that provide a safe system of hook-up of non-electric initiation systems. The systems can be signal tube based, detonating cord based or a combination. The use of all systems should be in accordance with the manufacturer's recommendations. Particular care should be taken when mixing signal tube and detonating cord systems.

ELECTRONIC FIRING

In the event the site uses electronic initiation practises to increase control of environmental management associated with blasting the following should be considered before blasting is undertaken:

- > Ensure sufficient cable wire length from the blast site to the place of initiation to maintain safety and reduce risk of operators becoming endangered by any potential flyrock.
- > Mobile phones should not be used as some frequencies can affect the computer chip hardware of the detonator.
- > Check that all detonators are communicating with the blast box before firing.
- > Ensure all personnel are safe behind blast guards before booting energy into the detonators (this may take up to two to three minutes dependant on the number of detonators in the sequence).
- > Wait the specified manufacturer's time before entering the blast zone to inspect for potential misfires. (Different electronic detonators have different timings that energy is released from the detonator after firing if a detonator has misfired.)



ELECTRIC FIRING

Electric detonators are susceptible to accidental initiation by sources of stray electricity. To reduce the risk of accidental ignition the following controls should be applied:

- > Keep lead wires, connectors and fittings shorted (twisted) until immediately before use.
- > Do not use electric detonators near power lines or other potential sources of electric current.
- > Stop all surface charging operations if an electrical storm is imminent. Lightning detector devices can be used to track storms and lightning strikes, giving greater determination of whether surface charging operations should cease. Select an appropriate detector for the type of charging operation, and use in accordance with site and manufacturer's instructions.
- > Keep detonators clear of the ground until charging starts.
- > Never hold an electronic delay detonator while it is being tested or programmed.
- > Do not use plastic liners in blast holes unless they are permanently conductive.

Where any class 1 substance is to be fired using an electrical system other than those firing systems (initiated only by electrical currents modulated to specific waveforms or pulse sequences) ensure that the area within 2 m of the uninsulated portion of the electrical firing system is not subject to stray electrical currents of more than 60 mA. (This will depend on the type of detonators used.)

Consider methods to protect circuits from electromagnetic radiation when undertaking any electric firing in close proximity to radio masts or antennae, mobile phone towers, communications towers or satellite dishes. If these situations exist the use of non-electric initiation systems should be considered.

Before connecting the firing circuit, it should be checked for resistance and continuity. It is possible an explosion might occur when testing. Therefore, appropriate hazard controls, including clearing the blasting area and choosing a safe location for testing, must be in place. The shotfirer should make sure the circuit tester is maintained in correct working order.

BLASTFIRING CABLE

Where a firing cable is used to initiate a blast, the shotfirer should make sure the cable is adequately protected and insulated for the conditions under which the blasting is to be carried out. Adequate precautions are essential to prevent the cable from coming into contact with electrical installations, metal objects and areas where possible damage can be caused to the insulating cover. Keep the cable short-circuited at each end during the charging operation and at the power end while the leads from the detonators are being connected. The short circuit at the power end should not be opened for connection to the source power until the blasting area is clear of people. As soon as the blast has been fired the short circuit should be re-established by physical disconnection from the exploder.

EXPLODERS

Only exploders capable of storing or generating the electrical energy required to reliably initiate electric detonators should be used. They should be carefully handled and regularly tested to ensure they perform reliably.

It is critical that explosives are not:

- > subjected to any impact or pressure shock that could result in an unintended explosion or fire
- > exposed to any ignition source that may release spark energy in a way that could result in an unintended explosion or fire

- > exposed to any ignition source capable of generating heat or fire where that could result in an unintended explosion or fire
- > exposed to the build-up of static electrical charges that could result in an unintended explosion or fire.

6.5.5 FIRING

BLAST EXCLUSION ZONE

The shotfirer should determine the blast exclusion zone and the location of guards by undertaking a risk assessment which considers any technical concerns or known hazards in the blast.

AS 2187.2 Appendix L, notes at L3 in relation to the size of the exclusion zone that “the distance required to limit air blast overpressure to tolerable levels can be estimated, but the distance for fly rock can be difficult to predict and can vary from site to site.” Therefore, determining the size of the zone, in many cases is done through extensive consultation with other stakeholders. The standard also notes that “the zone may be larger than the calculated size to make use of control points such as transport junctions, or elevated areas that provide clear lines of observation”.

WARNING PROCEDURES

The person in charge of the blast should ensure everyone not specifically authorised by the shotfirer to be in the blast area is excluded. Typically, this is achieved by using the following methods:

- a. Information is displayed, visible from all access points to the blast area that warns that a blast is being fired and entry is prohibited.
- b. One minute before firing, a distinctive warning sound is generated that is of sufficient volume to be heard throughout the zone, and at all points that are 5 m from the outer side of the perimeter of the zone, by a person with normal hearing.
- c. a visual check is made of the blast area immediately before firing to ensure that all people not directly involved have been evacuated.

External parties

Pre-notify external parties if necessary before conducting blasts. External parties may include adjoining properties, residences, specific sensitive receptors (e.g. schools, hospitals and nursing homes) or the general public.

Withdrawal of people

People in the vicinity of the blast area must be warned and withdrawn to a safe location outside the blast exclusion zone before firing the blast. They should not return until the all clear signal is given by the shotfirer. Everyone involved in the blast should be able to reach a predetermined safe position before firing.

A visual check of the blast exclusion zone should be undertaken before firing.

Signs

Information must be displayed that warns people there will be a blast and that entry is prohibited. Any signs must be clearly visible and written in such a way that people can clearly understand them.

Audible warning device

An audible warning device must be used to indicate a blast is going to take place. The device must produce a sound that is clearly identifiable from any other sound that might be used for warning or operational signals on the site. It must be loud enough to be heard throughout the blast area.

Radio signal

Where radios are also used to give an audible warning signal, everyone onsite should clearly understand the signal.

Where there is more than one radio channel used on a site, select a radio channel that is always used for blasting. The warning signal should be broadcast simultaneously on all channels where there are users of other channels in the blast locality.

Preventing access to the blast exclusion zone

Adequate roadblocks and guards (sentries) should be placed at any road or access point into the blast exclusion zone during the firing and until the all clear is given by the shotfirer.

BLAST MONITORING

Where blasting is conducted near buildings or structures, ground vibration and air over pressure monitoring should be undertaken.

6.6 POST-FIRING

6.6.1 POST-FIRING INSPECTION

A post-firing inspection should be undertaken by the shotfirer. Before entering the blast area, sufficient time must be allowed for dust and fumes to clear. Early re-entry may result in illness from inhalation of toxic gases and post-blast fumes.

Dust and fumes can also reduce visibility and result in collisions, falling, tripping or inability to detect unstable rock.

Where a blast has been initiated by electric detonators, the firing cable should be disconnected from the exploder immediately after firing and before the post-firing inspection. The ends of the firing cable should be short-circuited together and the key removed from the exploder.

The purpose of a post-firing inspection is to confirm conditions in the area of the blast are safe for work to restart. In particular, the shotfirer should look for evidence of:

Unstable ground: The ground vibration and ground stress redistribution resulting from blasts can loosen rock around walls some distance from the blast site.

Areas that were stable before a blast can become unsafe or collapse after a blast. Falls of ground can pose a serious threat to the safety of any workers in the area. People undertaking the post-blast inspection should approach the blast area with caution, avoiding the toe and crest of the face. If possible inspect the blast muck-pile from the bench below or to the side.

Misfires or burning explosives: If explosives have misfired or are burning there is a clear danger of additional detonations with the associated risks of blast damage and fly rock. Misfired explosives are often difficult to detect and accidental initiation in a confined location can cause serious injury or death. It is essential to thoroughly look for any signs of misfired detonators, detonating cord and burning explosives during the post-firing inspection and all subsequent digging operations. People in the area should immediately return to a designated safe zone if misfires or burning explosives are discovered. The all clear should not be given and all guards, barricades and signs should stay in place. The shotfirer should inform the mine manager of the situation immediately.

Only after the post-firing inspection has been completed and the area has been confirmed as safe should the all clear can be given and barricades, cautionary signs and guards removed.

The shotfirer should ensure any misfired explosives are identified and treated according to the site procedures.

6.6.2 PREVENTION AND MANAGEMENT OF POST-FIRING FUMES

Blasting operations can sometimes cause toxic gases including oxides of nitrogen, ammonia, nitric acid, carbon monoxide and carbon dioxide to be released into the atmosphere in significant quantities. These gases are often referred to as blast fumes and exposure to even quite low concentrations can pose a serious health risk. Nitrogen dioxide is visible as a reddish-brown colour while the other gases are not visible.

The safety management system should include the different control phases for blast fumes that include:

- > prevention: how to prevent or minimise blast fumes
- > management of fumes: where blast fumes extend beyond the blast exclusion zone
- > management of an exposure: for when people are exposed to blast fumes.

Mining operations should include control measures in their ECP and emergency control plan.

PREVENTION

There is a strong correlation between wet ground and the production of excessive blast fumes. As well as water, known causes for the generation of blast fumes are:

- > incorrect fuel to oxygen ratio
- > product pre-compression
- > insufficient priming
- > acidic soils
- > presence of pyrite
- > incorrect product formulation.

Blast fumes can be reduced if:

- > the explosive product selected is correct for the conditions
- > blast holes are dewatered before loading
- > sleep times are kept to the minimum time recommended by the manufacturer.

An understanding and application of meteorology (i.e. weather conditions, wind speed and direction and stability classes) and gas cloud distributions will enable calculation of how long a blast gas plume will take to reach a point of interest such as a crib room, workshop, office or house.*

Such understanding and application also helps in determining the dispersion of the gas plume, how far it will spread sideways and how the gas concentration will change with distance. Anyone developing prevention and emergency management plans should understand the gas toxicology and the exposure standards of a gas (i.e. nitrogen dioxide), particularly high concentration exposures over relatively short periods.

MANAGEMENT OF FUMES

Before a gas plume is created it is important to have a system for managing a potential incident. The system should include information on wind speed and direction and on whether there is a gas-tight shelter nearby. Communication systems and monitors to record concentrations of toxic fumes should also be in place.

* Buildings should not be used as shelters unless they have been assessed by competent people as safe havens



MANAGEMENT OF AN EXPOSURE

Exposure to nitrogen dioxide can result in delayed health effects that may be life threatening even though the exposed person may initially appear relatively unaffected. For this reason, people who have been exposed to nitrogen dioxide should undergo an immediate medical assessment and a continued period of observation on the advice of the treating doctor.

Safety data sheets for the types of products being used must be readily available to everyone involved in the blasting process (clause 344 WHS Regulation).

See Queensland Department of Employment, Economic Development and Innovation, Explosives Inspectorate, Safety Alert No. 44 V2, 15 March 2011 *Prevention and management of blast fumes* for more information.

6.6.3 MISFIRES

The site should have a written procedure that provides a safe system of entry and inspection for misfires and their treatment including the methods used for detection.

Mining operations should address the procedure to find, recover and detonate or recover misfired explosives. Records must be kept of all actions taken to recover misfires.

DETERMINATION OF MISFIRES

Methods used to determine if a misfire has occurred are based on many factors, including appropriate training, standard operating procedures and guidance from standards (e.g. AS 2187.2 – 2006 *Explosives – Storage and use*). There are certain events that may indicate a misfire has occurred including:

- > If using safety fuse, the number of blasts counted is less than the number of blast holes loaded or a disagreement on the count of blasts fired.
- > If damaged safety fuse, detonating cord, lead wires or unfired signal tube are exposed in a blast hole that has been fired.
- > Evidence of cut-offs, butts or remaining portions of blast holes that are suspected of containing explosives.
- > During excavation of the blasted ground uninitiated or residual explosives are found.
- > The visual identification of increased toe or oversize within a muck pile.
- > The visual identification that a series of surface detonators have not initiated throughout the firing sequence.

MISFIRE TREATMENT

Having located a misfire, do not attempt to drill into the charged blast hole. A hazard identification and risk assessment should be undertaken to determine the safe treatment method. A misfire among a number of charges may cause excessive rock scatter when fired because the successful blasts have relieved the overburden. Adequate extra cover should be used in such cases. If a misfire is required to be retrieved, it is recommended to use a front-end loader for retrieval instead of an excavator, if under some circumstance the charge detonates the loader bucket will aid in deflecting rock away from the operator whereby the use of an excavator has an increased risk of the detonated fragments entering the excavator cab because of the positioning of the bucket.

Removal of stemming and re-priming

Where a blast hole has completely misfired, the stemming may be removed by either applying water under pressure or by compressed air and water through a length of antistatic hose. No metal fitting should be within the blast hole. Where water under pressure (or water and air pressure) is not available the stemming may be sludged out using water and a wooden or other approved implement.

Compressed air alone should not be used. When the stemming has been removed, a fresh priming cartridge may be inserted and the blast hole again stemmed and fired. Artificial burden or cover should be placed around and over the hole to prevent fly rock.

If a misfire contains ANFO or slurry or any other explosive rapidly destroyed by water, such explosive may be sludged out down to the primer using the procedure described for removal of stemming. The slurry explosive washed out should be treated as deteriorated explosives and dealt with as detailed in section 8.21. The blast hole should then be reprimed and fired to initiate the original primer and any residual explosives. Do not remove a primer charge from a blast hole.

Relieving blast hole misfire treatment

Where it is not possible to explode a misfire by refiring, a relieving blast hole should be drilled parallel to the original blast hole then charged and initiated as follows:

- > Mark the misfired blast hole clearly. When the misfired blast hole is 50 mm or less in diameter and less than 3 m in length, do not drill the relieving blast hole closer than 600 mm to the nearest point of the misfired blast hole.
- > When the misfired blast hole is larger or longer than 50 mm and 3 m respectively, increase the distance between the misfired blast hole and the relieving blast hole so the misfired charge will not be drilled into.
- > When an electric detonator is involved, first short-circuit the detonator lead wires and then secure to allow recovery of the detonator after a relieving blast hole has been fired.

All explosives recovered from misfired blast holes should be collected and disposed of as detailed in section 6.6.6.

Pre-drilling precautions

No blast hole should be drilled in any face or bench until the explosive has been thoroughly cleaned and washed down within a safe distance of the misfired blast hole. Any cut-offs or sub-drill should be examined to make sure they do not contain explosives. Sub-drill holes should then be plugged with a wooden plug (or stemmed). If examination reveals explosives, the cut-offs or sub-drill holes should be primed and fired and the pre-drilling precautions above taken again.

Misfire workers

Where a misfired charge is identified, the shotfirer should ensure no-one approaches for 15 minutes in the case of an electrically (signal tube/electronic) fired charge. For a blast fired by safety fuse the re-entry time is 30 minutes. The shotfirer should then safely dispose of the malfunctioning charge.

The shotfirer may have an experienced person to assist. All other people must be kept well clear of the area.

LOADING OUT A KNOWN MISFIRE

Before retrieving misfired material, a written hazard identification and risk assessment should be completed by competent people. The hazard identification and risk assessment should take into account the site blasting procedures. The hazard identification and risk assessment should identify key areas, for example:

- > The excavator involved may need to be provided with additional protection for the operator. This depends on the properties of the material involved.
- > How the mobile plant operator can be alerted to the presence of suspect material (e.g. through the use of CCTV or other suitable means of isolation).
- > How blast holes involved in the misfire can be located in the rock pile. Survey equipment may be used that can more accurately define the hazardous area. Flags, bunting or warning notices may be needed to mark the areas identified.



Accidental initiation can occur while the mobile plant operator recovers explosive material by:

- > the bucket of the mobile plant striking the explosive material during excavating
- > rock falling and striking the explosive material
- > the mobile plant running over the explosive material
- > movement of rock in the bucket while transportation is taking place
- > tipping the rock out of the bucket at the search site.

All explosive materials have a sensitivity, some greater than others. Heat, pressure and friction can initiate the explosives or detonators especially if they are damaged. When misfired charges are found the shotfirer must safely dispose of them.

6.6.4 RECORDS

Blasting records including all key parameters such as blast hole diameter, burden and spacing, depth of hole drilled, maximum instantaneous charge (MIC) weights to be used, total quantities of explosive required and used, tie-in patterns and number of delays should be documented. A key component of shot firing is also ensuring that the shotfirer has account for all explosives (IE & HE) used throughout a blasting event. A detailed explosive reconciliation should be undertaken before and after a shot is fired to ensure all explosives are accounted for.

6.6.5 REPORTING REQUIREMENTS

Incidents relating to loss, theft, suspicious activity that threatens security, or serious incidents involving explosives or explosive precursors at mines must be reported under the Explosives Regulation.

A licence holder under the *Explosives Act 2003* must immediately notify the Resources Regulator of the loss, theft (including attempted theft or any suspicious activity that threatens security) of explosives or explosive precursors at a mine. Mine operators and/or managers must also notify other relevant authorities, including NSW Police and SafeWork NSW.

A misfire or unplanned explosion of an explosive or explosive precursor (other than where the misfired explosive can be fired without any significant risk to a person) must be reported to the Resources Regulator as a high potential incident.

If an ejection of rock from blasting falls outside the exclusion zone, it is to be reported to the Resources Regulator as a dangerous incident.

6.6.6 DISPOSAL OF SURPLUS AND DEFECTIVE EXPLOSIVES AND PACKAGING

The disposal of explosives is considered to be an inherently hazardous task. There have been several fatalities and serious injuries where people have attempted to dispose of explosives without being trained, competent and experienced.

EXPLOSIVES NO LONGER REQUIRED

Explosives no longer required should be returned to the supplier. In the event whereby they cannot be returned to the supplier, disposal methods must be in accordance with Section 11 of AS 2187 and the supplier's recommendations. If unsure of requirements it is advised to gain advice from a suitable explosives provider or SafeWork NSW.

EXPLOSIVES FOUND WHILE LOADING

Treat any explosives found while excavating as live. If a misfire is found while loading out from a muck pile or if an operator sees live explosive in a face it is important to stop work and notify mine management immediately and secure the area. Notify staff that the area is to be evacuated until an investigation can take place. In the event ANFO is found to be in a muck pile or face, it may be possible to reach the affected area with a cannon of a water truck to desensitise the product. Again it is advised that professional personnel undertake a risk assessment and inspection before any remediation activities are undertaken.

EXPLOSIVES PACKAGING

Empty explosive packaging should be checked to ensure no explosive remains hidden or lodged within any packaging before disposal. Labels should be clearly marked so there is no uncertainty of the packaging contents.

DISPOSAL OF EMPTY EXPLOSIVE CASES

Where burning empty cases following a blast, they should be taken away from the blast site to a secure place. After checking no explosive remains hidden or lodged in the case and any residual content is removed, burn them under controlled conditions. The site should be cleared and secured while the burning takes place. The area should be checked after burning to make sure there is nothing left of the cases.

Recycling of empty cases is also considered an acceptable practice provided the cases have been confirmed as having no residual content and the cases have been blanked (i.e. placards painted over or removed).

6.7 MINIMISING BLAST DAMAGE

Inappropriate blasting practices can result in substantial damage to the surrounding rock mass and final slopes. This damage can take the form of:

- > loose rocks being left on slope faces and batter crests.
- > In the event that the shot is trying to push too much burden, excessive back break may result, therefore disrupting the integrity of the rock behind the shot and preconditioning a future face to be blasted.
- > a cumulative reduction in the strength of rock mass in which the slope is developed. In particular, the shear strength of structural defects could be reduced.

To avoid these potential issues presenting themselves onsite, implementation of standardised drilling and blasting practices based on well-founded and recognised blast design procedures, which are appropriate to the ground conditions at the site will assist.

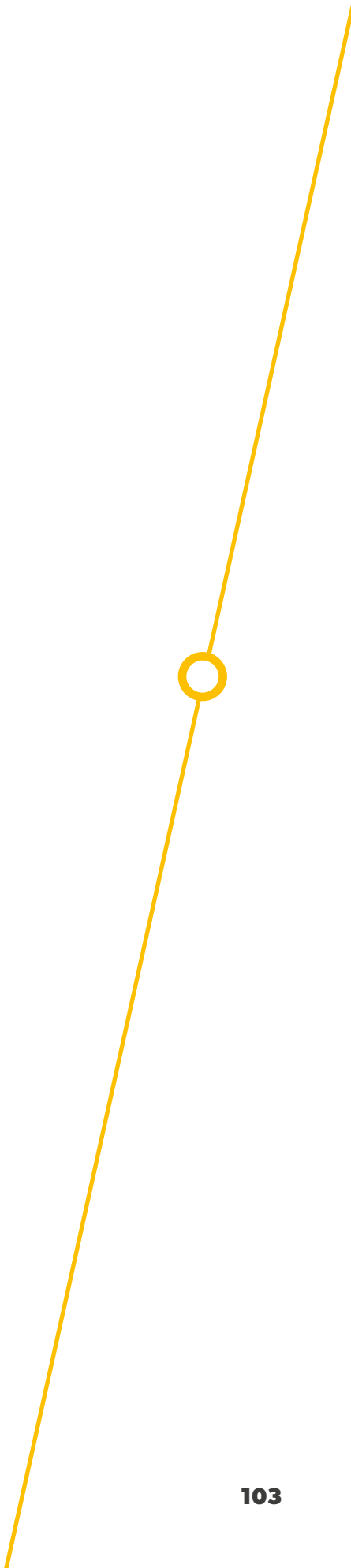

07

PART C

Controlling ground instability in excavations

IN THIS SECTION:

- 7.1 Planning and design**
- 7.2 Excavation rules**
- 7.3 Excavation control and scaling**
- 7.4 Slope movement monitoring programs**
- 7.5 Remedial measures**
- 7.6 Historic underground workings**
- 7.7 Working near slopes**

To manage the risk of ground instability during excavation, have suitable procedures in place for excavation and monitoring of slopes.

This section describes how to:

- > scale and control excavations to prevent rockfall or slope instability
- > monitor slopes to detect any instability
- > prevent or highlight ground instability

7.1 PLANNING AND DESIGN

Before any excavation begins, a competent person should undertake an assessment of the site ground conditions to determine all factors likely to affect the stability of the ground and the limitations that should be imposed on the excavation site design (refer to Part B, Section 3).

This assessment should be documented. The mine should have a well-considered and practical mine plan. The assessment should be reviewed and revised when necessary after a material change has occurred in the ground conditions or the excavation methods. Effective ground control relies on geotechnical information obtained at different stages of the life of the site including planning and design, implementation of the design and day-to-day operations such as surveying, installation, maintenance and inspections.

Following assessment of ground conditions, a design should be prepared setting out the measures to control ground instability. Where an existing design has already been proven, it may be used as the basis for the design of a new excavation if the ground conditions at both sites are not significantly different. This requires ongoing assessment of the ground conditions as incremental changes can occur over time, resulting in different ground conditions from those originally excavated.

During planning and design, there is usually a relative lack of data available when the slope design is first developed. It is therefore essential that geotechnical information obtained during operations is consolidated with information in the geotechnical model. This should be continually used to assess the suitability of the slope design in relation to ground stability and, if required, adjust site parameters accordingly.

Implementing the design typically involves considering suitable ground control strategies, such as minimising unnecessary damage to slopes during blasting, excavation control and scaling and installation of ground support and reinforcement. Refer to Section 3 for more information on excavation design.

7.2 EXCAVATION RULES

As a part of the ground or strata PHMP, excavation rules should be reviewed and refreshed regularly, and include:

- > the way excavation activities should be carried out, specifying the type and reach of excavators
- > the physical dimensions of the excavation including slope, height of faces, width of benches, position of catch-berms and gradient, position and protection of access ramps
- > the way in which material should be removed from the excavation
- > the sequence in which material should be removed

- > maintenance of faces (including scaling of crest lines and so on)
- > the nature and frequency of supervision required
- > response to defects.

These rules are essential for the management of excavations. They are practical measures required to keep excavations and the people working in and around them safe.

7.3 EXCAVATION CONTROL AND SCALING

Adequate excavation control and scaling of faces (and selection of the equipment to be used to achieve the desired standards) are critical elements in achieving and maintaining safe slopes.

Matching the blast design, muck pile position and heights with site equipment will allow safe and efficient removal of blasted material.

In soils including weak and weathered rock, batters can be excavated by free digging using hydraulic excavators or in the event of a gentle slope a bulldozer might be able to rip and push. It is critical that slopes are not undercut, allowing the slope to be built steeper than designed. This could result in instability and potential overtopping failures resulting.

Adequate surface water runoff control measures should be implemented on the benches separating the batters to minimise water infiltration and batter degradation.

In strong, unweathered resources, drilling and blasting is needed to fragment the rock mass before the final preparation of the slope. Care should be taken to prevent over digging of the face, particularly where there is blast damage or fractured rock.

Scaling of the batter crest and face following excavation is an important component of the implementation of the design. Scaling is intended to remove loose rocks, blocks and slabs that may form rock falls or small failures. Scaling also helps preserve the catch capacity of benches needed to retain loose rock material falling (rilling/ravelling) from above. In soils and weak and weathered rock, experienced mobile plant operators can construct slopes with smooth surfaces so scaling is not generally required.

Scaling from the bench above is normally done by chaining the face using a large chain. The chain can be dragged along the face by a dozer or excavator.

Scaling from the bench below is generally performed by an excavator configured as a backhoe. Most manufacturers offer specialised units equipped with long booms holding small buckets or rock picks.

The debris accumulated at the toe of the batter after scaling should be removed before access to the toe is lost. This will ensure adequate catchment volume on the safety bench is maintained. Supplementary bench cleaning will depend on access and the service life of the slope. Periodic bench inspections should identify sections that require cleaning.

7.3.1 MOBILE PLANT WORKING ON FACES

Faces that have potential for instability should be worked within the reach height of the equipment used, whether they are working in sand or hard rock. Typically, wheel loaders can reach 6-8 m and excavators 9-12 m. Larger mining shovels (120 tonne or more) are capable of reaching 18-20 m, depending on how they are used. If mobile plant is at risk of being engulfed in a face collapse, a trench or rock trap should be used to maintain a safe operating distance and to ensure a void to catch potential rock fall volumes has been dug.

Good blasting practice will result in muck piles that can extend the reach of the excavating equipment. (Refer to Figure 34, 35 and 36).

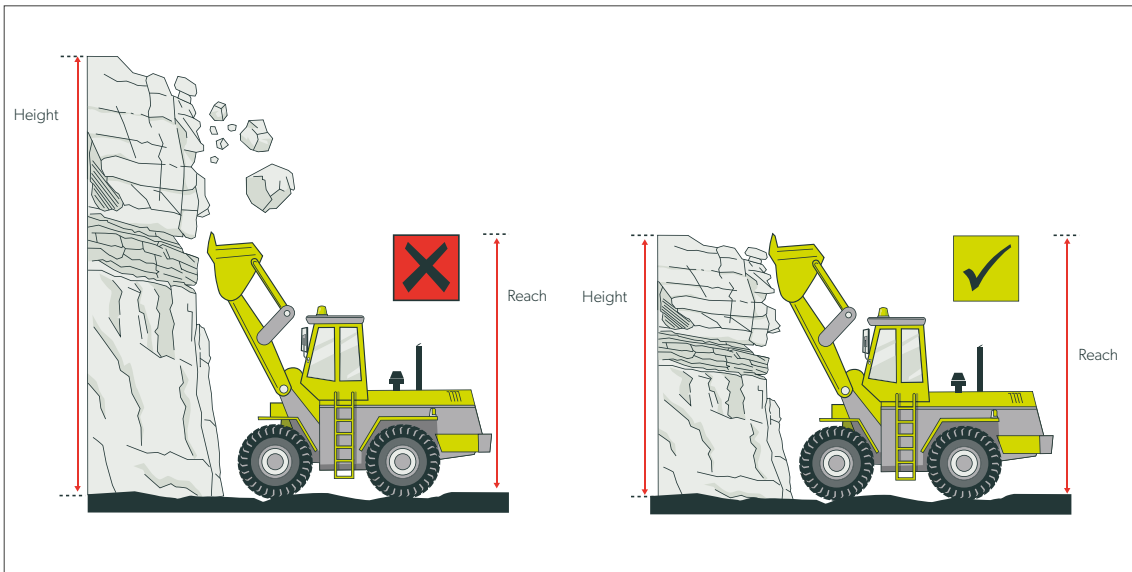

Figure 34. When working the face, the face height should not exceed the reach of the loader being used.

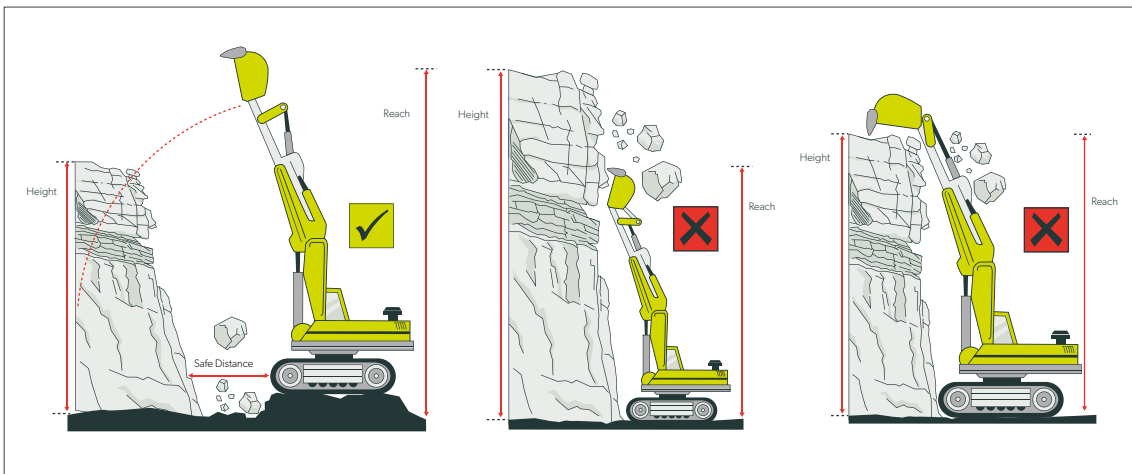

Figure 35. When working the face, the face height should not exceed the reach of the excavator being used.

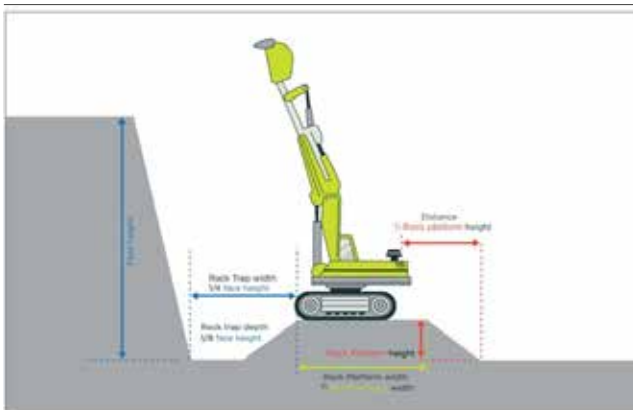

Figure 36. Face height can be extended where a methodology of controlling the hazards on the face is readily available e.g. excavator sitting on a muck pile, thus increasing the scaling height or excavator scaling from above, or using chains. (This applies to both Figures 35 and 36).

7.3.2 POST EXCAVATION INSPECTION OF BLASTED SECTIONS³

When the excavator reaches the batter face following a blast, the designed toe and crest should be achieved and no blast-induced damage should be visible on the face. After excavation is completed the face should be inspected and analysed for excessive over break. The damage should be classified into the following categories to help guide design refinement:

- > No visible damage: joints tight, teeth marks in face, no loose material present, half-barrels visible when pre-splitting and a well-defined toe and crest.
- > Slight damage: joints opened up, crest loss <1 metre, few half-barrels visible when pre-splitting, excavation possible for 1 metre beyond designed batter location.
- > Moderate damage: blocks dislodged, crest loss 1-3 metres, excavation possible for 1-3 metres beyond designed limit.
- > Severe damage: face shattered, blocks dislodged and rotated, excavation possible for more than 3 metres from designed limit.

A detailed record should be made of the post excavation performance of the batter face.

Operators should be trained in the identification and control of excavation hazards and appropriate levels of supervision of workers should also be in place to ensure that agreed controls are implemented and maintained.

7.3.3 INDICATIONS OF FAILURE⁴

Even the most carefully designed slopes may be subject to instability. Some of the more common indications of failure are listed below.

TENSION CRACKS

Cracks forming at the top of a slope are an obvious sign of instability. Cracks form when slope material has moved toward the floor. Since this displacement cannot be detected from the floor, it is extremely important to frequently inspect the crests of slopes above active work sites. Safe access to the regions immediately above the active excavation should be always maintained.

Frequent inspections may be necessary during heavy rain and after large blasts.

The simplest method for monitoring tension cracks is to spray paint or flag the ends so that new cracks or propagation along existing cracks can be easily identified on subsequent inspections. Measurement of tension cracks may also be as simple as driving two stakes on either side of the crack and using a survey tape to measure the separations (see figure 37). It is important to divert any surface waters away from any tension cracks to limit the amount of water ingress entering the crack. Moisture can swell dispersive soils and increase crack width and risk of further failure of slopes.

³ Beale G. (2009) Guidelines for Open Pit Slope Design, Eds. John Read and Peter Stacey, CSIRO Publishing

⁴ Girard, J. M. (September 2012). Assessing and monitoring open pit mine highwalls. WA, Australia. Sourced from www.cdc.gov/niosh/mining



Figure 37. Measuring a ground crack that has opened up

ESCARPMENTS

Escarments, also known as scarps, are very steep slopes that occur where material has moved down in a vertical or nearly vertical fashion. The material that has moved vertically and the face of the escarpment may be unstable and should be monitored accordingly.

ABNORMAL WATER FLOWS

Sudden changes in rainfall or water flow may also precede slope failures. Intense rain fall events are one of the most obvious examples of increased water flow that may have adverse effects on slopes. However, changes in steady flow from dewatering wells or unexplained changes in piezometer readings may also indicate subsurface movement that has cut through a perched water table or intersected a water bearing structure. Changes in water pressure resulting from the blockage of drain channels can also trigger slope failures.

Water can also penetrate fractures and accelerate weathering processes. Freeze-thaw cycles cause expansion of water-filled joints and loosen slope material. Increased scaling may be necessary during cold weather.

CREEP OR SLOW SUBSURFACE MOVEMENT

Bulging material or “terraces” appearing on a slope generally indicate creep or slow subsurface movement of the slope. These are indications that the ground is saturated and expands, then dries and contracts, causing the ground to move downhill. Other creep indicators can be determined by looking at vegetation in the area. While most quarries or mines do not have vegetation on slope faces, the movement of trees at the crest of a slope can indicate instability.

RUBBLE AT THE TOE

Fresh rubble at the toe of a slope or on the floor of the excavation is an obvious indicator that instability has occurred. It must be determined which portion of the slope failed and whether more material may fail. One of the most dangerous situations to occur is an overhang. If workers are not aware that a portion of the material below them has failed, they may unwittingly venture out onto an unsupported ledge. Remedial measures such as scaling, supporting, or blasting the overhang or other hazardous rock may be necessary.

7.4 SLOPE MOVEMENT MONITORING PROGRAMS

Slope monitoring may be needed to detect instability at an early, non-critical stage to allow for the initiation of safety measures. Monitoring after the fact does little to undo the damage caused by unexpected failures.

The collection, analysis and interpretation of relevant geotechnical data, including the monitoring of openings and excavations, must be considered when developing control measures for the ground or strata failure PHMP.

Geotechnical characteristics of rock between workings must also be considered when developing a PHMP for inundation or inrush of any substance (if that is a principal hazard at the mine).

The purpose of a slope movement monitoring program is to:

- > maintain safe operational practices for the protection of workers, equipment and facilities
- > provide warning of instability so action can be taken to minimise the impact of slope movement
- > provide crucial geotechnical information to analyse the slope failure mechanism and design the appropriate corrective measures.

Planning a slope movement monitoring program should involve the following steps:

- > definition of site conditions
- > prediction of all potential mechanisms that could control instability
- > determination of parameters to be monitored and potential magnitude
- > establishment of suitable monitoring systems, including instrumentation and location
- > formulation of measurement procedures, including frequency, data collection, processing, interpretation and reporting
- > assignment of tasks for design, construction and operation of systems
- > planning of regular calibration and maintenance
- > establishment of trigger action response plans (TARPs) and associated accountabilities for action to minimise impacts of slope movement.

Monitoring methods for slopes can be surface and subsurface, qualitative and quantitative. All have their place in specific environments and are often related to the potential failure size. The selection of the most appropriate technique depends on site-specific conditions.

Regardless of the technique used, if there is an adequate level of monitoring and a good understanding of the ground conditions, the onset of major slope failure can be detected in advance. The safety risks can then be managed to an acceptable standard.

7.4.1 MONITORING METHODS

The type of instruments selected for a slope monitoring program depends on the issue to be monitored. A comprehensive monitoring system may include instruments capable of measuring rock mass displacement, ground water parameters and blast vibration levels.

When selecting monitoring instruments, incorporate some level of redundancy in the system to cross-check instrument performance and eliminate errors. Redundant or overlapping measurements will also provide a back-up in the case of instrument failure. Automated equipment is generally more accurate than manual equipment since some human factors are removed. Automated systems also provide added flexibility in the sampling rate and can therefore monitor more frequently than manual readings. Another distinct advantage of automated systems is their ability to trigger alarms if certain threshold limits are reached.



Instruments should be placed where they will be the most effective. Estimating the movement expected in a particular area should help ensure the limits of the instrument are not exceeded. There may also be environmental limitations (e.g. extreme heat or cold) that determine whether an instrument will work at a specific site. These factors need to be evaluated against the primary objectives of the monitoring program.

Typical surface and subsurface monitoring methods use techniques such as:

- > visual inspection
- > surface extensometers and crack monitoring
- > terrestrial geodetic surveys
- > GPS stations with prisms
- > radar
- > subsurface techniques
- > micro-seismic monitoring
- > monitoring of groundwater pressure.

7.4.2 INSTRUMENTATION DATA

A detailed draft of monitoring and reporting procedures should be prepared during the planning phase and finalised after the instruments have been installed. At that time, responsible workers will be familiar with operation of instruments and specific site considerations. These procedures should include:

- > a list of data collection
- > equipment specifications, including servicing requirements
- > processing and presentation procedures
- > interpretation procedures, including alarm levels.

It is extremely important that the procedures specify what actions are to be taken if any collected data indicates a safety issue.

COLLECTION OF INSTRUMENTATION DATA

A competent geotechnical engineer or instrumentation specialist selected by the site is responsible for collection of instrumentation data determined during the planning phase.

When collecting data, the following activities need to be undertaken by a person who understands or can interpret the data collected:

- > processing and presentation of instrument data
- > interpretation of instrumentation data
- > responding to data variations
- > reporting conclusions.

7.5 REMEDIAL MEASURES

The selection of remedial measures taken following slope movement depends on the nature of the instability and the operational impact. Each case should be evaluated individually with respect to safety, site plans and cost-benefit analyses.

Stabilisation and repair methods are used when ground movement has already occurred where artificial support methods are used to prevent instability.

Let the material fail: If the failure is in a noncritical area of the excavation, the easiest response may be to leave the material in place. Work can continue at a controlled rate if the velocity of the failure is low and predictable and the mechanism of the failure is well understood. However, if there is any question about the subsequent stability then the material should be removed.

To prevent small-scale failures from reaching the floor of the excavation, both the number and width of benches can be increased. Catch fences can also be installed to contain falling material.

Support the material: If allowing the instability to fail is not an option, artificially supporting the failure may be a solution. Some operations have successfully used reinforcement such as bolts, cables, mesh and shotcrete to support rock mass. The use of such supports can be very expensive, however if the overall angle of a batter can be steepened and clean-up costs are reduced the added expense of reinforcement may be justified.

A careful study of the geological structures should be performed to select the proper reinforcement (i.e. length of bolts or cables, thickness of shotcrete and so on). Bolts that are too short will do little to prevent slope stability problems from continuing. In some cases reinforcement has only served to tie several small failures together, creating a larger failure.

Another potential solution to stop or slow down ground movement is to build a buttress at the toe of the slope. The buttress offsets or counters the driving forces by increasing the resisting force. Short hauls of waste-rock often make this an attractive and economical alternative for stabilising slope failures.

Remove the hazard: If a slope continues to fail, and supporting the slope is not a feasible alternative, you should remove the hazard. Flattening the slope to a more favourable angle with respect to the geology will often solve the problem. When catchment systems are not available, appropriate scaling methods should be used regularly to remove hazards associated with small rockfalls.

Removing (or unweighting) the top portion of a slide may decrease the driving forces and stabilise the area. However, this option is generally unsuccessful and in some situations where high water pressure is used unloading decreased the stability of the remaining material.

Since water pressure creates slope stability problems, dewatering using horizontal or vertical wells can be a significant way of controlling slope behaviour and minimising hazards. Surface drainage and diversions should also be used to keep surface runoff away from tension cracks and open rock mass discontinuities near the slope face.

7.5.1 INSTALLATION OF ARTIFICIAL GROUND SUPPORT AND REINFORCEMENT

If artificial ground support and reinforcement are included in the slope design, it is essential they are installed correctly and the timing of their installation is an integral part of the design implementation. For more detailed information on ground support and reinforcement systems see section 3.6.

Although some of the work involved in the installation of artificial ground support and reinforcement can be carried out from a safe distance (i.e. shotcreting, drilling and so on), the installation of mesh and bolts, including the plating and tensioning of them, may expose workers to much greater rockfall hazards than usual.

Increased risks to safety during installation must be clearly recognised and managed. In addition, no worker should enter an area of the operation that has unsupported ground unless they are installing ground support or supervising the installation of the support.

Where any worker installing or supervising the installation of ground support will be exposed to a hazard associated with unsupported ground, temporary support should be provided to protect them.



Consider the following when installing artificial ground support and reinforcement:

Storage and handling:

- > Artificial ground support and reinforcement products should be stored and handled to minimise damage or deterioration.
- > Steel components designed to be encapsulated in resin or cement grout should be clean of oil, grease, fill, loose or flaking rust and any other materials that may damage the grout or not properly hold within the resin.

Grout and other additives:

- > Grout is mixed according to the manufacturer's or supplier's instructions including cement to water ratio, correct mixing time, speed and water quality.
- > Any additives (e.g. retarders, accelerators, fluidisers) to the grout mix should be added in the recommended amounts and at the specified time in the mixing and pumping process.
- > Where full grout encapsulation of steel elements is required, the method of grouting should show a grout return at the collar of the hole. Other methods that can demonstrate complete hole filling may also be appropriate. All grout mixing and pumping equipment should be cleaned and maintained regularly.

Procedures during installation:

Procedures for artificial ground support and reinforcement installation should include:

- > the method of work
- > the support materials and equipment to be used
- > the layout and dimensions of the artificial ground support and reinforcement system
- > any method of temporary support necessary to secure safety
- > the procedures for dealing with abnormal conditions
- > the method and equipment for withdrawal of support
- > manufacturer's instructions relevant to the safe use of support
- > information on other hazards such as known zones of weakness, or proximity to other workings or boreholes
- > the area to which the procedures apply and the date they became effective.

Correct tensioning procedures (when required) should be used for the various types of artificial ground support and reinforcement.

The purpose of tensioning cables should be determined to establish whether post-tensioning or pre-tensioning is required.

Also consider:

- > Orientation of the hole should be appropriate for the geometry and expected mode of failure.
- > Plates or straps against the rock surface should have adequate thickness to prevent nuts being pulled through the plate or strap when loaded against the rock surrounding the hole.
- > Shotcrete thickness should be tested regularly during placement to make sure the specified thickness has been applied. A means of permanently marking the shotcrete surface with a depth gauge probe may be appropriate.

Samples of the shotcrete mix should be collected at specified intervals under normal operating conditions. They should be tested in a suitably recognised concrete testing laboratory for compliance with the shotcrete design specifications. These should state the slump of the mix, the uniaxial compressive strength and a measure of the toughness of the product.

Procedures following installation:

- > Have monitoring arrangements to ensure the artificial ground support or reinforcement system continues to be effective including monitoring for corrosion.

7.6 HISTORIC UNDERGROUND WORKINGS

Sites may mine or extract materials that have previously been mined by underground methods. There are high-risk hazards that can arise where surface operations approach and then progressively mine or extract through underground workings.

These hazards include:

- > sudden and unexpected collapse of the ground or walls
- > the loss of people or equipment into unfilled or partially filled underground workings
- > loss of explosives from charged blast holes that have broken through into the underground workings
- > overcharging of blast holes where explosives have filled cavities connected to the blast hole
- > risk of ejecta (fly rock) from cavities close to the floor and adjacent blast holes, particularly when explosives have entered the cavity from the blast hole during charging and the loss is not detected
- > the release of gasses from the underground workings that can affect the health and safety of people
- > the potential for spontaneous combustion if the material is coal.

The above hazards are significantly increased when the underground workings were not backfilled at the time of mining.

As these hazards are not generally evident during normal operations you should take additional measures to better define their nature and extent.

7.6.1 HAZARD IDENTIFICATION OF UNDERGROUND WORKINGS

A thorough review of previous mine plans is essential before development. The validity of old underground mine plans should be thoroughly checked, particularly if they are abstracted or copied from originals. While this is important to assess the likelihood of abandoned underground workings around an open pit, its accuracy should not be relied on.

A review of underground workings should be part of the design and planning of the site to make sure, as far as practicable:

- > all known underground workings are marked clearly on all working plans and the plans rechecked
- > there is recognition that the rock mass surrounding the underground workings may be highly variable in strength and potentially unstable
- > a three-dimensional model of underground workings is developed and used in all design, planning and scheduling.



It is essential that all plans are updated following all phases of exploration to ensure the revised outlines of the actual extent and shape of underground workings are recorded.

Where it is unlikely underground workings could be of large dimensions and extended in length and depth, or where no previous plans are available, it may be necessary to confirm the location of the underground workings. Several detection methods are available that may be used to confirm the lateral extent and shape of underground workings including:

- > probe drilling
- > geophysical techniques (including seismic, resistivity, conductivity and gravity methods)
- > ground probing radar
- > laser-based electronic distance measurement (EDM) surveying methods
- > closed circuit television (CCTV) cameras lowered through probe holes
- > where practicable, actual physical inspection and survey.

Once the relevant hazards have been adequately defined, you must put in place controls to mine or extract safely over and through the underground workings.

7.6.2 RISK CONTROL

Consider the following control measures to eliminate or minimise the risk of unexpected floor or wall collapse:

- > placing fill materials into the underground workings
- > leaving a pillar of adequate dimension between the existing working bench and the underground workings by stowing or collapsing
- > restricting work to areas clear of the suspect location, with an adequate margin of safety
- > blasting waste rock into voids, followed by further back filling to stabilise the area.

If there is a risk of intersecting underground workings, a geotechnical assessment should be carried out to determine the minimum stable floor pillar or rib pillar dimensions.

All areas of a working bench likely to be underlain by underground workings should be clearly marked and access to the area controlled by a specific set of procedures.

These procedures should address a range of issues including:

- > minimising pedestrian movement
- > the workers responsible for monitoring and marking out the hazardous areas
- > probe drilling procedures
- > marking out the extent of the underground workings
- > drilling and blasting
- > plant and equipment movement
- > placement of fill materials in unfilled workings
- > rock stability monitoring
- > daylight and night operations
- > plant and equipment specifications
- > regular communication of information and discussion of issues of concern with all those involved
- > review of the procedures as the depth of the pit increases.

Allowance should be made for the uncertainty in the precise position of underground workings and any potentially unstable ground surrounding the underground workings. An extra margin of safety should be allowed in the separation of permissible works areas from suspect zones.

When extraction approaches operating or abandoned underground mines, the potential hazards may include:

- > flooding from or into the underground workings
- > instability of the slopes and surrounding surface areas
- > adverse effects on the underground mine ventilation system
- > spontaneous combustion
- > collapse of unfilled stope voids
- > deficiencies in co-ordination, communication and control of mining activities between the surface and underground mines.

Each of these hazards must be adequately investigated and controlled by appropriate means according to the identified risk.

7.7 **WORKING NEAR SLOPES**

Managing hazards from individual rocks falling from a slope (highwall or face) is achieved through a combination of four techniques. These are:

- > supporting or controlling the fall path of potentially loose rock
- > scaling the loose rock
- > providing rock catching berms or benches or both
- > limiting workers' exposure to areas where loose rock is on the slope.

Before allowing people to work near a slope, the slope should be thoroughly inspected for hazards including loose rock. When loose rock is identified it should be scaled off the slope or the area beneath the loose rock should be cordoned off.

Benching effectively reduces workers' exposure as does moving roadways and work areas farther out from the base. In addition, mobile plant should be worked perpendicular to the base of the slope as it provides the operator with a better view of the face.

When working near slopes the following safety precautions should be followed:

- > A bench is located in the slope above the work area. Space the bench so you can clean the face of the immediate wall (the section of wall from the floor up to the first bench) with mobile plant or equipment available at the site.
- > Don't position workers between the slope and any part of any mobile plant or equipment that would hinder their escape from falls or slides.
- > Safe access to the top of the slope is critical to allow for examinations of ground conditions.
- > Clear the top of the slope of loose, hazardous material before the shot material exposing the face is brought down. Use mobile plant (e.g. an excavator) that can reach the edge of the wall from safe staging and use the outward force of the bucket to remove loose material from the top edge of the wall.

- > A buffer that locates workers a safe distance out from the toe of the wall is essential. This may be achieved by placing the loading excavator on a rock platform with a rock trap (or trench) between the excavator and the face (see Figure 38).
- > Mobile plant should work perpendicular to the face or toe while in the impact zone.

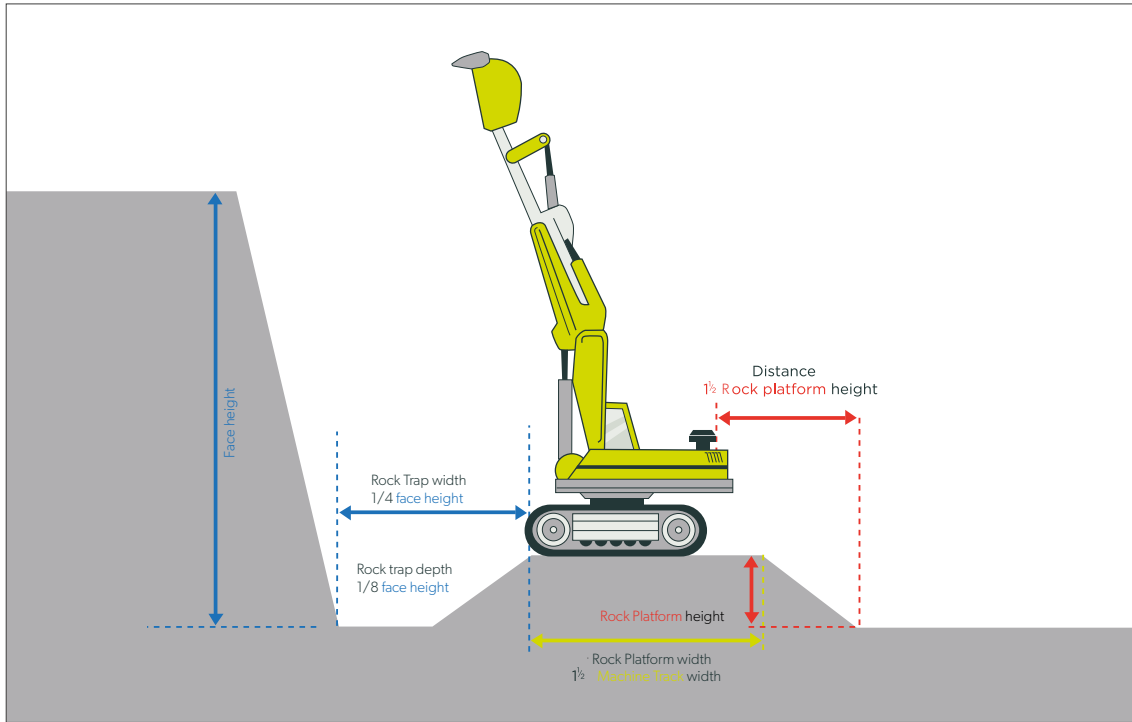

Figure 38. Rock trap design



08

PART **C**

Dumping (or tipping)

IN THIS SECTION:

- 8.1 Dumping methods**
- 8.2 Controlling end-tipping risks**
- 8.3 General risk controls**
- 8.4 Procedures for examining dump heads**
- 8.5 Dump maintenance and inspection**
- 8.6 Other considerations for stockpiles**
- 8.7 Reworking or reshaping dumps**

Instability or movement in dumps and stockpiles can cause serious harm. To minimise this risk, actively manage dumps and stockpile, and have robust procedures in place.

This section describes:

- > common risks from dumps, stockpiles dumps and tipping materials and ways to control them
- > procedures for inspecting tip heads and tip condition.

Incidents can occur for various reasons when dumping. These reasons are unsafe dump head conditions, unsafe dumping practices or a combination of the two.

Some unsafe dump point conditions include:

- > **No windrow or restraint, or an inadequate windrow or restraint.** This makes the edge location difficult to judge, offers inadequate restraint to keep a vehicle from going over the edge.
- > **A windrow that is too narrow at the base.** This allows the heavy loading of the truck to get so close to the edge of the dump that the edge material may not be strong enough to support the weight.
- > **An edge of a dump that has been weakened** because the dump has been loaded out at the toe and over steepened. Edge material may not be able to support the truck weight and its own weight. A portion of the windrow may have fallen away, reducing the windrow's capability to provide restraint.
- > **An edge of a dump that has been undercut.** Overhanging conditions can be created especially when the dump material is frozen, or has sat for an extended period.
- > **Cracks, settlement, or a slide near the edge of the dump.** The edge may be unstable and may not support the additional truck weight.
- > **A soft area near the edge of the dump** may cause tyres to sink in and the truck to tip over as it attempts to dump.
- > **A dump that runs downgrade to the windrow.** Gives drivers less control while backing and can soften the dump area from poor drainage.
- > **A dump that's placed on a soft or weak foundation.** As the dump gets larger, the slope may become unstable due to the foundation giving way underneath.
- > **Inadequate lighting for night operations,** or poor visibility during inclement weather. Makes driver judgements, and detection of unsafe conditions, more difficult.
- > **Inadequate clearance** between equipment and overhead power lines. Two particular concerns are that truck trays are raised at dump points, and as dumps get larger the clearance may become reduced.
- > **Congestion around the dump head** where dump trucks or other mobile machinery congregate and crowd the dump head due to operational delays or unplanned events.

8.1 DUMPING METHODS

There are three methods of dumping:

1. **Paddock dumping** where loads are dumped close to each other and, if another layer is to be built on top, the surface is levelled and prepared for the next lift using fit-for-purpose mobile plant.
2. **Dump short and push off** where loads are dumped and pushed off a dump edge.
3. **End-tipping** where loads are dumped down a free face and the load slides down requiring regular maintenance and rebuilding of windrows.

Paddock dumping or dumping short and pushing off are the preferred options for all dumps. This is because these methods generally eliminate the hazard of trucks reversing off an edge or the edge collapsing due to increased weight from trucks. Under carefully managed circumstances end-tipping can be done safely but involves significantly greater risks of slumping or slope failure.

8.2 CONTROLLING END-TIPPING RISKS

When heavy vehicles operate near the edge of a slope there is a risk the edge material will not support the vehicles. This is especially relevant on dumps or stockpiles where the material is normally in a relatively loose condition.

In a dump or stockpile the material is typically at its 'angle of repose'. The angle of repose is the angle at which the material rests when simply dumped in a pile. This angle will vary depending on the size and shape of the constituent particles, how the material is dumped and the amount of moisture in the material when it is dumped.

For a pile of material at its angle of repose, the edge of the pile is by definition marginally stable. When dumped or pushed over the edge, the material tends to slide until it comes to rest at an angle where it can just barely support its own weight. Therefore, it is hazardous to bring the heavy weight of a truck close to the edge of an angle of repose slope. When this occurs, the slope material must support not only its own weight but also the additional weight of the loaded truck.

If the additional weight of the truck causes the material's shear strength to be exceeded, the edge of the slope will give way under the weight of the truck. This is the reason there is an ongoing history of serious incidents at uncontrolled tip heads.

The edge of a pile can also become unstable if the foundation cannot support the weight of the material and begins to give way. Especially in a dump of overburden, the edge may become unstable because of a zone of weak material in the dump. Sliding may occur on a layer of the material.

Because the dump head must be capable of supporting the weight of the vehicles being used, normally a truck, and withstand the other dynamic forces imposed in stopping and dumping near the edge, engineering processes and checks that dumps are being maintained to meet design specifications and tolerances are essential. This is to make sure dump edges remain stable and capable of withstanding the weight of vehicles dumping over an edge.

End-tipping should therefore only be done where the following risk mitigation measures are in place and maintained:

- > A geotechnical assessment of every dump with a minimum Factor of Safety of 1.2 (refer section 4 for more information).
- > Dumps and tip heads (including windrows) should be designed (with drawings, see figure 39 for an example), formed from consolidated layers and terraced or stepped back to minimise fall risks.

- > The edge and windrows should be systematically maintained while end-tipping.
- > The windrow should be used as a visual guide only. The windrow should not be used to help stop the truck but only as a visual guide to judge where to stop.
- > There is adequate supervision of dumping operations to make sure unsafe conditions are being corrected and safe practices are being followed.
- > There are specified intervals for reviewing the end-tipping and auditing of the processes.
- > Unusual material (e.g. weaker or wetter) should always be treated differently than standard overburden. Unusual material should always be paddock dumped in an area where it will not compromise dump stability.
- > Do not exceed 20 m in vertical height for each lift without toe support or a buttress.

Track-dozers are preferred for maintaining dump heads because they distribute the weight of the mobile plant over a greater area than a rubber-tyred dozer, subsequently decreasing ground pressure.

When dumping short, a good rule of thumb is to dump one truck-length back from the edge. It is good practice to use suitable markers (e.g. cones, coloured poles/bollards) to indicate dump zones.

The benefit of using this method is that the truck drivers are not exposed to the potential hazards at the edge of the dump. They can complete the haul quicker since they don't need to be as precise in backing and positioning the truck when they are dumping.

To eliminate the hazard of trucks reversing into water, only backfill water-filled areas by the dump short and push off method.

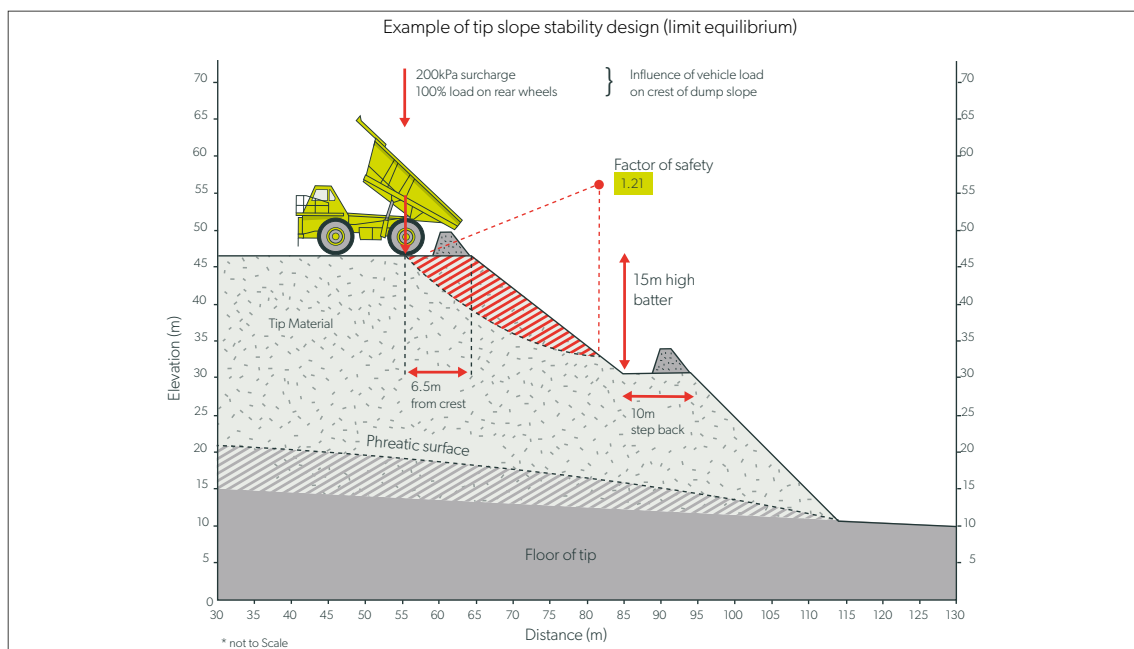

Figure 39. Example of tip slope stability design (limit equilibrium)

8.2.1 DUMP CONSTRUCTION PROCEDURE

All dumps should have a construction procedure to follow when dumping. This procedure should:

- > describe how the dump design from the geotechnical assessment will be implemented by the workers
- > specify the overall slope angle, maximum heights of batter slopes and minimum bench widths
- > consider the type of material being dumped and the dumping method
- > consider the size and type of vehicles being used
- > include windrow specifications (refer 8.2.3 for more information)
- > be easily understandable by the workers dumping.

Workers should be trained in the procedure and dumping should be monitored to ensure the procedure is being followed.

Using diagrams is a good way to communicate the procedure to workers. Figures 40 and 41 are examples of easily understood dump construction procedures that describe how the dump design from the geotechnical assessment will be implemented.

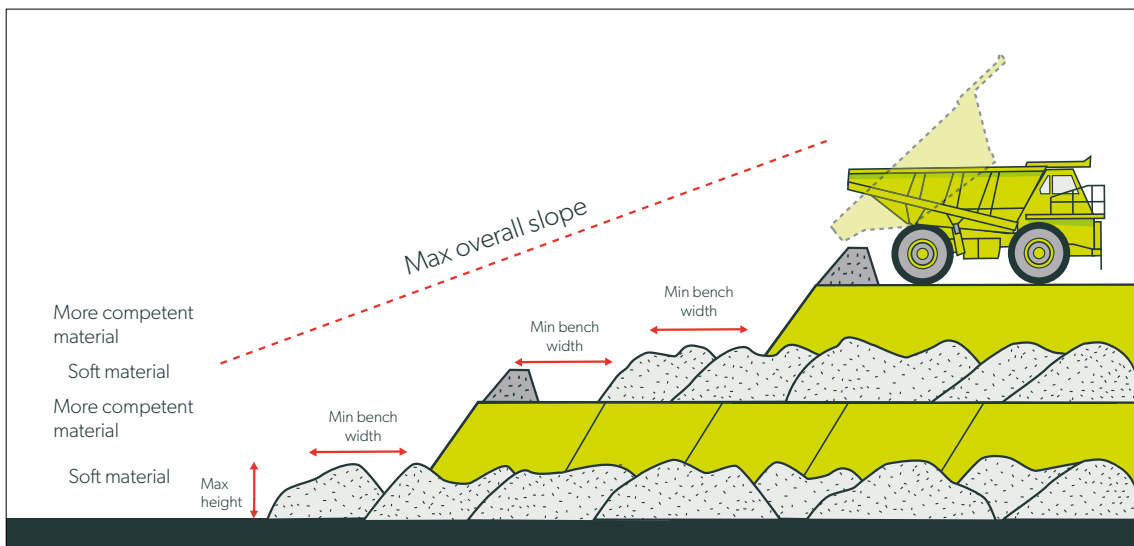

Figure 40. Example dump construction method for mixed material (mattressing)

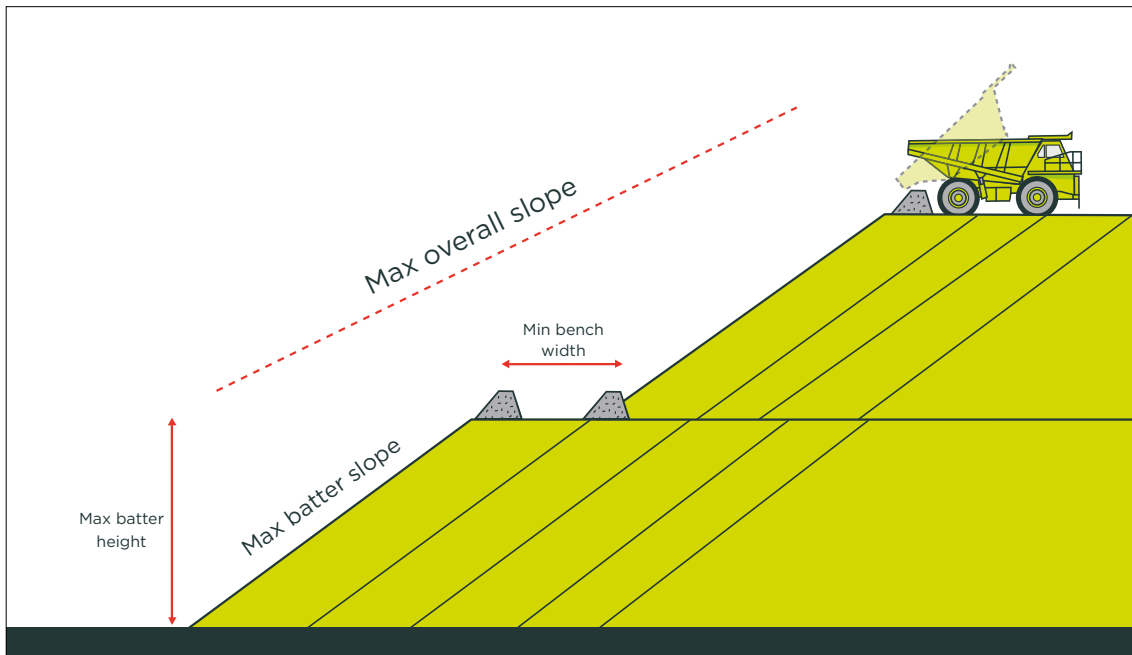

Figure 41. Example dump construction method for competent material

8.2.2 DUMPING METHODOLOGY

Loads should be dumped in phases according to the design to ensure stability and to allow the dump face to be built out uniformly. A phase is a series of dumps whereby progressive loads are dumped adjacent to the previous one (refer Figure 42).

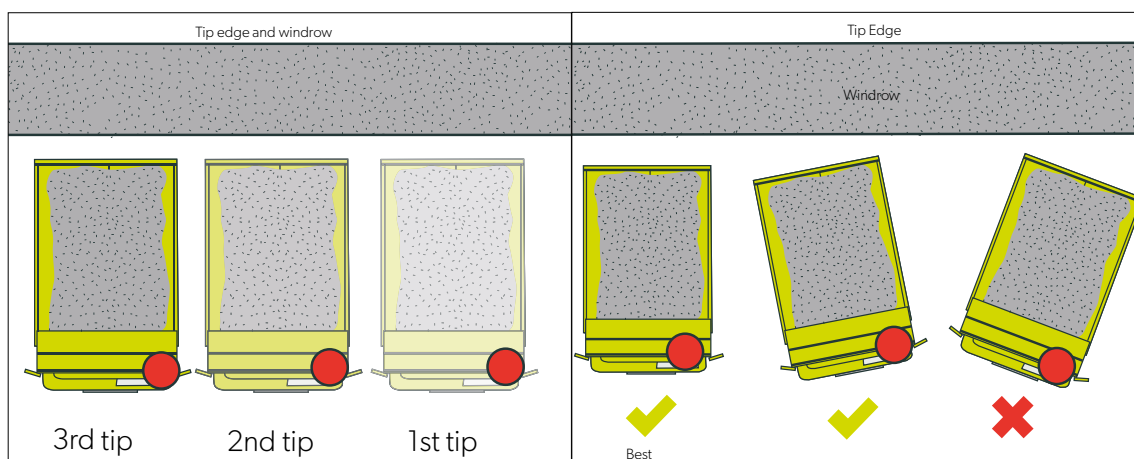

Figure 42. Dumping sequence

There should be communication between the mobile plant operators and the truck drivers to advise when the next phase can start.

When reversing close to the edge of a dump, drivers should reverse slowly and come to a gradual stop at the dump head. As a truck reverses up and the brakes are applied, dynamic forces are produced which push down and out on the dump. The more abruptly a vehicle stops, the higher these forces are. Additionally, as the truck body is raised the load shifts to the rear axle and the load is directly applied to the ground under the rear tyres as a point load momentarily until the load is dumped.

These forces can make a stable edge give way. Drivers should reverse perpendicular to the edge, or with the driver's side tyres leading just slightly (refer Figure 43). In many dump head incidents, the tyre tracks have revealed the truck was reversing at an angle, with the rear tyres opposite the driver leading. In these cases, the driver's side mirror would have indicated the driver still had a distance to back up, while the opposite side rear tyres were already making contact with the windrow or going over the edge.

8.2.3 CONSTRUCTION OF WINDROWS AT DUMP HEADS

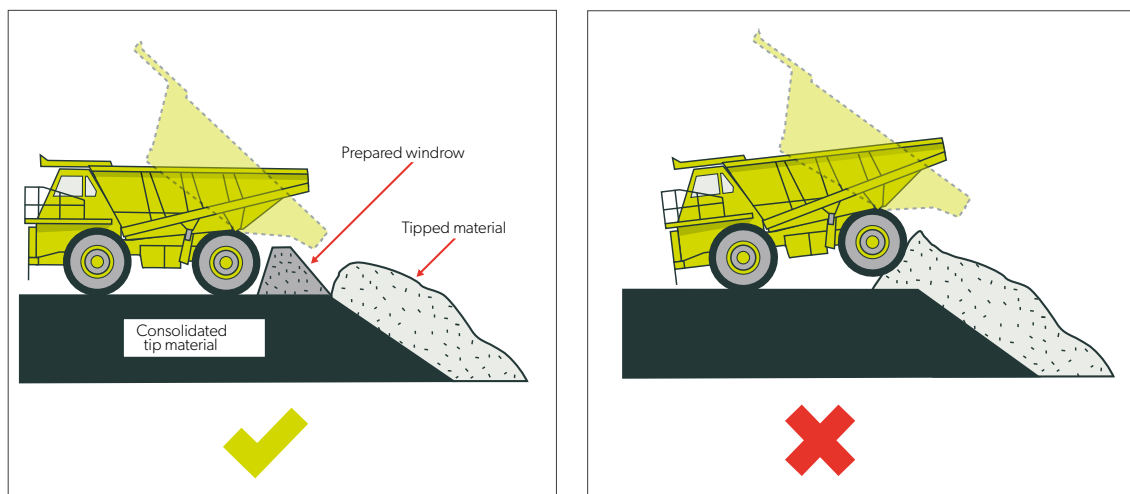

Figure 43. Approaching tip point windrow

A critical function of a windrow at a dump head is to keep the heavy load on the rear tyres of the truck from getting too close to the edge. In this respect the height of the windrow is important because the higher the windrow, the wider the base of the windrow. It is this wide base that is critical in keeping the load back from the edge.

Windrows should be considered a safety extra and should not be used as a brake or even an indicator that the edge has been reached.

They must be designed, constructed, installed and of sufficient height to offer definite restraint in the event a vehicle accidentally hits them. While traditional rules of thumb for windrow heights (i.e. half the height of the wheel) may be useful, they are often not supported by design calculations and could be inadequate as a safety barrier.

Design parameters for windrow construction should be followed and include:

- > using material to construct the windrows that is non-uniform in size, to allow interlocking of particles for greater cohesion and strength
- > sloping the outer face of the windrow to its natural angle of repose. The slope should be pushed up steeper on the inner face (but must maintain adequate width)
- > the width and distance must be enough to keep the heavy loading on the rear tyres of trucks from getting too close to the edge where the material could give way.

8.2.4 CONSTRUCTION OF STOP-BLOCKS (OR WHEEL BACK-STOPS) AT PERMANENT DUMP HEADS

When a truck (or loader) dumps off a permanent dump head (e.g. into a hopper), adequate stop-blocks should be in place. The stop-block should be designed, constructed, installed and of sufficient height to offer definite restraint. The stop-block should be adequate for the largest vehicles that will use the dump head. This should be up to 0.5 x wheel size depending on design and material used. Consideration should also be given to the clearance needed when the truck body is in its maximum raised position. Remove spills (including gradual build up) that accumulate in front of the stop-block as these will reduce the height of the block.

8.3 GENERAL RISK CONTROLS

8.3.1 OVER HEAD HAZARDS

Carry out dumping operations clear of overhead hazards such as power lines and pipework and continuously check for overhead hazards. If a dump or stockpile increases in size, vehicles may gradually begin working closer and closer to overhead hazards that were too far away to be a concern when the dump or stockpile was started.

Any overhead hazard should be signed and clearly identified with hazard warning devices such as pre-impact structures, flagging or lights.

8.3.2 VISIBILITY OF A DUMP SITE

Adequate lighting must be provided. The area should be illuminated well enough to allow signs of dump head instability, such as cracks, to be detected. If visibility is poor (e.g. due to bad weather conditions), dumping should be stopped or other controls implemented to maintain safety (e.g. trucks should dump back from the edge).

During adverse weather, a trigger point should be established that will determine when operations will need to be modified or stopped due to reduced operating parameters. This can include visibility, temperature (freezing), traction on pavements (rain) and wind.

8.3.3 VEHICLE MANOEUVRING

It will usually not be possible to completely avoid reversing of trucks where dumping is required. However, reduce the amount of reversing to as little as possible. For more information on reversing, see section 10.1.

Dump heads should be of sufficient size to permit manoeuvring by the largest equipment that is intended to be used.

8.3.4 DUMP-POINT SURFACES

The horizontal surface at the dump head should be kept level from side to side so trucks won't tip on their sides when the tray is raised (refer Figure 44).

The surface of the dump head should be kept sloped a small amount so, when reversing to the dump head, the trucks will be going up a slight grade (refer Figure 45). This gives the driver better control. It also provides a better opportunity to get the truck out if any ground shift occurs, and keeps the dump head better drained.

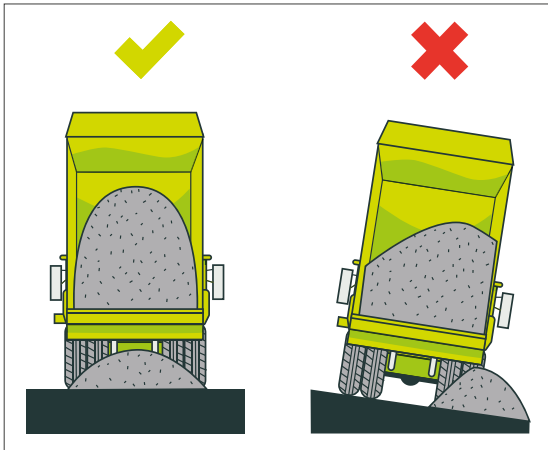

Figure 44. Vehicles should be parked on level ground (side to side) when dumping their load

8.3.5 COMMUNICATION

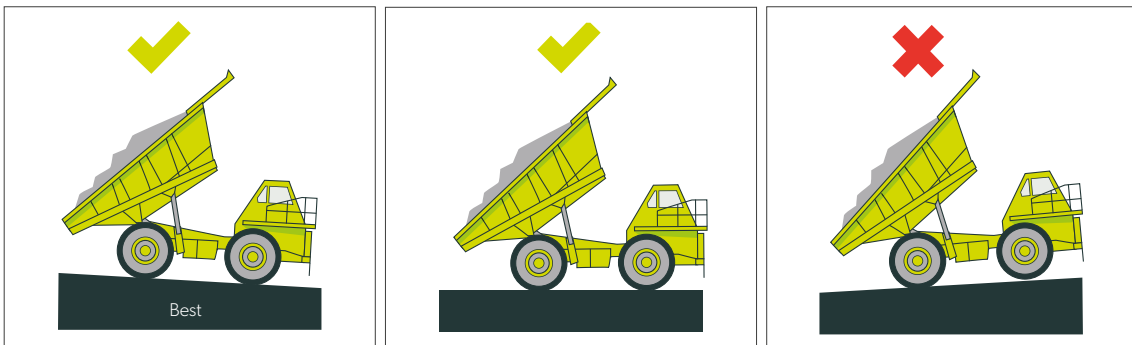

Figure 45. Dump on level ground with a slight uphill gradient

There should be a clear and effective system that allows communication between anyone entering the stockpile or dump area, such as two-way radio.

A protocol should be established to define who is coordinating the dump head. If a dozer is present at the dump head it is good practice to assign this to the dozer driver. If a dozer driver is not constantly present then other arrangements should be made where multiple trucks may be there at the same time.

This protocol needs to include other vehicles such as water and maintenance trucks.



8.3.6 USING SPOTTERS

A spotter is someone who guides a truck into the dumping position, either from a safe viewing platform protected from the elements or in a stationary vehicle.

A spotter should always spot the truck from the driver's side. Where spotters are used, radios should be provided.

Spotting platforms should be highly visible to all vehicles.

8.3.7 USING TECHNOLOGY

Make use of new technologies such as proximity sensors and vehicle mounted cameras that can improve both dump head safety and efficiency.

A rearward facing camera can assist a truck driver in backing up square to the dump head and in knowing how close to the windrow the vehicle is positioned. They should always be provided where end-tipping is undertaken.

8.3.8 TRAFFIC FLOW

Consider the types of vehicles entering the dump head when determining a direction of travel (e.g. driver cabs may be on the left or the right hand side). Approaching with the dump head to the driver's cab side gives the driver the best opportunity to check the condition of the dump head before dumping.

Drivers should stay back from the edge a minimum of one truck length on their approach and in making their turn.

8.3.9 TOE EXCLUSION ZONE (PROHIBITED ZONE)

A toe exclusion zone should be established at a safe distance from the toe of all working dump and stockpile slopes. Barricade fencing, windrows or traffic cones and warning signs should be erected where there is a risk of harm.

8.3.10 RESTRICTED ACCESS FOR LIGHT VEHICLES AND WORKERS ON FOOT

To make sure no additional traffic hazards are introduced there should be restricted access to operational areas of a dump for light vehicles and workers on foot. Signs should be erected indicating restricted access areas.

Where light vehicles are required to access the dump head you should establish dedicated light vehicle parking areas and have protocols in place to eliminate pedestrian and heavy vehicle interaction, including stopping operations until pedestrians have left the dump head.

8.3.11 SEGREGATION OF VEHICLES AT THE TIP HEAD

Demarcated routes, for use during night or day, should be provided. This should ideally separate access to and exit from the dumping areas. One-way routes are preferable. By restricting movement to defined routes, grading and watering requirements are reduced.

Vehicles in the dumping area should always remain in the view of the driver of a reversing vehicle (i.e. on the cab side). Vehicles should remain at least one truck width apart from other vehicles while dumping (refer to Figure 46). This leaves room in case a truck tips over on its side while attempting to dump. Truck drivers should never drive within the reversing path of another vehicle.

Do not reverse a vehicle blindly in a dumping area. Drivers should make full use of visibility aids and should not reverse until they are certain the path is clear and only if protection is in place adjacent to any edge of a hazard. Safe operating procedures should outline the protocols and rules when working at a dump head.

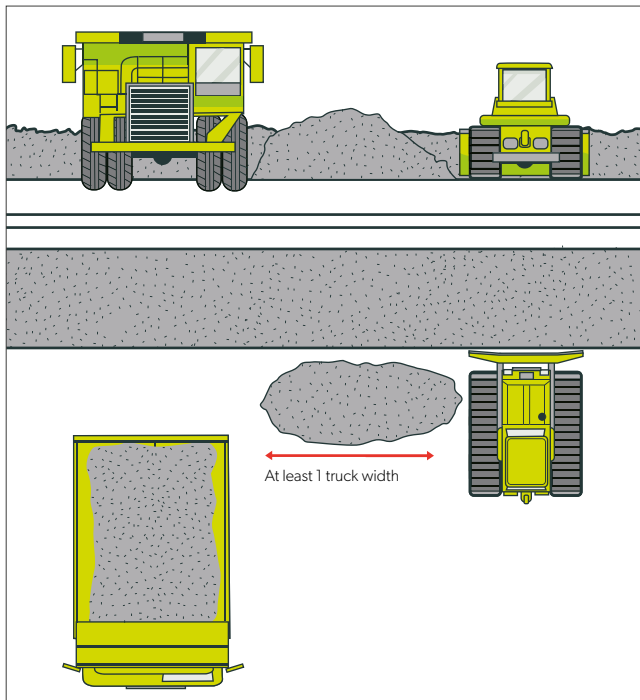

Figure 46. Vehicle separation at tip point

Light vehicles should go to the designated area if there is one. If not, they should stay a nominated distance away from the trucks dumping or queued to dump, similar to having a loading clearance zone. Trucks should queue in a location that ensures they will be safely separated from the dumping truck and in clear view of that truck's operator.

8.3.12 DUMPING THE LOAD

Drivers should be trained on how to safely handle sticking material (hang-ups) in truck bodies. Sticking material can make the truck tip over as the tray is raised or cause a more critical loading condition on the edge of the dump. If the tray gets to about two-thirds of the way up and material is still sticking, the driver should lower the tray and find another means of getting the material out (i.e. using an excavator). When material sticks in the tray, on no account should drivers try to jar it loose by jamming on the brakes as they reverse. The truck could tip over, the tray hoist could fall causing sudden extreme movement or, if this is done near the edge of a dump, the added force could cause the edge to collapse.

A safe system of work should be established for dumping loads. When the truck is positioned, the driver should apply the park brake before putting the transmission into neutral. When the hoist or tray is rising, the truck driver should use the mirrors to watch the material flowing from the tray to ensure there are no side spills or uneven flow (which may indicate a hang-up). Regularly check for cracking or slumping of the dump head.

8.3.13 RAISED TRAYS AND ALIGNMENT OF ARTICULATED VEHICLES

The vehicle should stay level if it is moved forward during dumping. Driving with the tray raised should be restricted to short distances and only where it is required to fully discharge a load. Raised tray alarms and built in speed controls can reduce the risk of vehicles being driven with the tray raised.

Always align the tractive unit and trailer of an articulated vehicle when dumping (refer Figure 47). Provide enough space for a vehicle to manoeuvre the trailer and cab so they are lined up.

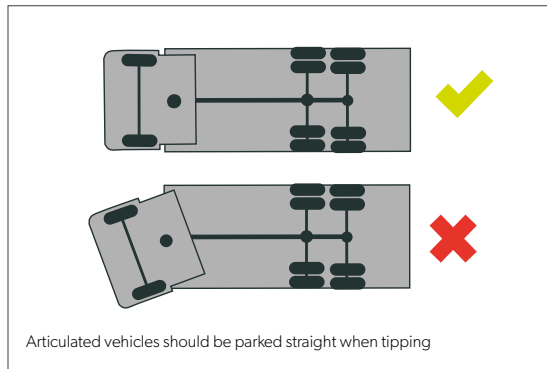

Figure 47. Articulated vehicles

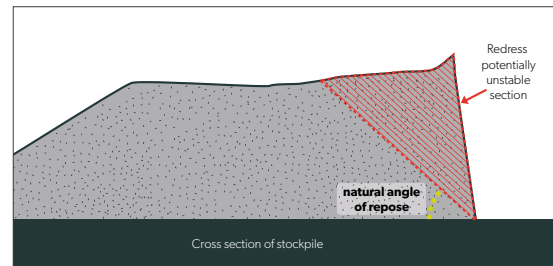

Figure 48. Cross section of stockpile

8.3.14 REMOVING MATERIAL FROM A STOCKPILE

The removal of material from the toe of a stockpile (either overburden or product) can have a significant effect on the stability of the edge. In the case of loose, free-flowing material, loading out at the toe may have little impact because the material tends to slide back to its angle of repose.

Once material has become tightly packed from vehicles on the stockpile, or from sitting for a period and settling in, the area where material is loaded out will generally stand at a steeper angle. Material standing at about 35 degrees when dumped over the edge can typically stand at 45 degrees once loaded out. In some cases, such as when material has been sitting for a long time, the material may stand even steeper or may even stand in an overhanging condition. With these steepened conditions, there is less slope material to support loadings on the stockpile and a sudden failure could occur.

Mobile plant operators should be trained to continuously trim the face so it does not overhang and collapse (refer Figure 48). Faces should be worked in a straight line so that wings do not develop and create a crescent face, which can be self-supporting in the short term.

Barriers should be installed to restrict access to the top of the dump above the area that is being loaded out. The purpose of the barriers is to isolate the potentially dangerous edge (which could be undercut) from drivers and to eliminate material being dumped on to the loader.

8.4 PROCEDURES FOR EXAMINING DUMP HEADS

It is critically important to examine a dump head for unsafe conditions on a regular basis. Dump head conditions can change due to new material being dumped, the effects of equipment near the dump head, weather conditions or even just the settling-in of material over time. In stockpiles, a big factor affecting the dump head condition is the loading-out of material from the toe of the pile.

At a minimum, dump heads should be visually inspected by a competent person before work commence at least once during each working shift and more often if necessary for safety. A written record should be made of each inspection.

Operators and supervisors should be trained in unsafe conditions and practices at dump heads. Operators and supervisors should routinely check the area for unsafe conditions, such as cracks, inadequate windrows, unstable material on the slope below the dump head or a loaded-out slope below the dump head.

Such conditions should be reported immediately and acted on including the suspension of operations as required.

For more detailed information on what to look for at a dump head see section 8.5.

At a minimum, before and during each work shift the dump surface, edges and faces should be inspected by a competent person for any evidence of instability. Clause 37 of the WHSMPS Regulation requires the mine operator to ensure arrangements are in place for the regular inspection of the working environment of the mine for the purposes of compliance with WHS laws.

A risk assessment of all areas of the mine must be undertaken and the following matters considered when establishing inspection arrangements:

- > the procedures for conducting inspections
- > when inspections are to be carried out
- > who is competent to conduct inspections
- > how many people are needed to conduct each inspection.

8.5 DUMP MAINTENANCE AND INSPECTION

Regular maintenance of dump surfaces should be undertaken, as well as the access and exit routes. This helps to make sure vehicle hazards due to spills, wheel ruts, potholes and water ponding are minimised. Windrows or backstops should be maintained in height and profile.

Control dust generation using water trucks or spray systems to reduce dust nuisance and poor visibility hazards. Dust control in dumping areas should be at least equal to that in loading areas.

When completing inspections look for indications of inherent failure mechanisms or defects due to poor operational practices.

These can include the following:

8.5.1 TENSION CRACKS OR SETTLEMENT

A tension crack or settled area near the edge of a dump or stockpile is a warning sign of an unstable, or marginally stable, slope. Cracking is an indicator that movement has already taken place. If movement has occurred, then the slope material is unable to support its own weight and should not be relied on to support additional weight, such as a truck.



If there is a tension crack in the dump area, vehicles should not travel over or near the crack. The additional weight of the vehicles may trigger the slope to fail. Loads should be dumped a minimum of one truck-length away from a crack or in an alternative area.

Cracked areas should be clearly marked and isolated so the area is not used or the condition should be immediately corrected by flattening that area of the dump. This can be done by dumping material at the bottom as a buttress and carefully pushing material down from the top using a track-dozer.

Tension cracks will tend to run parallel to the edge of the slope. In some materials, other types of surface cracking may occur as a result of the material drying out. Drying cracks tend to be randomly oriented.

It may be necessary to seek specialist geotechnical advice to fully assess risks and identify effective control measures.

8.5.2 MOVEMENT OF SLOPE MATERIAL

A crack or an escarpment (a steepened area where the material has slid) on the slope is an indication of instability. Bulging of the slope material is not always as apparent as cracks but it is another sign that the slope material is moving.

Bulging can be detected by looking along the slope of the dump, especially the area near the toe, and paying attention to any material that is not at the normal angle of repose. Bulging of the ground next to the dump is an indication the foundation underneath the dump is too weak to support the weight of the dump. A failure through the foundation could cause a portion of the dump to slide.

Where any signs or movement of bulging material is recognised, dumping operations should be stopped immediately. Dumping operations may resume after a risk assessment and consequent hazard controls (including reforming the dump) by a competent person have been actioned and completed.

8.5.3 SOFT AREAS

Ruts and accumulations of water may indicate soft areas. The hazard in this situation is that as a truck starts to dump the tyres may sink into the soft area. In the worst case, this could result in the truck tipping over, especially if combined with material hanging up in the tray.

Soft areas should either be clearly marked so the area is not used or the condition should be immediately corrected by re-grading and sloping the area to promote better drainage.

Drivers should stop dumping and move to a firmer area if they feel the tyres sinking and immediately report such occurrences to their supervisor.

8.5.4 INADEQUATE WINDROWS

Inspections should include checking windrows are adequate to prevent vehicles getting too close to the edge. Windrows must be designed, constructed, installed and of sufficient height to offer definite restraint in the event a vehicle accidentally hits them.

It is important vehicles do not back forcibly into a windrow. As the tyres sink into the windrow, the heavy loading on the rear tyres gets closer to the edge, which can cause the edge to give way. Inspections should include checking for tyre marks on the windrow material. If you notice tyre marks, the potential hazard of this practice should be discussed with drivers immediately and appropriate action taken. For more information on construction of windrows, refer section 8.2.2.

8.5.5 UNDERMINED SLOPES

When material is loaded out from the toe of a slope it makes the slope less stable and more prone to sliding. In this weakened condition, the material at the edge of the slope may not be able to support its own weight and the additional weight of a truck. An undermined slope is especially hazardous at a dump head because the additional weight of the truck, if positioned too close to the edge, can cause the edge to suddenly give way.

Because of this hazard, even without cracks or other signs of instability, dumping at or near the edge where the stockpile has been loaded-out and undermined should be strictly prohibited. If your examination identifies an undermined area, it should be cordoned off and rectified.

See 8.4 for more information on inspections.

8.6 OTHER CONSIDERATIONS FOR STOCKPILES

Walls or other supports provided to contain stockpiles should be designed by a competent engineer to ensure their stability. If stockpiles grow to an extent that was not anticipated, they should be subject to a design review to ensure safety. In windy conditions, spray water on the stockpiles to minimise the dust hazard (refer section 11.10).

8.6.1 ENGULFMENT

Engulfment can occur where loaders (or other mobile equipment) are removing material from a stockpile that is substantially higher than the loading equipment. Hazard controls (i.e. benching, height restrictions and continuously collapsing the face so it does not overhang) and emergency procedures (in the case of an engulfment) must be established.

Where using draw down points, (e.g. reclaims) there is a risk mobile plant will fall or inadvertently drive into a draw down hole. Major contributing factors include:

- > the suitability of mobile plant for the stockpile design and operating environment (e.g. mobile plant operating alongside relatively steep stockpiles with heights above the safe limits of mobile plant)
- > the operator not being aware of the location of draw down points and either driving into the hole or sliding into the hole
- > the operator driving over the top of a bridged hole that suddenly collapses
- > insufficient surface structures or other navigational aids that could be used by the operator to identify the location of draw down points.

Where there is a risk of engulfment, mobile plant should be designed to protect the operator and provide for prompt recovery of the operator. Consideration must be given to the rescue of people in the event of an emergency. Recovery systems and methods should be developed and tested. The controls outlined in Table 8 could be used.

CONTROLS	COMMENT
The stockpile mobile plant should be designed to withstand engulfment forces of at least 40psi (280kpa)	Assumes a safety factor of 2:1 and is based on USA stockpile dozer incidents and investigations
Devices to assist the mobile plant operator in determining whether draw points are operating	Devices include: <ul style="list-style-type: none"> > Flags > Lights
Pedestrians should be prohibited from the hazardous area at all times	For example, draw down points
Provide communication devices so mobile plant operators can communicate with the control room in the event of an emergency	Devices include: <ul style="list-style-type: none"> > Radio telephones (RTs) > Cell phones (where reception allows)
Safety equipment to: <ul style="list-style-type: none"> > Ensure the operator is in a safe atmospheric environment if the mobile plant cab is engulfed; and > Facilitate rescue 	Devices include: <ul style="list-style-type: none"> > Breathing apparatus > Rescue harness > Emergency lighting > Mats or portable bridges (to bridge the gap between stable ground and the engulfed mobile plant)
Position indicating devices to assist mobile plant operators in determining the location of draw down points in high risk zones should be used. Audible or visual alarms should be provided to alert the mobile plant operator	Devices include: <ul style="list-style-type: none"> > GPS > Cameras over draw down points > Proximity detection > Fixed structures to provide a reference point

Table 8. Engulfment hazard controls at draw down points

8.7 REWORKING AND RESHAPING DUMPS

Dumps may be reworked or reshaped for landscaping or for operational requirements (for example, forming roads over dumped material). A geotechnical specialist should be consulted when planning rehabilitation to ensure the stability of the dump. For more information on rehabilitating dumps, see section 4.6.



09

PART **C**

Mining in or adjacent to water bodies

IN THIS SECTION:

- 9.1 Planning and design
- 9.2 Excavation rules
- 9.3 Extracting beneath water
- 9.4 Floating plant and boats

This section describes how to:

- > excavate material safely beneath water
- > safely access floating plant.

9.1 PLANNING AND DESIGN

Before any excavation, a competent person should undertake and document an appraisal risk assessment of the ground conditions (both above and beneath the waterline) to determine all factors likely to affect the stability of the ground and the limitations that should be imposed on the excavation design.

The assessment should be reviewed and revised where necessary when a material change occurs in the ground conditions, excavation methods or equipment used. Effective ground control relies on geotechnical information obtained at different stages of the life of the site – during planning and design, at the implementation of the design and through daily operations.

Following appraisal of ground conditions, a design should be prepared setting out the measures to control ground instability. Where an existing design has already been proven, and the ground conditions at both sites are not significantly different, this design may be used as the basis for the design of a new excavation.

There is usually a relative lack of data available when the design is first developed. It is essential that information obtained during operations is consolidated with information in the geotechnical model and continually used to assess the suitability of the design in relation to ground stability.

If the mine is using a dredge, consider making an assessment if it falls into the category of a principal hazard (i.e. use a dredge. When multiple people could be on the dredge, there is a reasonable risk of multiple deaths in a single incident or a series of recurring incidents). If it is determined to be a principal hazard then a PHMP will be needed. It may be more suitable to manage the use of the dredge via a PHMP to have all the risk controls managed in one place.

9.2 EXCAVATION RULES

Excavation rules should be drawn up setting out:

- > the manner in which excavation activities should be carried out, specifying the type and reach of excavators or other equipment
- > the physical dimensions of the excavation including slope, depth, height of free faces, width of benches and position of catch-berms
- > the way in which material should be removed from the excavation
- > restricted access to the edge of the waterline
- > the nature and frequency of supervision
- > response to defects.

9.3 EXTRACTING BENEATH WATER

Excavations should be kept stable even if they cannot be seen. When extracting beneath water, slopes will be saturated.

Draglines, clam shells, cutter-suction dredges and long reach hydraulic excavators may over-steep the slope and cause failure. These slopes should be assessed and may need to be treated as a significant hazard. Working methods should be based on the geotechnical assessment of the material being excavated allowing for any variation of submerged materials.

The working bench should be kept flat and clear of equipment or material to enable a rapid exit in the event of instability of the face. The front edge of the bench should remain visible to the operator always. Tracks of surface equipment should face the excavation, or be no more than a 45° angle, with track motors facing away from the face (see Figure 49, Figure 50 and Figure 51).

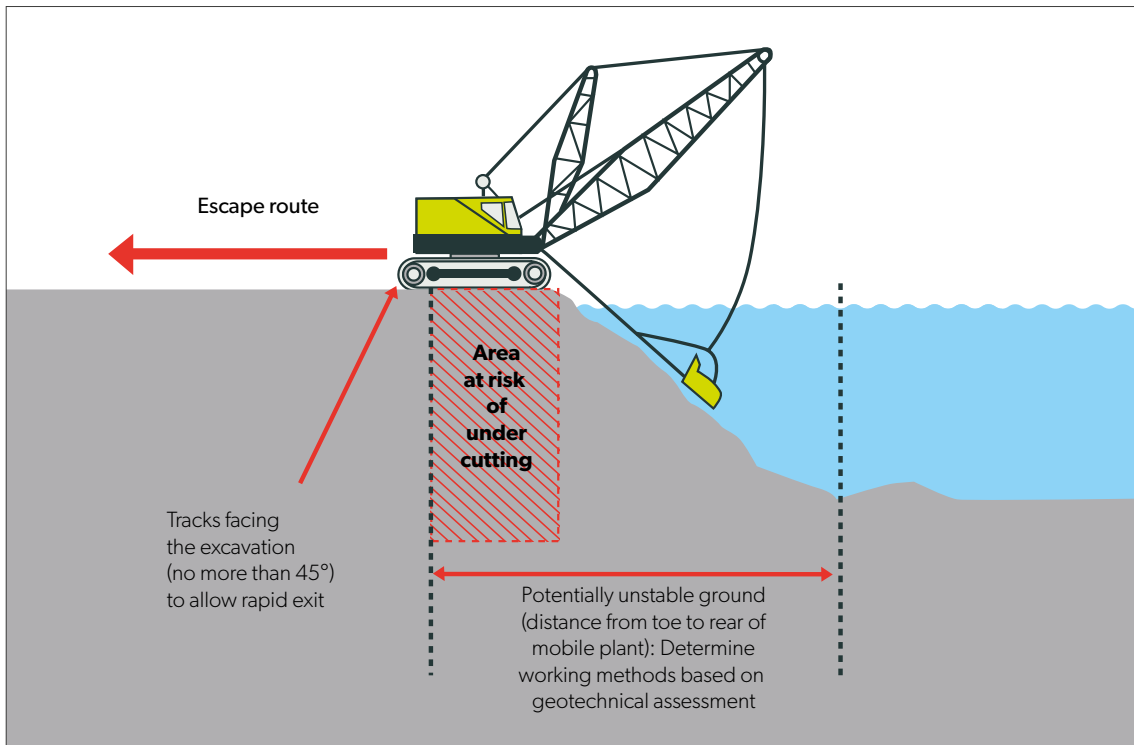

Figure 49. Dragline working beneath water

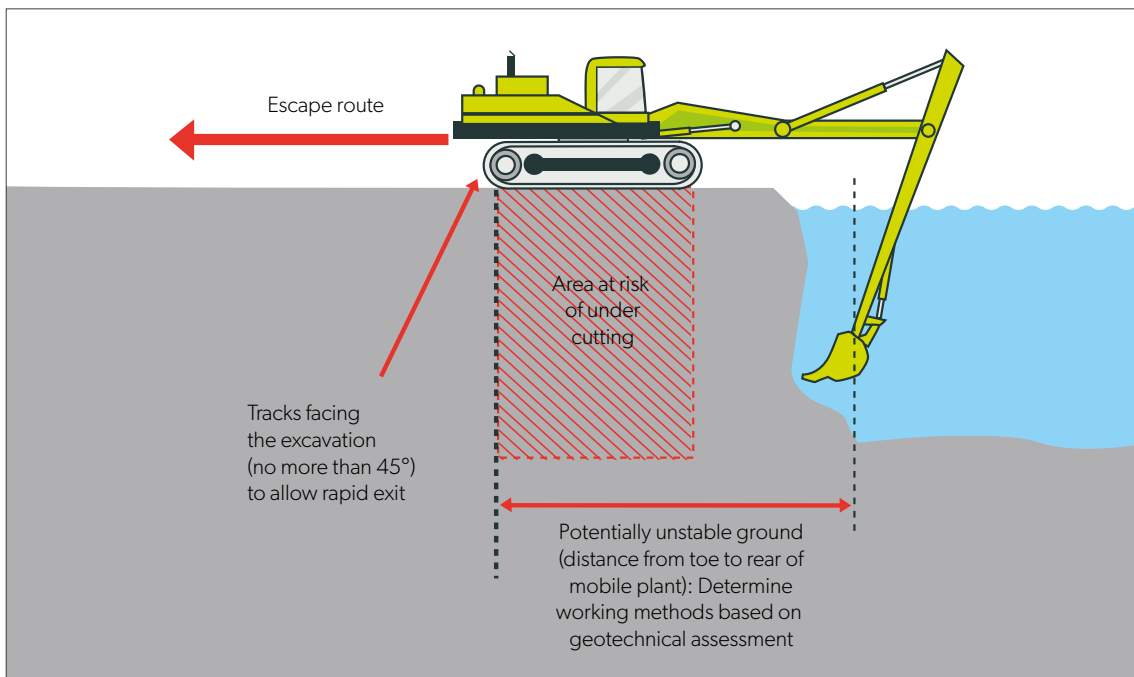

Figure 50. Long reach excavator working beneath water

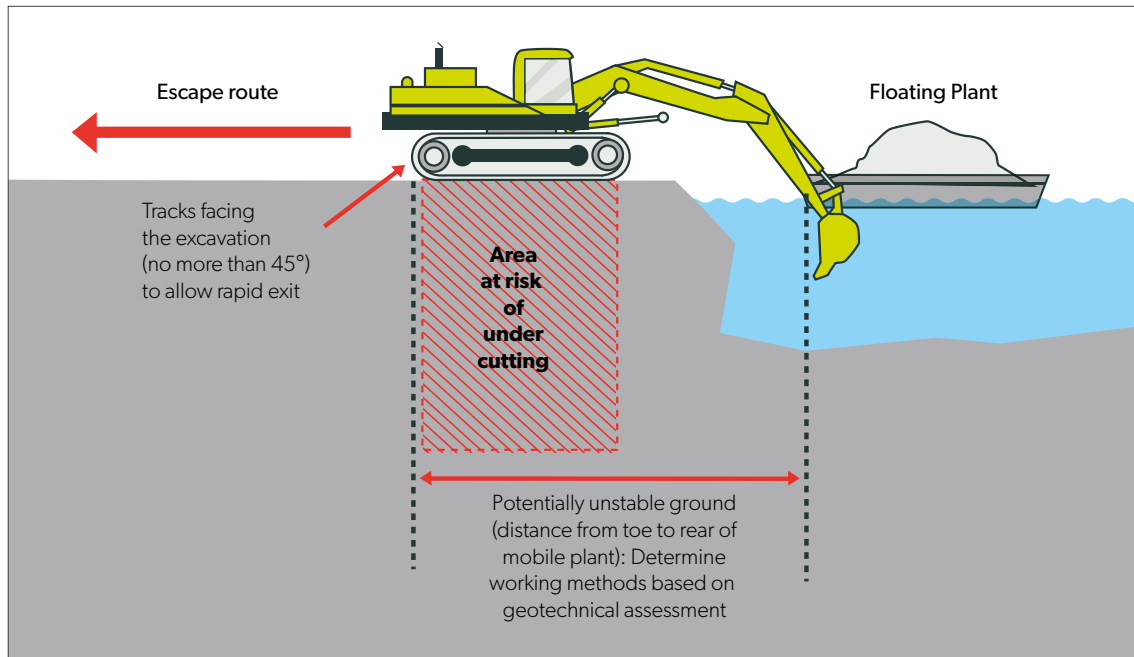

Figure 51. Excavator working beneath water, loading floating plant

Edge protection, barriers, warning signs and other suitable controls should be placed around any water filled excavation to keep people away from any hazardous zones. Edge protection, barriers or signs should be moved as the excavation progresses and the hazardous area changes. Rescue facilities must be provided (refer section 17).

If there is any doubt about the safety of excavations, operations must be stopped and remedial controls undertaken.

Where loading floating plant, there should be clear signals or communication between the excavator operator and the floating plant operator so feeding can stop if required. Where trommel screens are used, a visual or audible warning device should be used to alert the excavator operator if the trommel has stalled. Such an occurrence can cause the screen to become overloaded and could compromise the stability of the floating plant if loading continues.

Emergency procedures must be in place that may include equipping mobile plant with features or tools for use in an emergency (e.g. push-out windows or window breaking tools).

9.4 FLOATING PLANT AND BOATS

Floating plant or boats (including those used on settling ponds) may be governed by the requirements set out in the *Marine Safety Act 1998* and Regulation. Nothing in this section precludes operators from complying with the requirements of the Maritime Safety Act where it applies.

The Marine Safety Act incorporates the *Marine Safety (Domestic Commercial Vessel) National Law Act 2012* of the Commonwealth which provides a national system for domestic commercial vessels. A **domestic commercial vessel** is a vessel that is used for a commercial, governmental or research activity.

The Australian Maritime Safety Authority is the National Marine Safety Regulator.

The scheme does not apply to floating structure permanently connected to shore such as gangways, pontoons or floating jetties.

Vessels over 7.5 metres used for mining will typically be subject to, but not limited to, the following obligations:

- > certificate of survey
- > certificate of operation
- > safety management system
- > relevant certificates of competency
- > reporting of incidents
- > maintenance logs
- > crew training
- > safety drills
- > first aid
- > unique identifier.

The certificate of operation sets out the areas and types of activities that may be undertaken and it may include conditions to comply with. For example, where the vessel is being fitted with a lifting device such as an excavation bucket it may require a stability book to be used. A stability book serves the functions of a stability compliance report and the operator's stability manual – setting out operational limits and other requirements.

The national scheme is supported by the national standard for domestic commercial vessels. The national standard is made up of multiple parts dealing with such matters as:

- > design and construction
- > engineering
- > stability
- > equipment.

Floating plant is to be designed, manufactured and maintained to the required standard, thus ensuring that the floating plant will:

- > not become unstable due to shifting loads or being overloaded
- > remain stable while being towed
- > remain water worthy in operating conditions.

9.4.1 SAFE MEANS OF ACCESS AND EGRESS

Safe means of access (e.g. gangway) should be provided to vessels, floating processing platforms, draw-off points or submersible pumps where people must access them for work purposes (refer Figure 52).

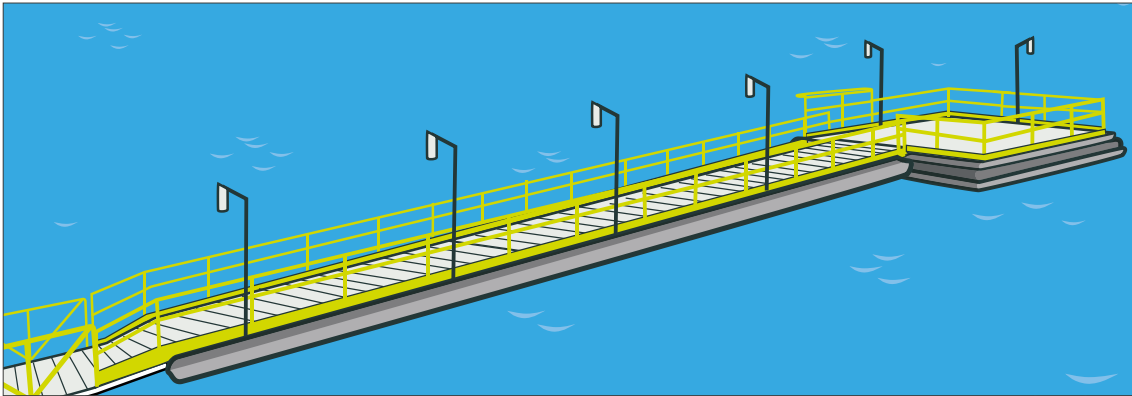

Figure 52. Example of gangway

Where using jetties, gangways, platforms, bridges or walkways, they must be fitted with suitable handrails, guardrails or other means to stop people falling in the water (refer to Figure 53).

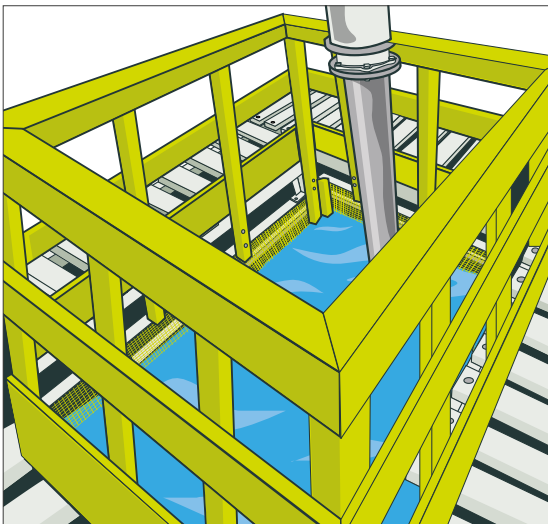

Figure 53. Example of guardrails around a water pick-up station

Cables and pipes should be separated or stored away from walkways to avoid tripping (e.g. in cable trays) and surfaces of walkways should be slip resistant.

Where traversing of jetties, gangways, platforms, bridges, walkways, stairs or ladders is required in the hours of darkness, sufficient lighting must be provided.

Where ponds and floating processing plants are being used in alluvial mining, precautions should be taken at the edge of the excavation (refer to section 7.5). While emphasis should be given to the stability of large excavators and unstable ground conditions, this should also include pedestrians accessing floating platforms from the excavation edge.

Clause 220 of the WHS Regulation prescribes how and in what a person may be lifted if the plant is not specifically designed to lift or suspend a person. Excavator buckets cannot be used to transfer people. To transfer people over any distance to a floating processing platform they must:

- > be lifted or suspended in a work box that is securely attached to the plant
- > remain substantially within the work box while they are being lifted or suspended
- > use a safety harness if there is a risk of a person falling from a height
- > be provided with a means to safely exit from the plant in the event of a failure in its normal operation.

Additional precautions that should be undertaken when an excavator is used include:

- > pedestrians enter the workbox from a position well clear of the excavation edge
- > no tracking of the excavator takes place during the transfer
- > no articulation of the arm or bucket takes place during the transfer
- > the work box is fitted with grab rails positioned clear of any hinge points or pinch points
- > the person is wearing a self-inflating life preserver
- > a clear line of sight is maintained between the passenger and the excavator driver
- > the excavator boom hydraulics are fitted with hose burst protection valves.

Do not have people on board floating plant while it is fed by an excavator.

Consider providing remotely operated rope winch systems and power wash systems during the design stage (safety in design). This eliminates hazards associated with workers making frequent visits to floating processing platforms.



Figure 54. Digger and floating screen

For more detailed information on construction and installation of platforms, walkways, stairways and ladders refer to AS 1657 (fixed plant), AS 3868 (mobile plant) and *The Building Code of Australia* (where applicable).



9.4.2 DESIGN AND MODIFICATIONS OF VESSELS

Do not submerge dredge or floating plant decks under any circumstances. If the freeboard of a dredge or floating plant appears to be insufficient, a competent person should be engaged to evaluate and rectify the buoyancy. This is particularly important when sludge builds up on the cutter head and when the cutter is driven into the bottom of the pond or into a working face during mining operations.

Equipment installed on the dredge or floating plant should be secure so that it won't shift and destabilise the dredge or floating plant.

Where trommel screens are used, an automatic tripping device or warning should be installed to stop the trommel screen if the tailings discharge belt stalls. Such an occurrence can cause the screen to get overloaded and affect the stability of the plant. Even where the trommel is monitored by a worker, automatic tripping devices should be installed because reliance on a person cannot be guaranteed every time.

Modifications can cause vessels to capsize because of additional weight or the effects non-engineered modifications have on the balance of the vessel. Establish change control procedures to ensure modifications to the original design do not exceed the design capacity set by the manufacturer.

Procedures should also consider examination and maintenance of safety controls provided by the manufacturer to make sure modifications to the original design do not reduce the in-process safety margin for loadings. For example, ensure dredge overload and full hopper alarm switches are functioning within the specifications of the manufacturer to maintain freeboard levels.

For more detailed information on barge stability see *National Standard for Commercial Vessels Part C Design and construction – Section C6 Stability - Subsection 6A Intact stability requirements*.

9.4.3 REPAIRS AND MAINTENANCE OF VESSELS

To ensure the integrity of vessels, operators should establish maintenance and repair programs. These may include:

- > regularly checking decks and hulls for cracks, corrosion and holes
- > sealing all covers over hatches in the deck with continuous excess marine sealant to ensure water tightness
- > regularly checking all hull compartment bulkheads are watertight. These compartments isolate water flow if water ingress occurs in any individual compartment
- > providing a sounding tube for each hull compartment that extends to near the bottom of the compartment so the compartments can be sounded daily for water ingress
- > procedures to make sure repairs are undertaken in pontoon cells when leaks develop
- > regularly checking ropes and rigging for signs of wear.

Dredges should also have an adequate capacity pump with a non-collapsible suction pipe long enough to reach the bottom of any hull compartment. When water ingress is detected, the water can be quickly and efficiently removed from the hull before buoyancy of the dredge is seriously affected.

The use of polyurethane or polystyrene in hull compartments does not ensure buoyancy of dredges. It is recommended these materials are not used because the materials deteriorate over time, becoming porous and water absorptive, and they do not allow for regular inspection of the hull compartment surfaces.

Hull compartments are likely to be confined spaces. Refer to the *Confined spaces code of practice* and AS 2865 for more information on confined space entry.

For more information on repairs and maintenance see section 16.

9.4.4 BOATS AND TENDERS

Boats, like any other equipment, should be of adequate size and power to properly perform the anticipated task. Weight capacity includes people, motor, equipment and any other haul load. If you are using a boat to retrieve an item, then the weight of the item should be taken into consideration when assessing if the boat is suitable for the retrieval task.

Boats must be operated by workers who are competent to do so or who are supervised by a competent person.

All staff working on any domestic commercial vessel in Australia must have a certificate of competency.

For more detailed information on the different certificates of competency and eligibility for them contact Australian Maritime Safety Authority or visit their website at www.amsa.gov.au.

9.4.5 PERSONAL FLOTATION DEVICES (PFDs)

Establish and enforce policies for wearing personal flotation devices (PFDs). Like seat belts in vehicles, PFDs are effective only when they are worn.

Provide sufficient quality PFDs that are appropriate for each worker's weight. Inspect and maintain the PFDs in serviceable condition and replace them if they become worn or damaged. It is recommended that spare PFDs be maintained on site for replacement of damaged units and for visitors.

Generally, Type 401 open waters lifejackets are the most appropriate lifejackets for a working environment. Type 401 lifejackets are designed to keep an unconscious person face up in the water. PFDs may include life buoys and life lines (ropes) stationed at suitable locations.

Life jackets should meet the Australian Standard for Personal Flotation Devices AS 4758, International Standard ISO 12402 or another equivalent standard.

Consider the PPE and equipment a worker will have on their person when considering PFDs. Lifejackets are to keep a worker's face out of the water, in case they are rendered unconscious.

Subject to the operational conditions and remoteness of a worker or workers (including emergency response time), consideration should be given to utilising lifejackets/PFD's with integrated safety systems that include an automated man overboard alert system should the unit become immersed.

Written procedures on the use and inspection of such equipment should be developed, considering the manufacturer's recommendations and training provided to all relevant personnel.

9.4.6 ROPES, PULLEYS, WINCHES AND RIGGING

All floating plant will require mooring. This is usually accomplished with winches and ropes.

On smaller plants with manual winches and rope, the common hazard is tripping. Larger plant may have substantial winches and large diameter wire ropes. These present additional hazards from gear failure (ropes or pulleys breaking) and whiplash as strain is exerted on rigging. One of the risk controls is to establish exclusion zones.

Ropes, pulleys and other rigging should be covered or protected. Workers should stand well clear of any hazardous zones when the ropes are taking strain.

Anchoring should be firmly positioned and not prone to undermining.

Galvanised ropes are advisable to prevent the unseen internal corrosion that can occur in steel wire ropes operating constantly in and around water. Regardless of the rope used, all associated equipment such as pulleys, rope clamps and sheaves should be specified based on the rope diameter and safe working load. A routine rope condition inspection procedure should be used, with an appropriate system of record management.

9.4.7 EMERGENCY EXITS

Cabins should have an emergency exit in the event of sinking or capsize, such as a push-out window or a trap-door. The emergency exit should be large enough to allow a person to pass through wearing their PFD.

9.4.8 FIRE SYSTEMS

Dredges and vessels with enclosed engine rooms should have a means of detection and alert in the event of excess heat, smoke and/or fire. There are various integrated systems that are commercially available and should be powered by battery and not from a generator or mains power.

All fire detection systems and fire-fighting equipment must be routinely tested and inspected with records maintained.

Workers should also be trained in what to do in the event of a fire on board the dredge or vessel.

10

PART C

Water or tailings storage

IN THIS SECTION:

- 10.1 Inspections and tell-tale signs of distress**
- 10.2 Technical operational review**
- 10.3 Cleaning out ponds**

Instability or failure of ponds and tailing dams can cause harm. Design, construct, operate and maintain ponds and tailing dams appropriately to prevent this harm.

This section describes how to:

- > inspect ponds and dams, and identify potential causes of failure
- > review ponds and dams periodically
- > maintain ponds and dams.

Safe systems of work should identify and control any risks to workers and anyone else who may be affected by activities associated with ponds and dams (including adjacent landowners). This includes workers who need access to potentially hazardous areas for purposes such as carrying out inspections and cleaning out ponds or dams.

Where a tip or pond has been identified as a principal hazard, mine operators should make sure a competent person examines ponds or dams where workers are, or will be, before the start of each working shift and at suitable times during the shift. At least weekly, every accessible area of the tip or pond, including areas with barriers, should be inspected by a competent person.

For more detailed information on planning and design criteria, geotechnical assessments and construction of ponds and dams see section 4.

10.1 INSPECTIONS AND TELL-TALE SIGNS OF DISTRESS

Once a dam has been constructed, regular monitoring (including routine visual inspections) and maintenance should be carried out to minimise the risk of the dam failing and to ensure it maintains compliance with the relevant engineering codes.

Safe systems of work should identify and control any risks to workers and anyone else who may be affected by activities associated with ponds and dams (including adjacent landowners). This includes workers who need access to potentially hazardous areas for purposes such as carrying out inspections and cleaning out ponds or dams.

Inspections of ponds and dams by a competent person at regular intervals as determined by risk assessment (e.g. before the start of each working shift and at suitable times during the shift) should be carried out to check for changes to the dam or other signs of damage. At least weekly, every accessible area of the tip or pond, including areas with barriers, should be inspected by a competent person.

The most common failure mechanisms for a typical small earth dam are surface erosion from overtopping, internal erosion (i.e. piping or seepage) and embankment slumping. These failures can arise from defects such as spillway inadequacy, uncontrolled seepage, design and construction deficiencies, and a lack of maintenance.

If any of the following signs of damage or other unusual characteristics develop, immediate action should be taken to ensure safety and a technical expert contacted to investigate the dam to make sure it is safe and compliant with the applicable design and engineering codes.

10.1.1 UPSTREAM SLOPE

The upstream slope of an earth dam or pond should be examined for any sign of erosion, beaching or slumping. These may be caused by wave action, flooding, or a rapid drop in the water level.

A damaged upstream face reduces the stability of the dam by limiting its ability to resist wave action and high water levels.

Failure of the upstream slope can result from undercutting, erosion, depressions and other evidence of the initiation of a possible slip or rotational failure or landslide.

10.1.2 CREST

The crest of a dam should be examined for shape, deformation and cracks. A variation in surface levels across the top of the dam may indicate abnormal settlement (vertical downward movement) or possibly an underlying void or zone of super-saturation. Undetected, this may lead to the eventual failure of the dam wall structure by the progressive development of internal erosion or other failure mechanisms.

10.1.3 DEWATERING OR OVERFLOW CHANNELS

Dewatering channels should be checked for weed growth and side collapses. Safety issues include edge collapse while inspecting, silt build-up in the channel, and vegetation hiding undermined edges.

Overflows can be decanting pipes, angled pipes, spillways and armoured channels. These should be inspected regularly, particularly during and after periods of high rainfall.

Inspections should include checking for blocked intakes of decant or angled pipes with vegetation or other debris. A significant hazard when clearing blocked intakes is the sudden release of water into the pipe which can suck a person onto the intake causing injury or drowning. Blockages should only be cleared with machinery or tools that keep a person away from the intake zone.

Partially blocked overflow channels should be cleared quickly and safely. Remedial measures to limit the amount of floating vegetation in ponds should be established. Make sure armoured channels are not scoured when there is high water flow as this can erode the dam crest and affect the integrity of the embankment.

10.1.4 DOWNSTREAM SLOPE

Ideally, an inspection for seepage should be made when the water is at or near its highest level. Examine the downstream slope, downstream toe, abutments, areas near spillways and around and adjacent to outlets.

Seepage areas can be identified by wet spots or muddy areas, usually accompanied by the lush growth of tussock and other grasses.

The use of piezometers will greatly increase the ability to detect seepage at early stages and should be considered as a control. A specialist technical advice is required for the type and placement of each piezometer.

Small amounts of steady seepage (not concentrated flows) do not necessarily represent a serious condition as long as controlled drainage is provided and ponding is not allowed to occur. An area of known seepage that suddenly stops or significantly decreases may indicate an area of distress and should be investigated.

10.2 TECHNICAL OPERATIONAL REVIEW

Periodic technical reviews should be undertaken by a competent person to assure the tip or pond is operating in accordance with the design intent. This can also ensure that regulatory requirements are being met (including those required by the relevant engineering codes). Inspections and audits form part of this review using input parameters derived from site measurements, observations and testing.

Technical reviews:

- > check that previous review recommendations have been actioned
- > confirm appropriate responses have been made to any incidents or issues arising
- > verify compliance with specifications (e.g. inspection, monitoring, quality control)
- > verify compliance with legislative requirements
- > validate the continued use of the tip or pond design
- > recommend any necessary operational or design modifications.

The type and level of information provided in the review should be in line with the tip and/or pond risk appraisal.

A record of review outcomes should be maintained that should indicate any recommended actions and details of how they were addressed or implemented.

10.3 CLEANING OUT PONDS

The main risks when cleaning out ponds are created by undercutting and making the embankment unstable (particularly below water) or by mobile plant driving onto soft ground that cannot support the plant's weight.

Settling ponds can be deceptive, as they can form a crust that appears stable but the silt remains soft beneath. Access onto the silt should not be permitted unless it has been capped and stabilised. Mobile plant should be kept back from the edge by at least a distance of 1.5 times the height of the face (refer to Figure 55).

A risk assessment should be carried out to identify the appropriate methodology and plant to undertake silt extraction. The most common method is silt removal by an excavator (often a long-reach type). Alternative methods include dredges, suction pumps or vacuum pumps.

When using mobile plant, plant operators should constantly monitor the crest of the pond for signs of slumping, cracking or instability. If any signs of instability are observed, all work should stop, workers and plant removed and access prohibited. Seek geotechnical advice if required.

The mobile plant operator should only remove silt as planned and not excavate the pond retaining structure. The edge of the silt pond should always be clearly demarcated, ideally by barriers such as a bund. The mobile plant should be positioned as far from the lagoon edge as operationally possible and should be capable of obtaining the necessary depth of dig while maintaining the required stand-off. The mobile plant's tracks should be perpendicular to the pond edge so a safe, rapid exit from the area can be made if slope instability develops.

The excavated silt should be cast as far away from the crest of the pond as possible to prevent loading of the crest that could cause failure. Silt placement should not block the safe exit route of the mobile plant. When not in use, all mobile plant should be parked at a safe location away from the water's edge.

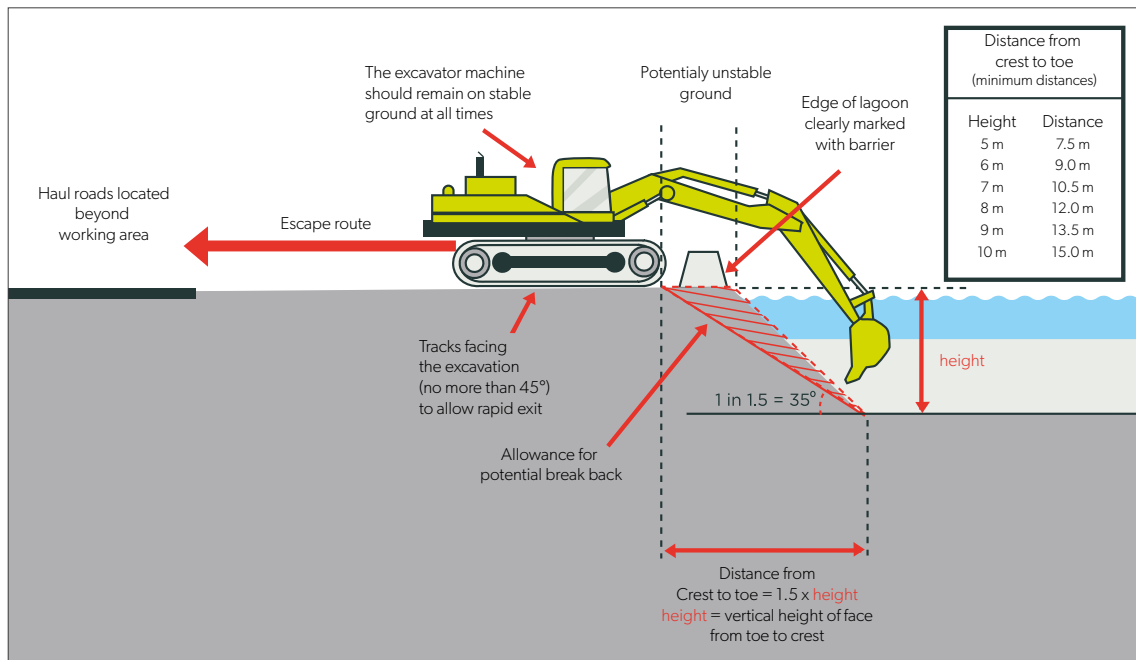

Figure 55. Example of cleaning out a settling pond with an excavator

11

PART C

Traffic management

IN THIS SECTION:

- 11.1 Site access: contractors, visitors and public**
- 11.2 Power lines and other overhead structures**
- 11.3 Reversing, manoeuvring and parking**
- 11.4 Loading vehicles**
- 11.5 Loading floating plant**
- 11.6 Loading and storage of large stone slabs or blocks**
- 11.7 Feeding crushers**
- 11.8 Railway sidings**
- 11.9 Safe drivers and vehicles**
- 11.10 Maintenance and repair of roads**
- 11.11 Cleaning trailers fitted with tailgates**

Any vehicle movement can pose significant risks at extractive sites, because of the size of the vehicles used and the working environment.

This section describes traffic management measures for:

- > moving around hazards
- > keeping safe speeds, distances and manoeuvres
- > using safe and appropriately trained drivers
- > selecting and maintaining suitable vehicles.

There are several ways vehicle activities can present a risk to workers at an extractives site. These include:

- > the failure of a roadway (e.g. a collapse or slip)
- > interactions between vehicles and pedestrians, vehicles and structures or vehicles and vehicles (e.g. vehicles carrying passengers or light and heavy vehicle interactions)
- > the loss of vehicle control (e.g. the driver falling asleep, mechanical failure or tip over)
- > the extent of hazards on the roadway (e.g. sharp corners, steep inclines, drop-offs or traffic volume)
- > other hazards involving vehicles (e.g. fire, explosion or visitor vehicles).

Adequately consider the following in the design, layout, operation, construction and maintenance of every road within the mining operation:

- > mobile plant characteristics, including stopping distances and manoeuvrability
- > operating speeds, driver position, driver line of sight and remote control mobile plant
- > the effect on road conditions of expected environmental conditions during operating periods (including time of day, weather, temperature and visibility)
- > the impact of road design and characteristics, including grade, camber, surface, radius of curves and intersections
- > the impact of mine design, including banks and steep drops adjacent to vehicle operating areas
- > the volume and speed of traffic and the potential for interactions between mobile plant with different operating characteristics, including heavy and light vehicles
- > the potential for interactions between mobile plant and pedestrians, including consideration of park up areas and driver access
- > the potential for interaction between mobile plant and public traffic
- > the potential for interaction between mobile plant and fixed structures, including overhead and underground power lines, tunnel walls and roofs.

11.1 SITE ACCESS: CONTRACTORS, VISITORS AND PUBLIC

On entering the site, vehicles and pedestrians should be directed to a safe area to park and, depending on the nature of their visit, undergo a site induction. This is usually achieved by signs but may include road marking, footpaths or barriers. Allow sufficient parking spaces for workers and visitors.

Where site vehicles cross a footpath or turn from or onto a public road, consider public safety. This may involve discussions with the local council or Roads and Maritime Safety (RMS) as part of the planning process.

11.1.1 CONTRACTORS AND VISITING DRIVERS

Carefully consider contractors and visiting drivers who are required to access operational areas. Assess their needs and, where applicable, induct them to ensure they are aware of the site rules and procedures and what is expected of them.

For example, light vehicles (such as maintenance vans) are invariably required to attend breakdowns in operational areas. Give the visiting driver the traffic management plan or escort them so their movements and operations are strictly controlled.

Regardless of the size of the site, establish safe systems of work that could include vehicle visibility standards (refer 11.9.4), induction systems and signs as required.

11.1.2 PEDESTRIAN SEPARATION

Pedestrian activity in operational areas should wherever practicable be restricted, particularly in the hours of darkness. Workers should not enter operational areas as a pedestrian unless authorised to do so.

Pedestrians must use separate routes wherever practicable (e.g. pedestrian only areas and safe, designated pedestrian routes (refer Figure 56)). Other controls may include using light vehicles to transport workers to their place of work or, only allowing pedestrians to enter areas when vehicles are stationary (e.g. lunch breaks). Where separation by time is used as a control, check pedestrians have moved out of the area before operations recommence.

For smaller sites or where only a few people are working, holding areas may be appropriate (e.g. signage stating visitors are to remain at the site office until authorised to proceed).

Install a sign to inform people of prohibited zones (refer Figure 57).

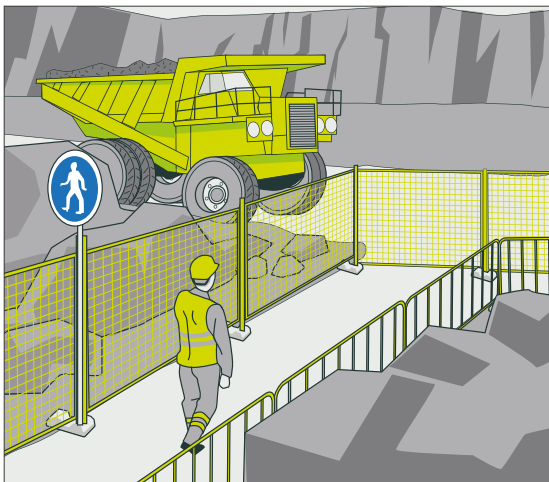

Figure 56. Example of pedestrian route



Figure 57. Example of signage for small sites

11.2 POWER LINES AND OTHER OVERHEAD STRUCTURES

11.2.1 OVER HEAD POWER LINES

Overhead power lines on a site are likely to pose a significant risk unless they are sufficiently high enough so that vehicles and equipment cannot approach or contact them. Vehicles do not need to strike the overhead lines for injury to occur – electricity can arc a significant distance depending on the voltage and conditions, so maintaining clearance distances is very important.

The most effective way to prevent contact with overhead lines is by not carrying out work where there is a risk of contact with or close approach to the overhead wires. Roads should be routed to avoid them. If there is a risk and the road or working area is permanent (or long-term), consult the asset owner to find out if the line can be permanently diverted away from the work area or replaced with underground cables. If this is not practicable the following guidance applies.

Use precautions such as those illustrated in Figure 58 if it is possible for a vehicle to reach the danger zone around the cables. In risk assessment, consider the possibility of vehicles travelling with a raised tray.

(Note: a risk assessment is required to enable the development of the electrical engineering control plan and overhead power lines will be a part of that plan as well as roads and other vehicle operating areas.)

Approach distances vary with the voltage of the power line. It is best to have a blanket single distance for your mine site. For voltages up to 132,000 volts an accepted distance is no closer than four metres to the overhead power line. For more detailed information on approach distances see SafeWork Australia *General guide for working in the vicinity of overhead and underground electric lines*.

Where vehicles are likely to be used at any time in the proximity of overhead power lines, a permanent sign must be installed in a conspicuous place as near as practicable to the driver's position. The sign should be maintained in a legible condition and must state "Warning: Keep clear of power lines" and include the distance to and the voltage of the power lines. For mobile crushers or transportable conveyors, the sign should be installed in a conspicuous place at each towing point and adjacent to driving controls and state the height of the plant.

If work needs to be carried out below power lines and it is possible that vehicles could reach into the danger zone, the power lines should be isolated and earthed before work begins. If this is not practicable, physical safeguards such as chains on the booms of excavators may be required to prevent vehicles reaching into the danger area.

Emergency procedures should outline what to do in the event of making contact with an overhead power line (refer Section 18). The procedure should include the operator not exiting the plant and waiting until the vehicle has been isolated and made safe, in order to manage the potential risk of electrocution or tyre explosion.

Most power line asset owners have information available on their websites for working around overhead and underground power lines. One example is available from http://www.safework.nsw.gov.au/___data/assets/pdf_file/0020/52832/Work-near-overhead-power-lines-code-of-practice.pdf

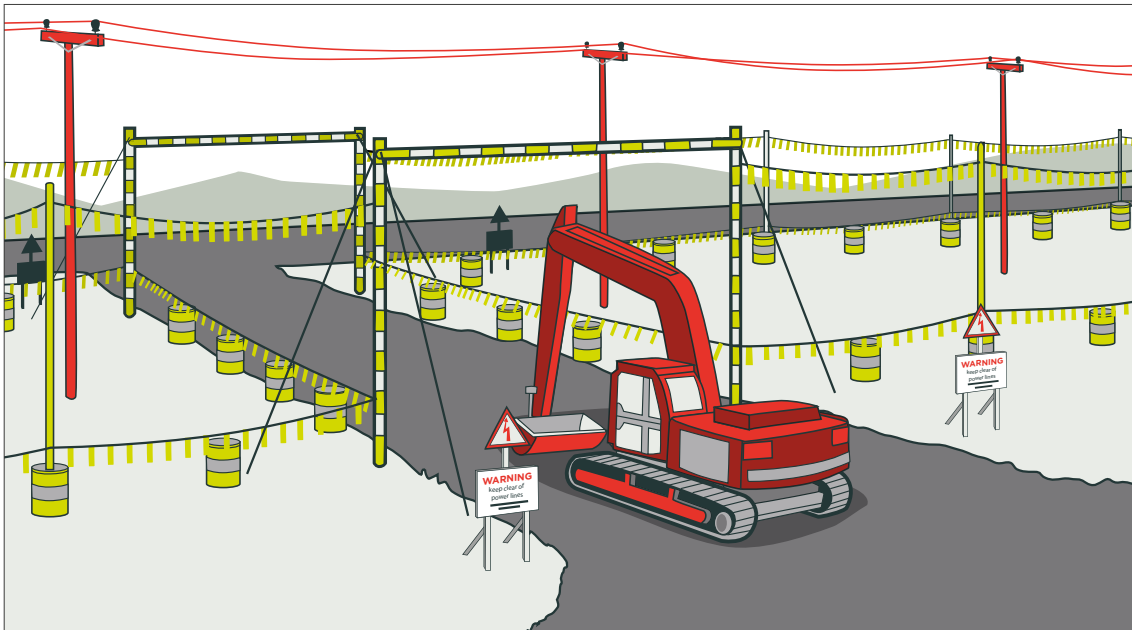

Figure 58. Safe working under overhead power lines

11.2.2 OTHER OVERHEAD STRUCTURES

Measure and record the vertical clearance under overhead obstructions on routes.

The measurement should take account of any underhanging lighting, ventilation or other service features, which are often added after the initial design. Routes used by vehicles should allow for sufficient overhead clearance. Vehicle routes should also avoid anything that might catch on or dislodge a load.

Protect any overhead obstructions (such as electric cables, pipes, conveyors, walkways and so on) using goalposts, height gauge posts or barriers.

Give clear warnings of any limited width or headroom in advance and at the obstruction itself such as signs or audio warnings. Position these warnings at a sufficient distance from the structure so any vehicles can stop in sufficient time if they are oversized. For more information about signs refer section 5.3.16.

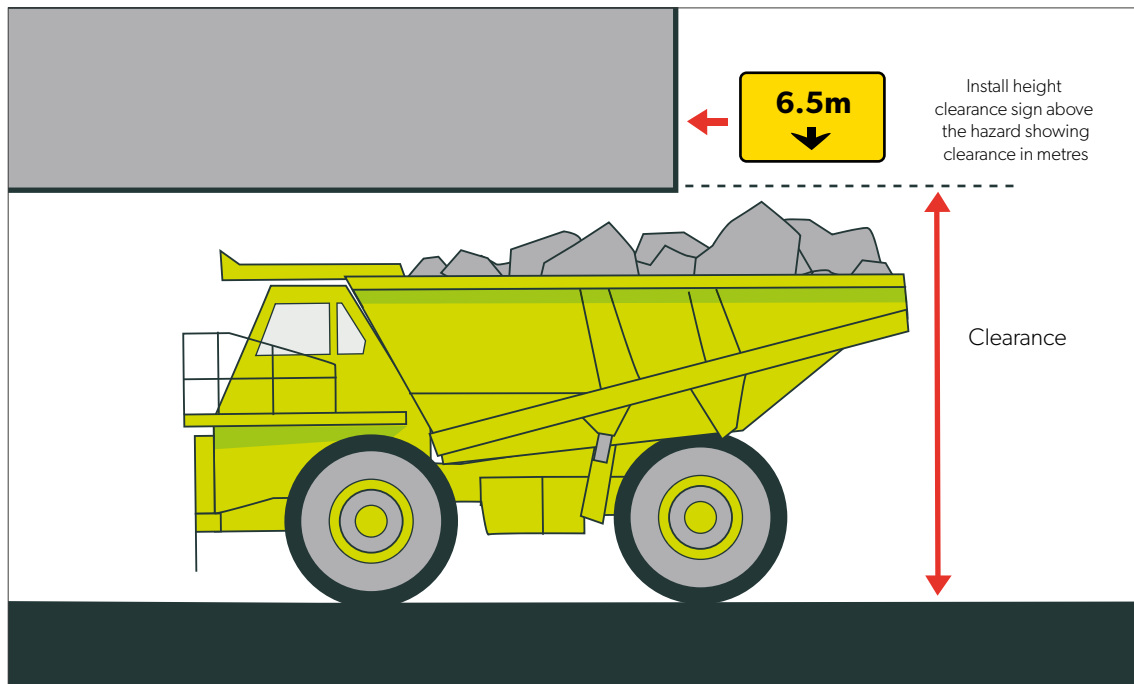

Figure 59. Example clearance signage and placement

11.3 REVERSING, MANOEUVRING AND PARKING

Reversing is hazardous because the driver has reduced visibility and is in an awkward driving position.

The most effective way of reducing reversing incidents is to use one-way systems and turning bays. Where this is not practicable, organise sites to keep reversing to a minimum. Where reversing is necessary, consider the following:

- > ensuring adequate visibility for the driver
- > installing engineering controls (i.e. collision avoidance equipment)
- > installing reversing cameras, proximity detection equipment and reversing alarms
- > providing safe systems of work
- > providing adequate supervision and training.

Where safe reversing relies on reversing aids (such as reversing cameras) the vehicle should not be used if they are defective. Temporary controls could be used to ensure safety (e.g. using a spotter).

When it is dark, site lighting and vehicle lights must provide sufficient light for the driver to see clearly when reversing.

No single safeguard is likely to be sufficient on its own during reversing. Consider all the relevant precautions together (see Table 9).

TYPE OF CONTROL	EXAMPLES OF CONTROLS
Eliminate need to reverse	<ul style="list-style-type: none"> > Implement one-way systems around site and in loading and unloading areas > Provide designated turning areas
Engineering controls	<ul style="list-style-type: none"> > Fit collision avoidance equipment that warns the operator of the presence of a pedestrian, object or another vehicle and stops the vehicle from operating when an object is within the collision zone
Reduce reversing operations	<ul style="list-style-type: none"> > Reduce the number of vehicle movements as far as possible > Instruct drivers not to reverse unless absolutely necessary
Adequate visibility and proximity devices for drivers	<ul style="list-style-type: none"> > Fit reversing cameras, radar, convex mirrors and so on to overcome restrictions to visibility from the driver's seat, particularly at the sides and rear of vehicles > Fit proximity devices to warn the driver of possible collision with an object or person
Make sure safe systems of work are followed	<ul style="list-style-type: none"> > Design vehicle reversing areas which: <ul style="list-style-type: none"> – allow adequate space for vehicles to manoeuvre safely – exclude pedestrians – are clearly signed – have suitable physical stops to warn drivers they have reached the limit of the safe reversing area – make sure everyone on site understands the vehicle rules > Fit all vehicles on site with appropriate warning devices such as: <ul style="list-style-type: none"> – reversing alarms – having controlled (or supervised) reversing systems such as the excavator – operator controlling the truck coming in to be loaded – using spotters – checking that procedures work in practice and are actually being followed

Table 9. Control measures for reversing options

11.3.1 SPOTTERS

A spotter's (or signaller's) job is to guide drivers and make sure reversing areas are free of pedestrians or other hazards.

If you are using spotters, make sure:

- > only trained spotters are used
- > they are clearly visible to drivers at all times
- > a clear and recognised system of communication is adopted
- > they stand in a safe position throughout the reversing operation.

You must establish a safe system of work so anyone leaving a vehicle does not enter a hazardous area. This includes when operators are undertaking daily start-up inspections and shift changes.

11.3.2 FOLLOWING DISTANCES

Ensure vehicles follow one another at a distance that provides adequate separation. If a vehicle follows another vehicle too closely, an accident can occur if the driver in the trailing vehicle doesn't react as fast as the lead driver in a stop situation. This can also happen if the trailing vehicle cannot stop as effectively as the lead vehicle.

There are many factors that contribute to the separation distance. As vehicle speeds increase, the following distance should be lengthened to provide the necessary level of safety. Drivers should increase their following distance in conditions where the sight distance is reduced (i.e. foggy conditions) or when road conditions may result in a longer stopping distance (e.g. in wet weather).

Consider the speeds on both level roads and grades, and establish following distance rules that provide for safe distances in all situations, with vehicles loaded and unloaded.

The following distance rules should be kept in the site traffic management plan or the roads and other vehicle operating areas PHMP.

Visual aids can be used to determine following distances (e.g. spacing road marker pegs at the site's following distance rule).

11.3.3 STOPPING DISTANCES

The distance a vehicle needs to be able to stop is made up of three elements:

- > the distance travelled during the operator's reaction time
- > the distance travelled during the brake's response time
- > the distance the vehicle travels before coming to a stop.

Quite often the original equipment manufacturer (OEM) will only specify braking distance as specified in element 3.

The distance of the sum of all three elements should be allowed for when determining the overall stopping distance for vehicles. Gradients and wet conditions will also have a significant effect on element 3 and should always be factored into calculations which are provided in OEM braking data.

The load on a vehicle, traction and how the brakes have been applied (soft, medium or hard) also affect the stopping distance of a vehicle.

In areas where excessive stopping distances are calculated, speed restrictions may be required to make sure the final calculated stopping distance meets acceptable operational requirements.

11.3.4 PARKING

Vehicles should be parked on level ground wherever practicable to eliminate the possibility of the vehicle inadvertently being set in motion. Vehicles parked on slopes should never be left unattended. To prevent the vehicle from accidentally moving the wheels should be secured, chocked, blocked or angled against a suitable bund or parked with wheels in a purpose-built contour.

You should develop a safe system of work for leaving a vehicle unattended. For example, requiring drivers to switch off the engine, remove the ignition key, apply all brakes and so on. For mobile plant this may include lowering ground engaging equipment (i.e. excavator buckets, dozer blades, ripper teeth and scraper bowls) to the ground. Vehicles should never be parked in the swing radius of an excavator or the manoeuvring zone of other operational vehicles unless in accordance with a safe system of work.

When it is necessary to park light vehicles close to heavy vehicles (e.g. for maintenance purposes) the heavy vehicle should be parked before the light vehicle enters the area. The heavy vehicle should remain immobilised throughout the operation. This immobilisation should be controlled by an isolation procedure.

PCBUs must ensure plant, including vehicles, are only operated by competent people unless adequately supervised. This may mean ensuring keys or any other devices for starting vehicles are in a secure place while parked.

11.4 LOADING VEHICLES

Loading, for the purposes of this section, refers to the loading of vehicles with excavated material by mobile plant. For information on safety when loading mobile plant or equipment (or other loads) from transporters or trucks, see the Safework NSW Safety in the road freight transport industry guide. A short video by WorkSafe Queensland: Loading and unloading mobile plant is also available. For information on loading floating plant see section 11.5.

Depending on the nature of the site, loading may be into haul trucks, truck and trailer units, utility vehicles or car trailers (e.g. where selling of product is directly to the public).

11.4.1 LOADING ZONES

It is recommended that the loading zone (or prohibited zone) be a minimum of six metres around the truck, trailer or mobile plant. This zone may need to be larger, depending on the visibility of vehicles or traffic movement associated with loading (refer to Figure 60).

In addition to the loading zone, restricted zones should be established based on a site-specific risk assessment which considers the movement of vehicles associated with loading.

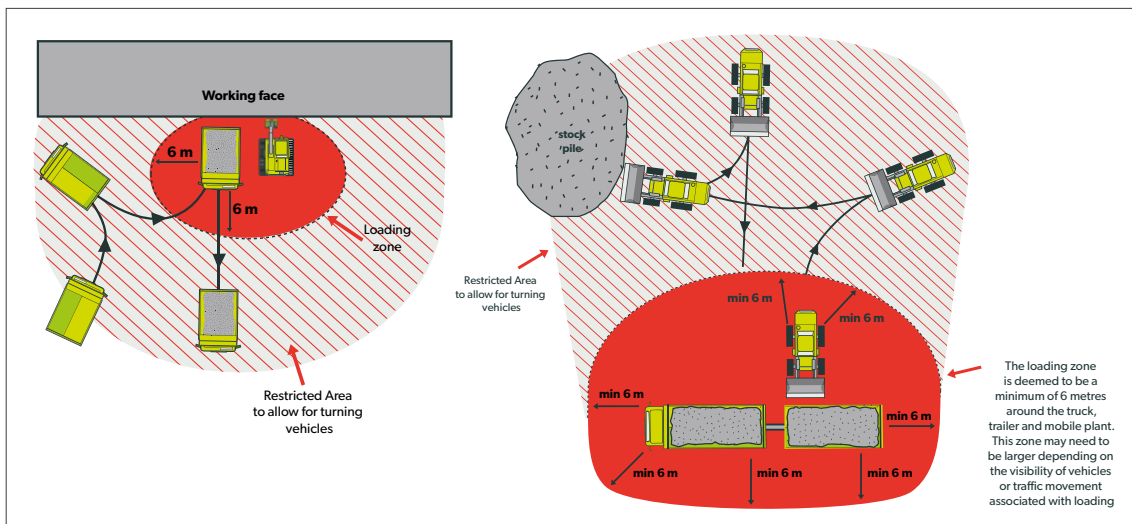

Figure 60. Loading and restricted zones

The entry of any vehicle (other than those being loaded) or pedestrians into a loading zone while excavation and loading operations are active should be prohibited.

You should determine a safe system of work that specifies communication protocols for vehicles entering the loading zone (to be loaded). For example, the system could specify that contact is required to be made with the mobile plant operator to request permission before proceeding into the loading zone. This can be co-ordinated by a supervisor or other designated person in control of traffic movements. The safe system of work should also specify steps to be taken, including the immediate suspension of works, if a vehicle or pedestrian enters the loading zone without prior permission.

11.4.2 LOADING OPERATIONS

When identifying the hazards with loading, insecure loads and overloaded vehicles can present a significant hazard whether on a public road or a road within the confines of the site. The *Heavy Vehicle National Law* (NSW) (HVNL) contains the load security legislation for vehicles driven on public roads. It provides strict liability for offences involving insecure loads and loads falling from vehicles. The HVNL details the general requirements to secure a load and applies to the operator or any person loading the vehicle. Loads must be secured and remain safe while loading, while the vehicle is being driven and during unloading. When loading or unloading, the vehicle should be level, stable and stationary, apply all vehicle and trailer brakes and follow these principles:

LIGHT VEHICLES

- > Spread loads as evenly as possible during loading. Unbalanced loads can make the vehicle or trailer unstable or overload individual axles.
- > Prohibit loading over cabs unless the driver is out of the vehicle and away from the loading zone (i.e. in a safe area).
- > Avoid loading to the back of the trailer as this can cause the trailer to tip backwards (especially for single-axle trailers). This can reduce the grip the vehicle has on the road surface, as the wheels are lifted away from the ground.
- > Balance loads across the axle (or axles) so coupling or uncoupling can be managed easily and safely and the trailer is stable when being transported.
- > Ensure drawbars, body edges, chassis rails, etc are free of loose material that may dislodge and impact on other road users.
- > Wherever possible, couple (or uncouple) drawbar trailers when unloaded as this makes them easier to handle and generally safer to work with.
- > Select suitable mobile plant or purpose-built devices (hoppers) to do the loading that reduce the risks to the vehicles, driver, other vehicles and pedestrians.

ON-ROAD VEHICLES

- > Spread loads as evenly as possible during loading or in accordance with axle load limits based on advice from the driver. Unbalanced loads can make the vehicle or trailer unstable or overload individual axles (see Figure 62).
- > Do not load over the driver's cabin.
- > All drivers (and where applicable, passengers) should remain in the vehicle during loading. If there is a risk to material falling onto the cabin, and the cabin does not have FOP fitted, then the driver and passengers should exit the cabin and retreat to a safe area before loading commences.
- > If the load is to be covered, an on-vehicle covering device that can be worked from ground level or a safe place higher up should be provided. Alternatively, a load covering platform or gantry should be used. For more information on covering loads refer section 16.3.

- > Loose loads normally rely on the vehicle body for restraint so it is extremely important to make sure all body-to-chassis attachment points (i.e. U bolts, hinge pins, hinge pin brackets etc) are not damaged, are secure and the attachment points and body are in sound condition.
- > Doors to bulk bins must be closed to avoid loose bulk loads from being blown out (see Figure 61).
- > When travelling on a public road, loose bulk loads should be covered whenever there is a risk of load shedding due to wind action or movement. Body work should be kept in good condition to minimise hazards during transportation.

Vehicles with badly fitted tail gates that permit gravel and stones to fall to the roadway should not be used until the tail gate is repaired (see Figure 61). Loose bulk loads being transported in a vehicle on a public road without a tarpaulin fitted should at no time reach higher than 100 mm below the top edge side of the vehicle (see Figures 61 and 62).

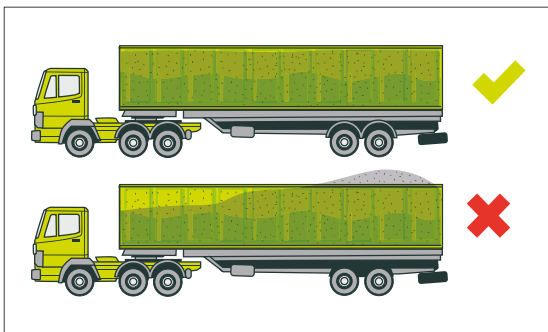

Figure 61. Loads should be spread evenly across the vehicle

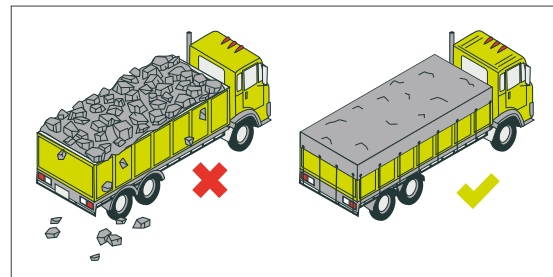

Figure 62. Cover loose bulk loads when travelling on a public road

Body height extensions (hungry boards) should only be used where conditions and type of load permit. In these circumstances, supports should be adequately fixed to the existing body. It is not adequate to rely on the load within the parent body of the vehicle for support. Where necessary, tie-chains should be used transversely at the top of body extensions to prevent sideways spreading of the hungry boards.

OFF-ROAD VEHICLES

- > Spread loads as evenly as possible during loading. Unbalanced loads can make the vehicle or trailer unstable or overload individual axles.
- > Prohibit loading over the cabs.
- > All drivers (and where applicable, passengers) should remain in the vehicle during loading. If there is a risk of material falling onto the cabin, and the cabin does not have FOPS fitted, then the driver and passengers should exit the cabin and retreat to a safe area before loading commences.
- > Loads should not be dropped from height to avoid people in the cab being thrown around or injured.
- > If particularly large rocks are being loaded, placing a fine material bed will provide some cushioning and stability.
- > The placement of loads should ensure they are secure and avoid spillage from tail gates.
- > The excavator or loader should be matched to the size of the truck being loaded.

11.4.3 WEIGHT LIMITS

Maximum vehicle and axle weights must never be exceeded (see Figure 59). Overloaded vehicles can become unstable and difficult to steer and be less able to brake.

Mining operations must include the maximum load that may be carried or towed by vehicles and equipment (whether by reference to weight, dimensions or other criteria) on their roads and other vehicle operating areas.

11.5 LOADING FLOATING PLANT

For information on loading floating plant see section 9.3.

11.6 LOADING AND STORAGE OF LARGE STONE SLABS OR BLOCKS

Transporting and storing large stone slabs or blocks carries a high risk of serious personal injury if not done safely. Due to their size and weight, such slabs or blocks are potentially unstable.

To ensure the safety of workers you must determine a safe system of work that includes:

- > Prohibition zones: not allowing people into an area where a slab or block may fall during transport or lifting.
- > Written work instructions (or standard operating instructions): Workers must be given appropriate information, instruction and training on the dangers of large stone slabs or blocks and the need to follow safe systems of work.
- > Adequate supervision by a competent person.

Always restrain slabs or blocks during loading or unloading operations (whether from vehicles or from storage). This should include attaching and detaching straps, lifting slings and so on. This is especially important when people may be in the hazardous area, where a slab may fall during lifting, and when loading or unloading vehicles (due to the variable and sometimes unpredictable effects of road camber or vehicle suspension).

- > Use only appropriate loading equipment (fork lifts, cranes etc) that are designed for the lifting requirement and are properly maintained and operated by competent personnel.
- > Providing, maintaining, using and inspecting appropriate certified lifting equipment.
- > Making sure loads are secured against movement while being transported.

When using rack type storage systems, they should be designed and certified to prevent slabs toppling over or slipping out from the base. Traditional A frame storage is not suitable in this context unless modifications have been undertaken that achieve the above goal.

11.7 FEEDING CRUSHERS

If the crusher is to be fed directly by a loader or excavator, then:

- > standing pads should be suitable (stable) and high enough for the operator to monitor the feed hopper from the cab
- > keep the ramp wide enough to allow for adequate edge protection (e.g. windrows) on either side of the ramp as well as the travel of the vehicle when using wheeled loaders or trucks

- > the maximum gradient of the ramp should be within the capability of the loading vehicle
- > the last few metres of the ramp should be level so the vehicle is not discharging uphill. This helps operators monitor the feed and the vehicle will be more stable
- > make sure pedestrians, other vehicles and obstructions are kept out of the excavator swing radius or loading area.

11.8 RAILWAY SIDINGS

Where raiing sidings enter a site:

- > where practicable, have a means of locking siding entrances
- > where practicable, have tracks separated from other operational areas using fences or windrows
- > have a safe system of work for communication about train arrival times and days (e.g. having the rail operator advise of train entrance at least 24 hours before)
- > make sure tracks are not obstructed and are kept clear of debris
- > where appropriate, put signs in place advising of train arrival and other hazards.

11.9 SAFE DRIVERS AND VEHICLES

Drivers must be competent, or adequately supervised, to operate a vehicle safely. They should receive appropriate information, instruction and training for the make and model of vehicles they use. It is particularly important that less experienced drivers are closely monitored following their training to make sure they work safely.

Protocols should be established that stipulate drivers and passengers must wear their seatbelts. Past incident have shown that staying in the cab with the seatbelt fastened is the best way to avoid a serious injury or death if a vehicle goes out of control.

11.9.1 TRAINING AND COMPETENCY OF DRIVERS

Drivers must be licenced to drive on a public road. The licence must be appropriate for the class of vehicle being driven. Periodically check that drivers have current licences.

Where drivers are required to drive on roads within the mine site, employ systems and procedures for training and verifying the competency for people to drive on site. These verification of competency records should be kept on site as a part of the training records.

Training requirements will depend on an individual's experience and previous training. All drivers should be subject to site specific induction rules and procedures. Risk assessment should help decide the level and amount of training a worker receives. In general, newly recruited drivers have the greatest training needs but there should also be a reassessment program for more experienced drivers.

It is important to assess information provided by newly appointed drivers, particularly in relation to training and experience. Monitor them on-site to establish both their actual level of competence and any further training needs.

Keep a record of training and licences for each driver to help ensure the most appropriate person is allocated to a task and identify those requiring refresher training.

Mine operators should authorise vehicle operators or drivers in writing. Authorisation to operate should be for every individual, for each vehicle type and model. For more information on training and supervision see section 20.

11.9.2 FITNESS TO DRIVE

A person's fitness to drive a vehicle should be judged on an individual basis, but the aim is to match the task requirements with the fitness and abilities of the driver.

Pre-employment health assessments and on-going health assessments should include assessment and monitoring that relates to an individual's ability to safely drive a vehicle (and undertake any associated tasks). Site health controls may require random alcohol and drug testing.

Detailed advice on medical standards of fitness to drive is published by the National Transport Commission and Austroads and have been adopted by all licensing authorities when assessing a licence holder's medical fitness to drive. The guidelines can be viewed on the Austroads website at www.austroads.com.au.

11.9.3 VEHICLE SUITABILITY

Vehicles must be suitable for the type of work being done and the place they are being used. Selecting suitable vehicles can reduce or eliminate many risks at the site. It is generally much easier and cheaper to start with the right vehicle than to modify it later. The following are minimum factors to consider before purchasing a vehicle:

- > the effectiveness of the braking system, bearing in mind the slopes on which it is expected to work
- > adequate all-round visibility for the driver
- > stability under all foreseeable operating conditions
- > protection for the driver and any passengers from falling objects (falling object protective structure (FOPS)), overturning (roll-over protective structure (ROPS)) and seat belts. Further information is available in the Australian Standard AS 2294.1 *Earth moving machinery – Protective structures*. (This Standard also has adopted in parts international standards ISO 3471 and ISO 3449, which are commonly used for vehicles manufactured overseas, and these are seen on the ROPS/FOPS compliance labels.)
- > safe access and egress to and from the cab and other areas of the vehicle where access may be required
- > adequate fall from heights protection when accessing and egressing the cab, as well as around working areas that are at elevated heights (e.g. engine bays)
- > engine firewall and fire suppression equipment
- > lights, windscreen wipers, horn and other warning devices (e.g. flashing lights and reversing alarms)
- > guarding for dangerous parts during use or maintenance work
- > protection for the driver and any passengers from rain, high and low temperatures, noise, dust and vibration
- > suitable seating for the driver and any passengers
- > maximum loads that may be carried or towed.

Where vehicles are not fitted with safety features, consider retro-fitting where the hazard identification and risk assessment process has recognised a significant hazard.

For vehicles expected to enter sites in darkness, whether or not work is scheduled to take place, additional supplementary lighting should be provided (i.e. forward and rearward facing spotlights) or additional vehicle-mounted work lights. Any permanently fitted lights must comply with the NSW Road Rules and the Australian Design Rules when being driven on public roads.

11.9.4 DRIVER VISIBILITY

Many vehicles have substantial blind spots, not only immediately behind the vehicle, but also alongside and immediately in front of it. Improving visibility requires a combination of approaches such as reversing cameras (see Figure 67), collision avoidance systems, proximity sensors and mirrors.

Studies suggest that, when used appropriately (i.e. drivers glance at the system at the appropriate time), reversing cameras can successfully mitigate the occurrence of reversing crashes, particularly when paired with an appropriate audible warning system.

One study⁵ found:

- > of those drivers that did not look at the rear-view camera before reversing, 46% looked at the camera after being audibly warned
- > of the drivers who looked at the rear-view camera display, 88% avoided a crash.

Accidents can occur when vehicles drive off or turn while a pedestrian or vehicle is passing or parked in a blind spot. As a guide, the driver should be able to see a one metre high object one metre away from any danger point of a vehicle. The driver should be able to detect the presence of other vehicles and pedestrians in their intended line of travel when moving off or when reversing.

Tests carried out for the American National Institute for Occupational Safety and Health (NIOSH) demonstrate blind areas in some typical mining vehicles. The illustrations in the report show the area around the operator where they cannot see obstacles. You can download the report or view the diagrams on-line at <https://www.cdc.gov/niosh/topics/highwayworkzones/>

(Note: some of these diagrams are based on vehicles that drive on the right-hand side of the road and may need to be modified for Australian driving conditions.)

There should be a procedure (commonly known as the 1-2-3 horn principle) to be followed before a vehicle drives off:

- > moving from being parked overnight or otherwise not in use – a single beep from the horn with a five second delay before driving off
- > moving from an operational area – two beeps from the horn, with a five second delay before driving forward
- > moving in reverse – three beeps from the horn with a five second delay before reversing

A CLEAR VIEW

Drivers should not place items in the windscreen or in the way of mirrors or monitors where they might impede visibility from the driving position. The area of the windscreen that is kept clear by the wipers should not be obscured, nor should the side windows. Windows and mirrors should be kept clean and in good repair. Dirt or cracks can make windows or mirrors less effective.

If necessary, fit additional side-mounted mirrors to increase the driver's visibility (refer Figure 63 and Figure 64).

⁵ Backing collisions: A study of drivers' eye and backing behaviours using combined rear-view camera and sensor systems, Hurwitz DS. et al (2010), Injury Prevention 16(79-84)

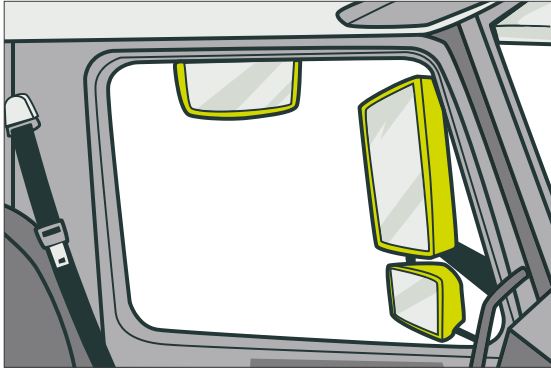

Figure 63. Side-mounted mirrors

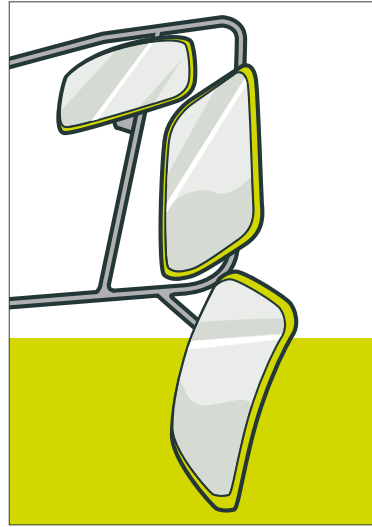

Figure 64. Side-mounted mirrors

COLLISION AVOIDANCE AND PROXIMITY DETECTION EQUIPMENT

Collision avoidance equipment warns the driver of fixed obstacles or other vehicles along the route, and stops the vehicle from colliding. Collision avoidance systems usually use GPS or local area wireless technology (i.e. WiFi or Bluetooth) to determine vehicle position, speed and heading. Vehicle locations and paths are calculated and sent via a radio link to all other outfitted vehicles in the area.

Where two or more vehicles may collide, audible and visual warnings are sent to the drivers to alert them to take evasive measures.

Proximity detection equipment warns the driver of the presence of people or objects in the immediate vicinity, but does not stop the vehicle from colliding (it relies on the driver to stop).

CLOSED-CIRCUIT TELEVISION (CCTV)

CCTV cameras can be mounted on the front, side and rear of a vehicle. Images are relayed to a screen located inside the cabin (see Figure 65). Some cameras are equipped with infrared illuminators so the driver has a comprehensive view even when it is dark. Thermal imaging systems are also available and may be suited to sites where night operations are a concern.

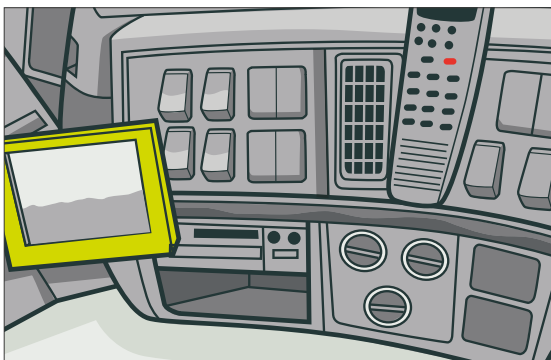

Figure 65. CCTV monitor in vehicle cab

REVERSING ALARMS

Reversing alarms warn anyone in the vicinity that the vehicle is in reverse gear. They rely on the driver having a clear view and the pedestrian or other vehicles moving out of the way.

Reversing alarms may be drowned out by other noise, or may be so common on a busy site that people do not take any notice of them. Using reversing alarms may be appropriate (based on a risk assessment) but will likely be most effective when used with other measures. Alarms can have different warning tones to meet environmental compliance requirements and still be effective in the intended zone of influence.

11.9.5 VISIBILITY OF LIGHT VEHICLES

Light vehicles are at risk of being crushed by heavy vehicles. They should be kept away from areas where heavy vehicles operate. Where this is not practicable they should be fitted with rotating or flashing beacons, high visibility buggy whips or flagged aerials, high visibility and reflective markings and other appropriate measures. This makes them readily visible to drivers of other vehicles. The use of vehicle hazard lights alone is not deemed adequate and should be discouraged as being the only warning provided.

For light vehicles expected to enter areas where heavy vehicles are operating, consider the following controls during your risk assessment:

- > Establish exclusion zones around heavy vehicles.
- > Heavy vehicles are to remain stationary when light vehicles are within exclusion zones.
- > The impact of environmental conditions on visibility (e.g. darkness, fog or rain).
- > Fit vehicles with rotating or flashing orange warning lights, visible 360 degrees from the vehicle, unless multiple lights are fitted to cover blind spots.
- > Fit vehicles with reflective strips.
- > Fit radios so drivers can communicate with each other, site supervisors and directly to heavy vehicle drivers.
- > Fit a warning flag (buggy whip) that can be seen by the operator of the tallest vehicle.
- > Fit clearly visible numbering, or an alternative form of positive identification, as an aid for identifying who you are during two-way communication between vehicle drivers.

Light vehicle visibility controls should apply to all light vehicles, including contractor and visiting drivers (where they are required to enter operational areas). Any permanently fitted lights, retro-reflectors or retro-reflective material must comply with the NSW Road Rules 2014 and the Australian Design Rules when being driven on public roads.

11.9.6 PROTECTION OF DRIVERS, OPERATORS OR PASSENGERS OPERATOR PROTECTIVE STRUCTURES (ROPS AND FOPS)

Operators of heavy vehicles are at high risk of serious or fatal injury by crushing if their vehicles roll over, tip on to their sides or objects enter the cab. Generally, the risk depends on the type of vehicle, the terrain and how the vehicle is driven. There's a low risk on flat, stable ground and high risk on steep or unstable ground or on work adjacent to embankments, excavations or working on top of old mine workings.

Fitting roll-over protective structures (ROPS) and wearing a seat belt can reduce the risk of serious or fatal injury in the event of a roll-over or tip-over. Where there is risk of objects falling onto the operators or entering the driving position (such as rock falls), the operator also needs the security of a falling object protective structure (FOPS).

Under clause 215(2) of the WHS Regulation, PCBUs must ensure, so far as is reasonably practicable, that a suitable combination of operator protective devices for the plant is provided, maintained and used. If tractors are used they must be fitted with ROPS (clause 216 WHS Regulation).

For more detailed information on design and types of operator protective structures, refer to AS 2294.1 *Earth-Moving Machinery – Protective Structures – General*; also refer to NSW Guideline (MDG15) for *Mobile and transportable plant for use on mines and petroleum sites*.

SEAT BELTS

All drivers and passengers should wear appropriate seat belts. They should be checked as a part of regular maintenance and the vehicle should not be used if:

- > the buckles are not working properly
- > the belt is damaged
- > the belt is frayed
- > in use alarms are defective.

Specific legal requirements under the NSW Road Rules 2014 for safety belts have changed over the years, and differ depending on the age and type of vehicle. The type of belt has also changed from static belts to retractor belts. For more detailed information on seat belts for vehicles, see the Australian Design Rules.

For more detailed information on seat belt requirements for vehicles fitted with operator protective structures see the NSW Guideline (MDG15) for *Mobile and transportable plant for use on mines and petroleum sites*.

TRANSPORTING PEOPLE

People should only be transported in vehicles designed to carry passengers with forward or rear facing seats and seatbelts. These vehicles should also comply with vehicle visibility standards (see section 11.9.5). Vehicles not specifically designed for carrying people should not be used. Wherever practicable, carry loads separately from passengers. If the cab is not separate from the load area (e.g. a van), fit a bulkhead or cargo barrier between the load compartment and the cab. This should be strong enough to withstand a load shifting forwards in an emergency.

Secure small equipment (e.g. fire extinguishers or tools) which may become missiles in the event of a collision.

11.9.7 VEHICLE FIRES

Typical causes of fires on or in vehicles include component failure and poor or inadequate maintenance. When completing a risk assessment for prevention of fires consider:

The design – for example:

- > Hydraulic components are like for like and considered suitable for use. Always consult the original equipment manufacturer(s) (OEM) before making changes.
- > Any maintenance, installations or design modifications that are undertaken off-site are verified before use and are equivalent to the OEMs standards and design.
- > Implementing quality checks or audits by OEM authorised service providers periodically as a cross check for site maintenance.
- > Using low flammability hydraulic fluids.

(Note: Low flammability and mineral hydraulic fluids should never be mixed. If you are replacing one with the other ensure a flushing product is used and no residual product remains.)

The installation – for example:

- > Properly fitting any attached or in situ hoses with approved OEM components.
- > Maintaining hydraulic equipment with the appropriate fit for purpose tools.
- > Routinely checking hose clamps for security.
- > Routinely checking for wear of hoses or rigid pipes underneath clamps.
- > Using fire resistant hoses and high temperature tolerant hoses designed for oil operating temperatures greater than 150°C.
- > Installing and evaluating insulation around hot components or insulating hoses near hot components and upgrading to braided armour type hoses.
- > Protecting wiring against fire and making sure connections are appropriate to OEMs requirements and are suitably located.
- > The location and rating of protective devices such as fuses, solenoids and non-return valves.

Inspection and maintenance – for example:

- > Completing pre-start checks for locating and acting on oil leaks, sprays, stains and bird nests.
- > The maintenance work order system includes the correct selection, integrity and testing of control measures.
- > Using thermal imaging equipment to detect hot spots and high temperature areas of plant during maintenance programs .
- > Routinely washing, cleaning and checking hoses for any sources of rubbing, oily mist or leaks.
- > Carrying out periodic checks on hydraulic braking systems to ensure sound operation, including bearings, brake drums, rotor and callipers.
- > Routinely checking electrical wiring including insulation.
- > Routinely checking solenoid connections for corrosion and replacing or checking at set engine hours or as per OEM recommendations.
- > Protective devices for solenoids such as fuses.

Emergency preparedness – for example:

- > Installing suitable and sufficient firefighting equipment (i.e. fire extinguishers). The type of fire extinguisher will depend on the class of fire you are most likely to experience. For example, powder ABE fire extinguishers are suitable for flammable and combustible liquids, flammable gases and energised electrical equipment. Fire extinguishers need to be readily accessible and located away from high risk fire sources.
- > Communication of fire-related events, maintenance incidents and subsequent attendance and associated follow-up is clear to workers.
- > Fitting appropriate automatic or manually operated fire suppression and engine or fuel pump shutdown systems.
- > Fitting mobile plant with a battery isolation switch and, where practical, a fuel isolation system.

11.10 MAINTENANCE AND REPAIR OF ROADS

Roads and other vehicle operating areas should be regularly maintained so they do not develop bumps, ruts or potholes. These may make control of vehicles difficult or cause health problems due to whole body vibration. In addition, excess mud and slurry can seriously affect the manoeuvrability, steering control and braking potential of the vehicles using the road and other vehicle operating areas.

DUST SUPPRESSION

Dust generated by moving vehicles can reduce visibility to dangerous levels and introduce a health hazard. Dust is typically reduced by applying water to the road surface.

In dry conditions, watering helps maintain compaction and surface pavement strength. It also maintains the pavement shape, reduces the loss of gravel and helps reduce corrugation of the road surface.

The quantity of water needed to control dust depends on the nature of the road surface, traffic intensity, humidity and precipitation. During drier months, a typical road may require one to two litres per square meter per hour. Liquid stabilisers and polymers can also be used, which can help strengthen the surface layer, reduce water usage and provide a degree of water proofing.

SAFETY WHEN WATERING ROADS

Watering roads to suppress dust has the potential to create vehicle accidents. The water tanker could turn over or the roads could become slippery because of wet bends, downgrades and any other sections of road where brakes may be applied (i.e. intersections). Water tanker drivers should avoid driving across gradients and should turn around in areas that are flat or are of minimal grade.

Due to the potential increase in instability of trucks carrying fluids, tanks should have baffles installed to help prevent movement of water inside the tank. It is recommended that where possible only rigid chassis trucks are used for water trucks as articulated trucks have higher turnover risks.

'Patch' or 'spot' spray roads and avoid blanket spray or excessive amounts of water being deposited on the roads (especially in braking areas, gradients and junctions of haul roads). It is recommended water tankers are fitted with systems that can be effectively controlled by the operator to manage water output. Procedures for watering roads should detail actions to take when roads have been excessively watered, reducing traction. This is particularly important on haul roads. Where possible, water tankers should be filled at the lowest point and dust suppression applied travelling up hill. This will avoid fully loaded water tankers travelling downhill.

11.11 CLEANING TRAILERS FITTED WITH TAILGATES

There has been fatalities and serious debilitating injuries caused by swinging tailgates hitting drivers while they have been cleaning out their trailers.

The mine should provide fit for purpose washing facilities for trucks, and prohibit all work that puts a worker in danger by allowing them to access a trailer in between the trailer body and the tailgate.

Trailers should have purpose-built access points and tailgates fitted with positive secondary support mechanisms.

The mine should communicate their site-specific requirements to all drivers, including mine site drivers and external trucking PCBU's.





**PART
D**

This part provides guidance for managing plant, worker health and facilities, site access and security, providing appropriate training and emergencies.

**TIER
ACK**

12

PART D

Plant and structures

IN THIS SECTION:

- 12.1 Scope**
- 12.2 Appraisal of machinery and equipment principal hazards**
- 12.3 Mechanical engineering or electrical engineering control plan**
- 12.4 Choosing and buying machinery and equipment**
- 12.5 Existing machinery or equipment**
- 12.6 Siting of Machinery**
- 12.7 Access routes**
- 12.8 Guarding**
- 12.9 Conveyors**
- 12.10 Emergency stops**
- 12.11 Pre-start warning systems**
- 12.12 Electricity**
- 12.13 Cranes and lifting equipment**
- 12.14 Pressure vessel equipment**
- 12.15 Lifecycle management of plant and equipment**

All sites use machinery and equipment in their day to day workplace activities. If the hazards associated with machinery are not safely managed, then serious injury and death can occur.

The overall message is – **safety in design**.

This section describes how to:

- > identify and manage plant hazards (for new and existing equipment)
- > position and guard plant
- > use prestart warning systems and emergency stop systems effectively
- > prevent, detect and deal with fires and explosions
- > manage electrical hazards
- > manage specific hazards around lifting equipment and floating equipment.

12.1 SCOPE

The scope of 'plant' as defined in the WHS Act is extremely wide. It covers almost any equipment used at the workplace including:

- > hand tools such as screw drivers, hammers and handsaws*
- > lifts, cranes, computers, machinery, conveyors, forklifts, vehicles, power tools
- > apparatus such as laboratory apparatus (e.g. Bunsen burners)
- > lifting equipment such as hoists, forklifts, elevating work platforms and lifting slings
- > other equipment such as ladders, air compressors and pressure water cleaners
- > an installation (a series of machines connected together)(e.g. a crushing plant and associated conveyor systems
- > any component of any of the above
- > anything fitted or connected to any of the above.

This section covers machinery and equipment commonly used at extractives sites. This section does not cover vehicles, including mobile plant (for information on vehicles see section 11).

The code of practice *Managing the risks of plant in the workplace* provides guidance on controlling risks of plant from initial specification and purchase through to disposal, as well as guidance on specific control measures required under the WHS Regulation.

* Plant that relies exclusively on manual power for its operation and is primarily supported by hand is not covered by the WHS Regulations. The general duty of care under the WHS Act applies.

This includes:

- > identifying hazards associated with plant
- > choosing, procuring (buying, hiring etc), installing, modifying and decommissioning machinery
- > eliminating hazards in the design process
- > specific machinery hazards
- > guarding types
- > use, inspection and maintenance of machinery
- > safe systems of work.

12.2 CONSIDERATION OF PLANT AND STRUCTURES PRINCIPAL HAZARDS

This chapter includes guidance on the mechanical engineering control plan (MECP) and the electrical engineering control plan (EECP). It may be possible that the use of plant and structures or some aspects of it contribute to a principal hazard of the mine.

Where the use of plant and structures contribute to a principal hazard, the design and operation of that item of plant or structure must be considered in the relevant risk assessment for the principal hazard. See section 2.5 and the Principal hazard management plans guide for further information.

When developing PCPs to manage risks associated with plant and structures at the mine it is necessary to consider the following:

- > how plant, structures or installations might fail and the likely consequences of any such failure (i.e. structural support collapse)
- > the type of fuel or energy used to power the plant, structures or equipment used at the site (i.e. electricity, gas, petroleum)
- > what the possible consequence of a loss of control situation would be (i.e. mechanical failure leading to uncontrolled release of hazardous substances or energy sources)
- > the hazards related to moving parts (i.e. draw-in hazards, nip points and entanglement hazards)
- > the hazards relating to suspended loads
- > the use of plant that is not fit for the purpose for which it is to be used
- > the hazards relating to surfaces (i.e. very hot or very cold)
- > working at heights
- > competency of workers.

If the degree of hazard is not clear, the advice of a specialist electrician, mechanic, designer, engineer or the machinery or equipment's original equipment manufacturer (OEM) should be sought.

12.3 MECHANICAL ENGINEERING AND ELECTRICAL ENGINEERING CONTROL PLANS

Clause 26 of the WHSMPS Regulation requires the mine operator to prepare and implement principal control plans for managing the risks associated with electricity at the mine and the mechanical aspects of plant and structures at the mine.

The requirements for both plans are similar and where equipment and machinery is powered by electricity, the plans should be coordinated to ensure there are no gaps.

(4) Mechanical engineering control plan⁶

The operator of a mine at which there is a risk to health and safety associated with the mechanical aspects of plant and structures at the mine:

- a. must prepare and implement a mechanical engineering control plan that sets out how the operator will manage those risks in accordance with clause 9 (of the WHSMPS Regulation).
- b. must ensure the plan is developed and periodically reviewed by a person who is, or who is under the supervision, of a competent person.

(5) Electrical engineering control plan⁷

The operator of a mine site at which there is a risk to health and safety associated with electricity at the mine:

- a. must prepare and implement an electrical engineering control plan that sets out how the operator will manage those risks in accordance with clause 9 (of the WHSMPS Regulation).
- b. must ensure the plan is developed and periodically reviewed by a person who is, or who is under the supervision of, the nominated electrical engineer. If there is no person nominated as the electrical engineer, then the EECp must be developed and periodically reviewed by a competent person (this can be the qualified electrical tradesperson).

The principal control plans must be documented and, so far as is reasonably practicable, be set out and expressed in a way that can be readily understood by the people who will use it.

The development of the mechanical engineering and electrical engineering control plans should be done in the context of being a part of the safety management system. They should not be developed in isolation from other plans, processes and procedures. This will ensure that gaps and overlaps in information and procedures are identified and are included in the overall compilation of and implementation of suitable controls to minimise the risks of mechanical and electrical hazards.

Both plans are required to be reviewed periodically. The reviews must be undertaken by a competent person, or someone supervised by a competent person (in the case of MECP), or by or under the supervision of the nominated electrical engineer or, if there is no electrical engineer, then by a competent person (for the EECp).

Both control plans must also comply with the requirements set out in schedule 2^{*} of the WHSMPS Regulation.

Schedule 2 sets out a range of matters to consider when developing control measures. You can use these lists to help make sure you have identified and managed the risks to health and safety from plant and structures. These are explained more in the following sections.

For more information on the content of principal control plans and their relationship with other management controls plans, processes and procedures, see the following codes of practice:

- > Safety management systems in mines
- > Mechanical engineering control plan
- > Electrical engineering control plan

⁶ Partial extract from clause 26 Principal control plans, Work Health and Safety (Mines and Petroleum Sites) Regulation 2014

⁷ Partial extract from clause 26 Principal control plans, Work Health and Safety (Mines and Petroleum Sites) Regulation) 2014

* Schedules are included at the end of a regulation in numerical order



12.3.1 MECHANICAL ENGINEERING CONTROL PLAN

The mechanical engineering control plan sets out the measures used to control risks to health and safety associated with mechanical aspects of plant and structures. Those aspects have individual hazards and in assessing the risks of those hazards and developing the control measures apply Schedule 2 of the WSHMPS Regulation.

Schedule 2 requires consideration of:

- > the overall life cycle of the plant and structures
- > reliability of safeguards during each phase of its life cycle
- > mechanical engineering practices at the mine
- > the competency required by workers in order to safely work on plant or structures at the mine.

Consider each of those items and determine what control measures need to apply to control the hazard by taking into account the following:

- > injury to persons caused by the operation of plant or by working on plant or structures
- > unintended initiation of explosions
- > unintended operation of plant
- > unintended release of mechanical energy
- > catastrophic failure of plant or structures
- > uncontrolled fires being initiated or fuelled by plant
- > exposure to toxic or harmful substances including the release of fluids under pressure.

In determining the control measures for each scenario above, consider the following:

- > the acquisition and operation of any plant or structure to ensure it is fit for purpose
- > the installation, commissioning, operation, maintenance, repair and alteration of plant or structures
- > the introduction of plant or structures into the mine
- > safe work systems for persons dealing with plant or structures including the isolation, dissipation and control of mechanical energy sources
- > inspection and testing of plant or structures including the testing of any braking, steering, warning systems and other safety critical functions or components
- > identification, assessment, management and rectification of defects
- > Diesel engine pollutants
- > risks associated with conveyors, face machines, winding systems, mobile plant, drilling plant and dredges
- > risks associated with pressurised fluids
- > risks associated with combustible liquids or volatile material
- > prevention, detection and suppression of fires on mobile plant and conveyors
- > operator protective devices on mobile plant
- > undertaking hot work.

Examples of some methods of controlling hazards from mechanical plant and structures are:

- > the standards of engineering practice that apply throughout the lifecycle of the mechanical plant and structures
- > fitting appropriate fire suppression and shut-down systems
- > fitting appropriate heat detection and automatic trip sensors
- > rollover and falling object protective structure
- > seatbelts and other restraints
- > safe storage and use of pressurised fluids (including gases)
- > means for the prevention, detection and suppression of fires on mobile plant and conveyors
- > truck mounted fluid storage tanks fitted with baffles.

See the *Mechanical engineering control plan code of practice* for full details of the requirements for and how to develop and implement an effective mechanical engineering control plan.

12.3.2 ELECTRICAL ENGINEERING CONTROL PLAN

The electrical engineering control plan sets out the control measures used to prevent injury from the risks to health and safety associated with electricity at the mine. Those aspects have individual hazards and, in assessing the risks of those hazards and developing the control measures, you need to apply Schedule 2 of the WSHMPS Regulation. Schedule 2 requires consideration of:

- > the lifecycle of the plant or equipment
- > reliability of safeguards
- > engineering practices
- > the required competencies of workers so they can work safely.

Consider each of those items and determine what control measures apply to control the hazard by taking into account the following:

- > injury caused by direct or indirect contact with electricity
- > injury caused by working on electrical plant or electrical installations
- > the unintended initiation of gas or dust explosions
- > the unintended operation of plant
- > the occurrence of uncontrolled fires.

In determining the control measures for each scenario above, consider the following:

- > the location of the electrical plant and installations
- > the rating and design of plant for prospective fault levels, load, arc fault control and operating frequency and voltage
- > design and operation of plant that contains flammable liquid
- > the selection, installation and use of cables and cable accessories
- > the control of static electricity, including preventing the ignition of flammable gas
- > impact of lightning
- > reliable circuit protection devices

- > type of earthing system used and if applicable the levels of earth fault limitation
- > the potential for people to contact electricity indirectly
- > prospective touch, step and transfer voltages
- > variation in operating conditions
- > persons inadvertently making contact with energised parts
- > consultation, co-operation and co-ordination with electricity supply authorities
- > procedures for using welders, electrical test instruments, working near overhead power lines and cables, treatment of electric shocks and electric burns and accessing high voltage installations
- > signs of risks at plant locations
- > security and maintenance of software and control circuits
- > use of lasers and fibre optic equipment
- > the use of battery powered vehicles and associated charging stations
- > the supply and use of plant in hazardous atmospheres.

Examples of some methods of controlling risks arising from using electricity:

- > secure enclosures with appropriate IP ratings
- > cables selected by applying Australian Standards selection of cables
- > by having all wiring on the surface adhere to the Australian Standard Wiring Rules
- > having a working maintenance management system
- > safe work practices for working on high voltage installations
- > any other requirements of the WHS or WHSMPS Regulations in relation to the safety management of electrical plant and installations and electrical engineering practices.

See the *Electrical engineering control plan code of practice* for full details of the requirements for and how to develop and implement an effective electrical engineering control plan.

12.4 ACQUISITION OF PLANT AND STRUCTURES

Prior to acquiring plant or structures, a risk based approach should be undertaken to determine the suitability and compatibility of the type of plant and infrastructure selected as part of the procurement process.

The risk management process should address as a minimum the following questions:

- > What is the intended use of the plant or structure? (e.g. operating environment, pay load requirements, maintainability etc.)
- > What are the potential scenarios for plant and infrastructure incidents?
- > What are their potential consequences in terms of safety and health?
- > What controls are available in terms of safety and health?
- > What controls are required to control the hazard?

The results of the risk assessments should be documented and the type of plant or structure procured should be based on these outcomes.

All operators should specify their expectations for achieving the requisite safety standards including the relevant standards and guidelines the plant is to comply with to the supplier and manufacturer.

The designer, manufacturer, supplier and PCBU's using the plant have obligations under the WHS Act and Regulation and should work together to manage issues such as:

- > identifying safety requirements
- > how the plant or structure is to be used in the workplace
- > standards required
- > how the life cycle of the plant or structure is to be maintained
- > type of guarding based on Australian Standards, exposure risk and work patterns
- > who will provide, install and commission the plant or structure
- > integration with other plant or structures
- > the working environment in which the plant or structure will operate
- > any hazardous exposures arising from use of the plant or structures such as noise or fumes
- > who will train and supervise the operators
- > operations and maintenance procedures
- > preventative maintenance and internal inspections required
- > potential blockages or out-of-the-ordinary situations
- > competency requirements of worker to operate and maintain plant
- > how isolation from hazardous energies can be achieved.

Where the plant or structure is being designed and manufactured in-house, the mine takes on the responsibilities of designer and manufacturer under WHS laws. These duties also apply when the mine modifies plant or structure. That is, the mine takes on the responsibilities of designer and manufacturer in relation to the modifications and any effect they have on the plant.

All plant and structures shall be designed by competent personnel with recognised expertise in their field.

The mine (the designer) must take into consideration what is reasonably practicable in relation to a duty to ensure health and safety, meaning which is, or was at a time, reasonably able to be done in relation to ensuring health and safety, taking into account;

- > likelihood of the hazard or risk occurring
- > degree of harm that may result from the hazard or risk
- > relevant legislation, codes of practice and standards
- > what the person knows, or reasonably ought to know about the hazard or risk associated with plant or structures and ways of eliminating or minimising the risk once assessed.

If newly purchased plant or structures are not safe because of the way it has been designed, constructed, supplied or installed, do not use it or stop using it until the unsafe aspects have been assessed and suitably rectified taking into consideration the hierarchy of controls. The manufacturer or supplier (or installer if relating to the installation) should be contacted to resolve the issue.

The mine should establish an introduction to site process to ensure that plant and structures are safe to operate at the mine.

12.5 EXISTING PLANT OR STRUCTURE

With changes in technology and cost of solutions over time, measures to eliminate or isolate a hazard (the higher order controls) may become practicable, reducing the dependence on lower order controls such as guarding or PPE. Plant or structures should be assessed either post incident or periodically to determine whether there are other methods to eliminate or minimise risks or hazards. For example, replace a machine with a newer (improved design) machine that eliminates the hazard.

Routinely review systems, engineering standards and procedures to reflect changes in technology and best practice.

Know what the hazards are with plant or structures in order to do something about them. (The first step in the hazard management process is to identify hazards – anything that can injure or harm someone.)

Do a workplace inspection to identify all plant or structures used. Include common items that may not normally be thought of as plant. Also consider how other workplace items such as steps or platforms, roads and traffic can affect the use of plant or structures.

Once all plant and structures are identified, then identify their hazards with consultation with the workforce.

Identify hazards using physical inspection, task analysis, process analysis, guidance and standards, hazard and operability analysis (HAZOP) and accident investigation analysis. In all cases, the WHSMPSR clause 9 requires assessment of each hazard on the likelihood of an incident occurring, the consequence if it does happen and to then apply the hierarchy of controls to manage that hazard.

All mobile plant should be assessed against the requirements of MDG 15 *Mobile and transportable plant for use on mines and petroleum sites* and AS/NZS 4871.6 *Electrical equipment for mines and quarries Part 6: Diesel powered machinery and ancillary equipment*.

For more detailed information on identifying, assessing and controlling hazards see the SafeWork Australia's *Managing risks of plant in the workplace code of practice*, the Resources Regulator's *Managing risks in mining* and Mining Design Guideline 15 *Mobile and transportable plant for use on mines and petroleum sites*.

12.6 LOCATION OF MACHINERY

As a general rule, activities such as crushing and screening are noisy and dusty and should be positioned away from site boundaries to lessen the potential nuisance value of the activities. Some noisy and dusty processes may need to be housed (enclosed) to control these effects.

Traffic should be routed away from plant wherever possible and plant should be sited away from other hazards (e.g. rock falls, overhead power lines).

Services including electricity, air and water should be included in a site layout plan, particularly when placed underground. Location plans (records) should be kept and maintained for all key services on the site whether they are installed underground or on the surface (e.g. overhead powerlines, services, phone lines etc). (Note: there are requirements in the WHSMPSR clause 32 and AS/ 3000 for having plans of electrical services at the mine.)

12.7 ACCESS TO PLANT AND STRUCTURE

Plant, including mobile crushers, often have areas where access at height is required to carry out routine operations, undertake maintenance or access elevated control rooms. This section deals with permanent (or fixed) access requirements (i.e. access to control rooms). For temporary access or machinery access see section 16.

SELECTING A MEANS OF FIXED ACCESS

When selecting a means of access to plant or structures it can be selected from the following list and considered in the hierarchical order given:

- a. Level walkway or access from ground level (from 0° to 3° from the horizontal).
- b. Sloping walkway with an angle nominally between 3° and 20° in the direction of travel.
- c. Stairs with an angle nominally between 20° and 45°.
- d. Inclined step-type ladders with an angle nominally between 60° and 70°.
- e. Inclined twin-stile rung-type ladders with an angle nominally between 70° and 90°.
- f. Single stile rung-type ladders with an angle nominally between 85° and 90°.
- g. Individual-rung ladders (step-irons) with an angle nominally between 80° and 90° to the horizontal.

Where a structure is a building under the *Building Act 2004*, you must provide reasonable and adequate access to enable safe and easy movement of people around plant or structures that may not be classified as buildings, but have as part of the design a means of access/egress (e.g. stairs, catwalks and work platforms). You must also comply with the relevant standards – generally AS 1657 for fixed plant and structures and AS 3868 for mobile plant.

General design inclusions

- > There should be no protrusion from any handrail, grab rail or guardrail. All transitions and bends shall be smooth and radii to avoid sharp corners or edges.
- > System shall not move under load.
- > The access system shall permit and encourage 3 points of contact (i.e. one hand two feet or two hands and one foot).
- > Systems should provide smooth and continuous flow paths.
- > All surfaces requiring access for general operation and maintenance purposes including step, treads and rungs shall be slip resistant.
- > All goings/leading edges from one level to another should be clearly highlighted for visibility in all lighting.
- > Steps should be designed to minimise accumulation of debris and be slip resistant on the tread surface and leading edges.
- > Lighting should be fitted to allow safe use of access where practical
- > Self-closing gates must be fitted to the top of all step type ladders, rung type ladders and from roofs
- > Gates shall not open outwards.
- > All platforms and walkways, including gates, above 2m shall have toe boards fitted.
- > All floors shall be evenly laid. Any variation in height between adjacent boards or plates shall not exceed 5 mm (Note: This does not apply to cleats on sloping walkways.)
- > All platform surfaces shall be securely fixed to the supporting structure and shall not rely on adjacent sections for the prevention of lateral movement. They shall be fixed so that the removal of any element or panel will not affect the security of the remaining sections.
- > Areas requiring routine maintenance shall be fitted with an access system.
- > The minimum headroom is to be 2000 mm. In applications where this cannot be achieved, other measures are to be taken to protect the health and safety of personnel such as signage, padding, highlighting or additional lighting.

- > Where surfaces may become wet, a provision is to be made to prevent the retention of liquid.
- > Where a person could fall more than 6m from a step type ladder, it must be installed with side screen or a ladder cage.
- > Where it is necessary for a person to step sideways from a ladder, the ladder stiles and rings must extend 1000mm above the top landing. The horizontal distance from the stile to the landing must be no greater than 175mm. The foot of the ladder must rest on, or terminate above, the landing.

The requirements of the building code may also apply where there is an enclosing structure such as a crusher house.

For more detailed information on access systems, including detailed diagrams of dimensions and construction, maintenance and test requirements see AS 1657 *Fixed platforms, walkways, stairways and ladders – Design, construction and installation* for more information.

12.8 GUARDING

The WHSR requires guarding to be designed to prevent access to the danger points or danger areas of plant or structures. If the plant to be guarded contains moving parts and those parts may break or cause workpieces to be ejected, the guarding will control any risk from those broken or ejected parts. Guarding used is to be of solid construction and securely mounted to resist impact of shock. If the guarding can be removed for maintenance or cleaning, the plant cannot restart unless guarding is replaced so far as reasonably practical.

Heat or cold is guarded or insulated so the plant is without risk to health and safety of any person.

SafeWork NSW also has a code of practice *Managing the risks of plant in the workplace* which provides guidance on guarding. Australian Standard series 4024, in particular AS/NZS 4024:1601, 1602 and 1603 cover guarding of machines.

Where elimination of a hazard is not practicable, guarding is an effective isolation and engineered control, provided the guards are compliant with Standards. For the guards to stay effective, they must be in place while the equipment is in an un-isolated condition.

Guarding on fixed and mobile processing plant typically found in quarries and mines is required to prevent injury to workers from moving and dangerous parts. The following examples are not a comprehensive list and you will need to assess what type of guarding is needed to suit the circumstances at your site.

Perimeter fencing (or area guards) do not meet the minimum requirements of AS/NZS 4024 Series, where workers require access within the perimeter while the machinery is running.

In these situations, close-fitting fixed guards should be used to guard individual nip points and entanglement hazards.

Examples of fixed guards include:

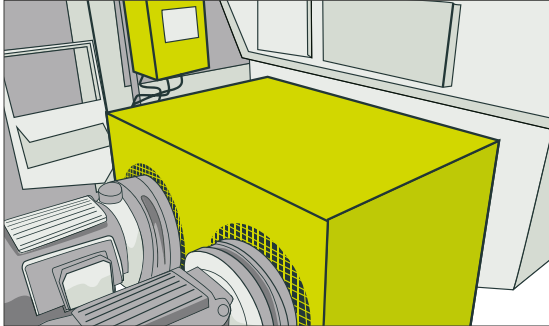

Figure 66. Example of fixed close-fitted guard enclosure on direct drive electric motors

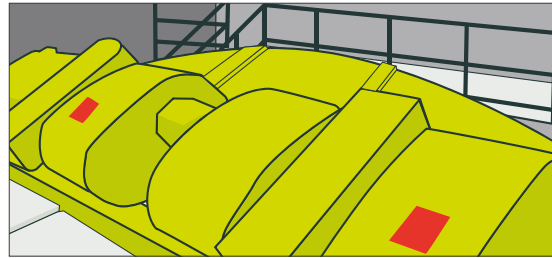

Figure 67. Example of totally enclosing sheet metal guard which are suitable for vibrating units with additional guards over the associated shafts and couplings

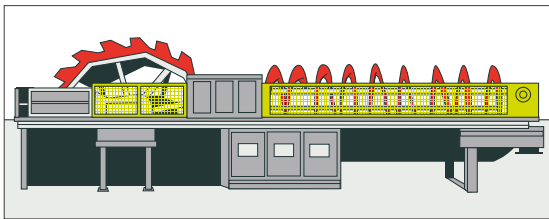

Figure 68. Example of panel mesh guards on fines dewaterer

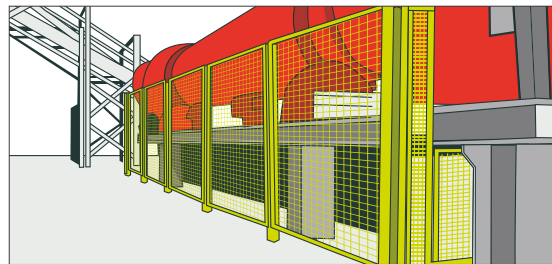

Figure 69. Example of panel type guards on dryer

Mines de-waterers use slowly rotating scraper blades to extract the finer particles. In addition to a sheet metal guard on the main dewatering section, a mesh guard should be provided around the trough of the scraper blade section. This should be fitted high enough to avoid workers falling into the trough or being able to reach the scraper blades and protect up to 2.7 metres above ground level.

Panel type guards secured to fixed uprights may be suitable for large rotating cylinders such as screens, dryers and trommels. The minimum height of the guard should be 2700 mm and a maximum of 180 mm from the ground. Access gates should be interlocked unless access is required less than once per shift, in which case a locked gate can be used (must require a tool to open).

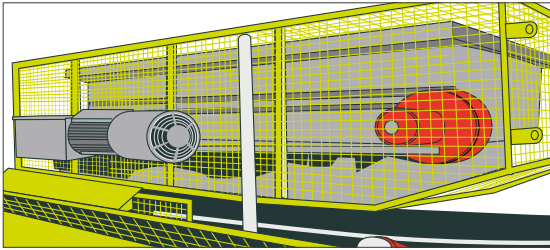

Figure 70. Example of close fitted guards on batch feeder belts

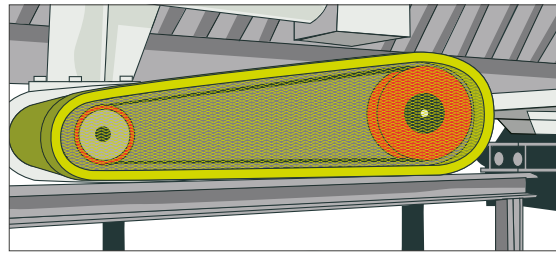

Figure 71. Example of close fitted guards on vee-belt drive

Batch feeder belts (while generally slower) have the same hazards as a normal conveyor. The feeder and all associated nip points should be enclosed within suitable guards fitted along the full length of the feeder. Guards should be provided on the underside to prevent access to tail and head drums and return idlers.

Vee-belt drives are commonly used on various items of plant. Open mesh guards help with efficient cooling of the vee-belts and pulleys and allow vee-belt tension to be visually checked without removing the guard. A mesh aperture size should be selected in accordance with the clearance distance to the hazard point (refer AS/NZS 4024 Series).

The guard should fully enclose the front and back to prevent access.

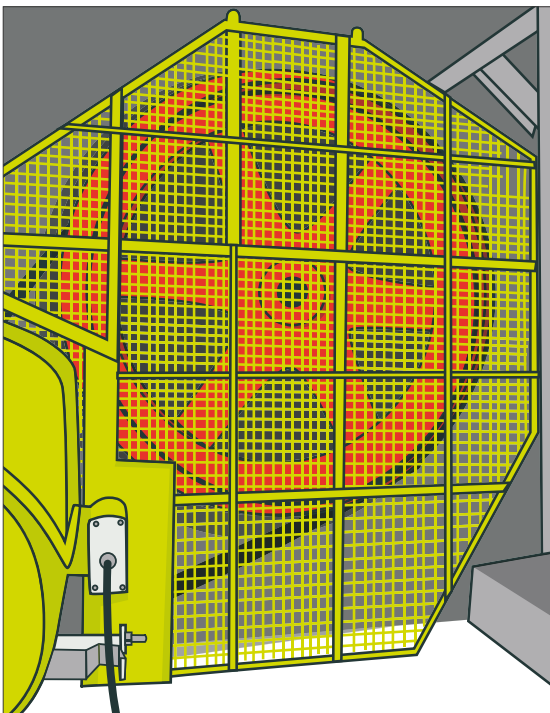

Figure 72. As with vee belt drives, a fixed guard totally enclosing the drive is suitable for primary jaw crusher drives. Alternatively guarding fitted around existing structures may be suitable

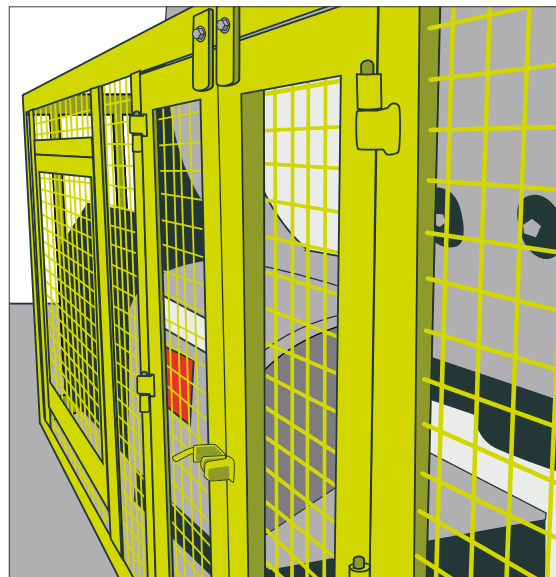

Figure 73. Example of hinged access panel guard bolted shut

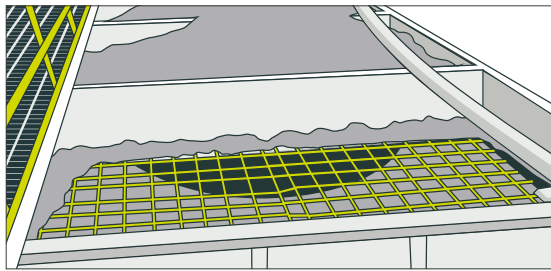

Figure 74. Example of steel man-grid on elevated feed hopper

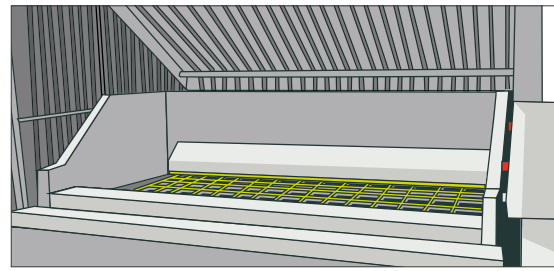

Figure 75. Example of steel man-grid on ground feed hopper

Steel grids with sufficient strength to withstand any anticipated loads should be provided in the top of all ground feed hoppers and easily accessible elevated feed hoppers. This is to prevent unauthorised or inadvertent entry. The exception is with primary hoppers or where products of a large dimension are being processed that may obstruct or otherwise damage the grid. Fitting grids on elevated hoppers may encourage people to walk on them next to an unprotected edge. Appropriate access prevention measures should be incorporated in the design (e.g. barriers, notices).

Provision should be made to enable drivers at ground feed hoppers to release tail gate latches from a position of safety.

Where a hazard exists from material falling from above, suitable guarding or hard barrier exclusion zones should be installed to manage the risk.

12.8.1 CONVEYOR GUARDING

Many serious incidents and fatalities with conveyors result from the machinery and associated in-running nip-points and shear-points not being adequately guarded. Reference should be made to the AS/NZS 4024.36 Series of conveyor safety standards for clear guidance on guarding requirements.

A wide variety of mechanical motions and actions on a conveyor system will present hazards to the worker. These can include the movement of rotating parts, moving belts, meshing gears and any parts that may draw-in, impact or shear. These different types of hazardous mechanical motions and actions are intrinsic in varying combinations to nearly all machines and recognising them is the first step toward protecting workers from the hazards they present.

On a conveyor, in-running nip points are dangerous trapping points at the line of contact between the rotating drum or pulley (cylinders) and the moving conveyor belt on the in-running side of the cylinder. A similar point on the out-running side of the cylinder where the conveyor belt exits may not be as dangerous a location - unless the conveyor can be reversed.

Even smooth, slowly rotating cylinders can grip clothing and through skin contact alone force an arm, hand or body into a dangerous position. Frequently the machine is running too fast or is too powerful to allow the person to stop the machine or pull the body part out – even if all of the lanyard and E-stop equipment is correctly installed and functional. This can result in severe friction burns, amputation or significant (including fatal) crushing injuries. Where a moving part cannot be eliminated and workers are exposed to potential contact, fitting fixed barrier guards and additional in-running nip guards are practicable isolation controls.



Hazardous trap points may occur at the following locations:

- > power transmission moving parts
- > head and tail end pulleys
- > bend, snub and take-up pulleys
- > carrying and return idlers beneath feed
- > hoppers, skirt plates and where the free lift of the belt has been restricted, as well as at convex curves (brow position)
- > roller assemblies for conveyor belt tracking
- > idlers accessible to people such as from crossovers or underpasses, maintenance or storage areas or cleaning areas and transition idlers adjacent to pulleys
- > drive pulleys (head-drums).

The following outlines possible guarding for conveyor belt parts in operation including:

- > power transmission moving parts
- > belting
- > upper and lower strands in a straight run
- > curved zone (brow positions)
- > head and tail drums and transition zones
- > gravity take up units
- > fixed obstacles
- > skirt boards.

It also provides general information on using nip guards.

POWER TRANSMISSION MOVING PARTS

Hazards associated with power transmission moving parts include the drive shaft, shaft end, sprocket, pulley, chain, drive belt and gear coupling. Possible consequences include drawing-in and crushing and entanglement of a loose piece of clothing in a protruding moving part.

If a hazard is less than 2700 mm from the ground or working platform, fixed barrier guards (of the appropriate reach distance) must be fitted.

BELTING

If the belting is in good condition, possible consequences of contact (depending on the speed and belt characteristics) include friction burns or abrasion and impact with the belt. Install hazard controls in accordance with the risk assessment results.

If the belt is not in good condition or there is evidence of a damaged belt splice, drawing-in, burns and lacerations may be more likely. Change the belt splice design or manufacturer if this is an ongoing problem. Otherwise maintain the belt and belt splice according to the manufacturer's specifications.

CARRY SIDE AND RETURN SIDE IN A STRAIGHT RUN OF A BELT

An in-running nip-point will be present between:

- > the carry side of belt and the pulleys under the hopper
- > the carry side of belt and the pulleys under the skirt-board or skirt
- > the carry side of belt and support rollers
- > the return side of belt and return rollers
- > the return side of belt and scrapers.

The following diagrams show suggested guarding in these areas.

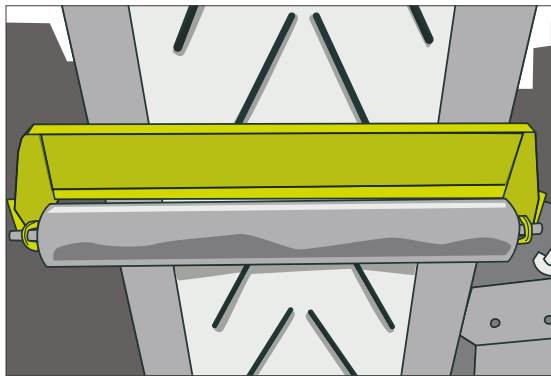

Figure 76. Plate type guard

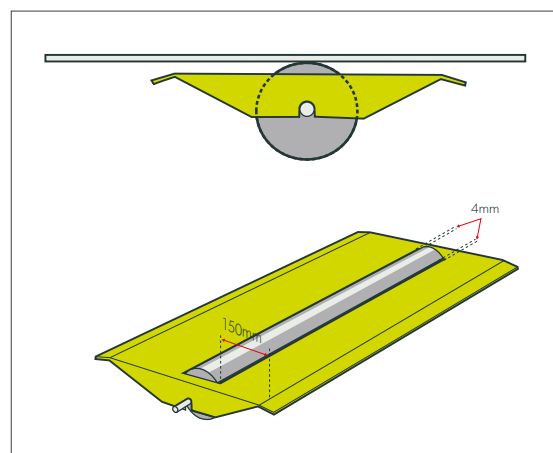

Figure 77. Bottom idler nip guard

CURVED ZONE (BROW POSITIONS)

In-running nip-points will be present between the belt and rollers in the convex curved zone with a possible drawing-in consequence. Fit a fixed barrier guard and, where required, additional nip-point guards.

HEAD AND TAIL PULLEYS AND TRANSITION ZONE

In-running nips with a possible drawing-in hazard are present:

- > between the belt and pulley drums
- > at the junction between two conveyors
- > between the pulley drum and fixed support brackets
- > between the upper strand and the load carrying rollers in the transition zone.

Entanglement hazards also exist where the shaft is exposed. A fixed barrier guard and additional nip-point guards should be fitted.

Head pulley drums, and return idlers which may become accessible by climbing stockpiles should be guarded. Alternatively stockpile heights should be strictly maintained to below 2700 mm in accordance with AS/NZS 4024.1 and AS/NZS 4024.36 Series reach distances.

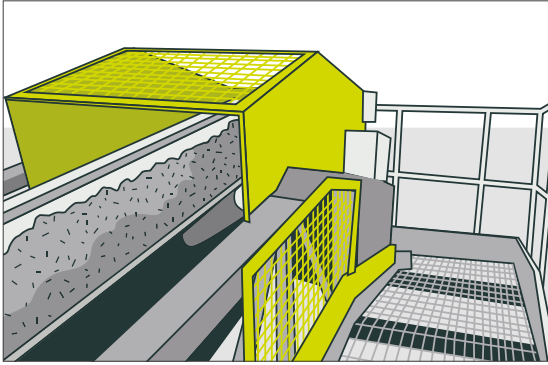

Figure 78. Example of head drum guards

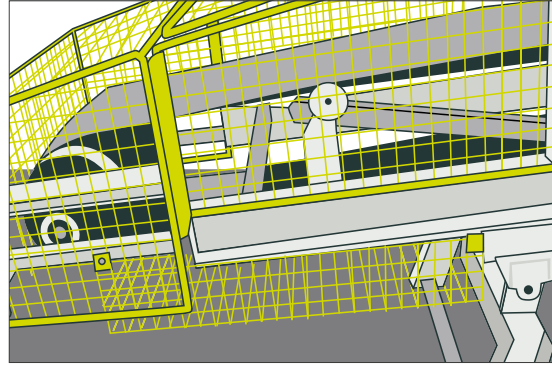

Figure 79. Example of tail drum guard

GRAVITY TAKE-UP UNITS

Conveyor gravity take-up units should be enclosed with mesh panels that prevent access to moving parts within the structure.

This prevents the risk of the gravity take-up weight falling to ground level in the event of the belt, chains or ropes breaking. All panels should be secured so they require a tool for removal or be interlocked.

Guard panels should extend to ground level – according to the clearance distances specified in AS/NZS 4024.3610.

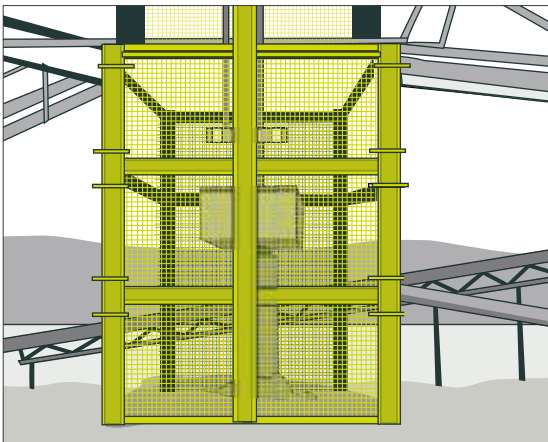

Figure 80. Example of perimeter guarding on gravity take-up points

FIXED OBSTACLES

Fixed obstacles that are not part of the conveyor can result in a person being trapped between the load/moving part and the fixed object. Examples of fixed objects are:

- > posts
- > walls
- > tunnel entrances
- > associated fixed equipment (i.e. metal detectors)
- > large bulk loads (i.e. boulders).

In accordance with risk assessment results, consider fixed guards and deterrent devices.

The objective is to keep the body, arms and legs away from the crushing area. The type of guard and its dimensions will depend on the body part at risk of being trapped and the weight of the load. The guard itself must not create a drawing-in or entrapment area.

SKIRT BOARDS

Ensure conveyors are designed, installed and used in such a way that no-one is hit by falling objects. The use of skirt boards can limit the amount of material that falls from conveyors (refer to Figure 81).

Install skirt boards or other protective devices at:

- > loading and transfer areas. It is recommended that the skirt boards be at least two and a half times longer than the belt is wide to allow the material to stabilise on the belt after transfer
- > areas that have unusual features, such as magnets, crushers and grizzlies
- > places where people pass under the belt
- > areas where maintenance, clean-up or inspection activities are frequently performed.

In situations where fixed skirts are fitted above conveyor idlers, a nip-point exists between the idler and the belt. Panels of guards should be fitted to prevent access to these points associated with the skirted sections of the conveyor (refer to Figure 82).

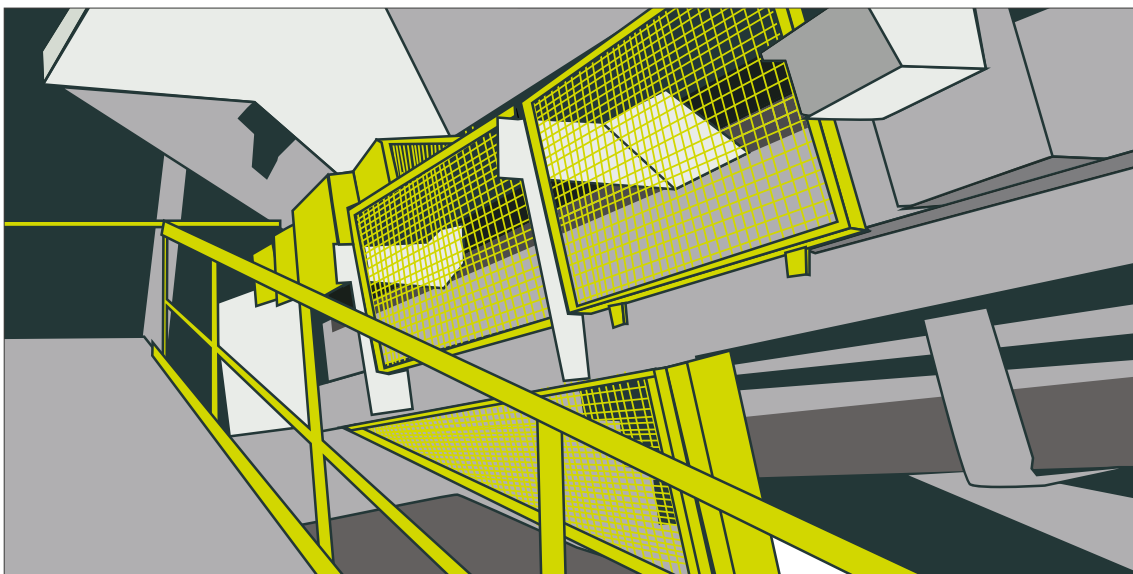

Figure 81. Example of skirting guards

GENERAL INFORMATION ON THE USE OF NIP GUARDS

Nip guards prevent access to the in-running nip's drawing-in zone. Where practicable, the nip guards should fill the drawing-in zone as much as possible and should be sufficiently rigid not to increase the clearance between the guard and the cylinders or the belt.



However, nip guards do not protect against the risk of pinching between the guard and the cylinder or belt and residual risks of abrasion or burns may remain. In addition, they do not provide appropriate protection against the risks of hair or clothing being drawn in. Therefore, the risk assessment should consider that the drawing-in effect increases with the diameter of the rollers, their roughness, their rotational velocity and the clothing or PPE worn (e.g. gloves).

To limit the risks of pinching, abrasion and burns, the clearance between the nip guard and the cylinder or belt should be as small as possible (maximum 5 mm). The angle between the guard and the tangent to the cylinder or between the guard and the belt should be 90° or slightly larger.

Nip guards are particularly suitable for cylinders, pulley drums and rollers with a smooth and full end disc. They can be used with a smooth, flat or troughed belt if they follow the profile of the belt and the belt is tight and does not vibrate.

Where there are other machine hazards that require guarding (e.g. head drums with exposed rotating shafts), nip guards should be used in addition to fixed or inter-locked barrier guards.

IDLER ROLLER NIP HAZARDS ON HEAVY DUTY BELT CONVEYORS

There is a significant risk of injury posed by nip-point force on heavy-duty conveyor top and bottom idler rollers and the increased accessibility of nip-points due to greater width of idler rollers (particularly bottom idler rollers).

The four main factors to consider when undertaking a risk assessment are:

- > **Likelihood of access to the nip-point:** Determined by the height of the nip in relation to the activities that could be performed at that location and the separating distance between the nip-point and the likely position of workers that might make contact with it. Australian Standards require guarding up to a height of 2700 mm from the ground or other structure that someone may be standing on.
- > **Degree of harm that might result:** Determined largely by the pressure between the belt and the idler roller. For example, if the stationary conveyor belt cannot be lifted off the idler by a person using one hand, it is likely nip guards will need to be installed.
- > What a person concerned knows, or ought to know about the hazard or risk and ways of eliminating or minimising the risk.
- > The availability and suitability of ways to eliminate or minimise the risk.

ADDITIONAL IN-RUNNING NIP GUARDS

Occasionally access is required behind barrier guards or fixed guards for maintenance, adjusting and cleaning of conveyor systems.

This results in potential exposure of workers to unprotected nip points. In addition, guards are often left off for routine tasks.

Mandatory procedures for the isolation of conveyors before guards are removed is one control method. In the hierarchy of controls, this is an administrative control. Additional engineered controls could include emergency stop cables interlinked with the guards so that if the guards are removed, the conveyor stops. These are not as effective as fitting nip guards directly at nip-points.

MAINTAINING NIP GUARDS

Nip guards are essential safety devices and they must be maintained in effective working order. They should be subjected to a suitable scheme of inspection, examination and maintenance. It may be helpful to identify each nip guard individually in inspection and maintenance check lists to make it easier to inspect and maintain them.

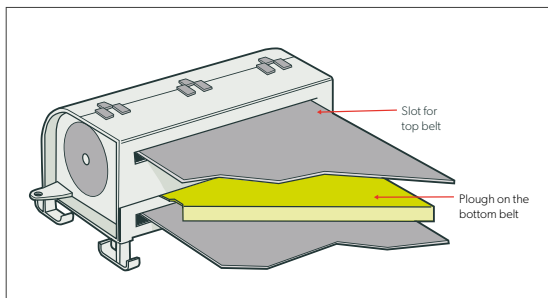

Figure 82. Tail drum return nip guard

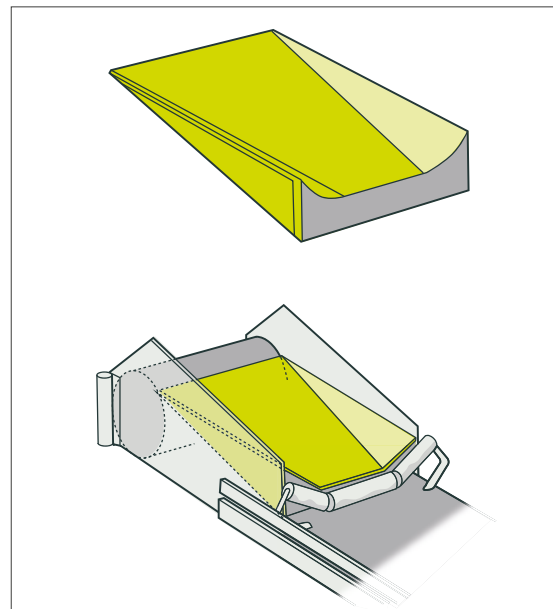

Figure 83. Head drum nip guard

12.8.2 STONE GUILLOTINE GUARDING

Stone guillotines (or stone cutters) with unguarded cutting knives or blades can cause amputations and other serious injuries.

Examples of machine guarding methods include barrier guards, two-handed (dead-man) starting devices, remote-operator controls and electronic safety devices (e.g. light curtains).

Using machine-guarding methods that eliminate worker access to the cutting knife (called the “point of operation”) is the preferred method of hazard control (refer to Figure 84).

Two-handed starting devices are a cycle-initiation method that requires constant, simultaneous pressure from each hand on two separate controls to move the cutting knife. If the operator removes either hand from either of the controls, the blades will stop immediately. Two-handed starting devices are essential where fixed guards are not practicable (e.g. where the operator needs to feed blocks of stone into the cutting area) and operating controls are close to the knife.

A suitable guard should be fitted to the side of the guillotine opposite to the controls where workers may reach into the hazardous area. Guillotines that rely on someone picking or pushing the stone after being cut should be fitted with a drop side or conveyor. This is so the stone is fed away from the hazardous area. Alternatively, a suitable tool should be provided (refer to Figure 85).

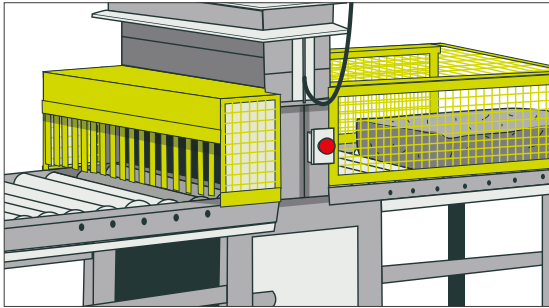

Figure 84. Stone guillotine with fixed guards

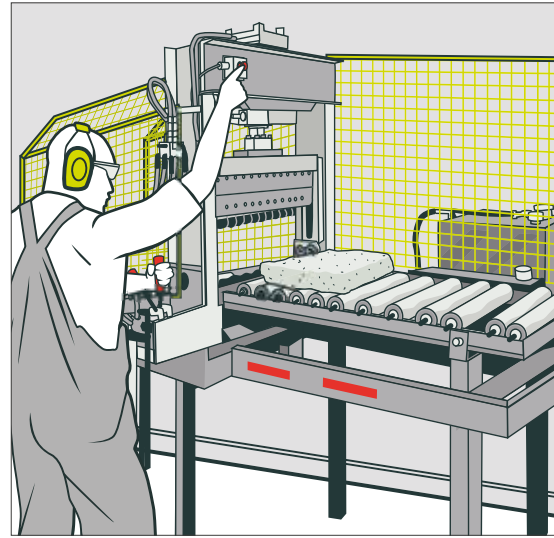

Figure 85. Example of two-handed starting device and drop side extraction

12.8.3 STONE SAW GUARDING

Stone saws range from automated, sophisticated equipment capable of cutting large slabs of stone and intricate designs to smaller machines capable of simple cuts. Regardless of the size of the saw, an operator may be in close proximity to the hazardous area when operating and suitable guarding or controls should be in place.

For larger saws, the use of perimeter fences and interlocked gates would prevent inadvertent access and the operator from working in close proximity to the equipment. Fixed guards alone might not be feasible as access is required for loading and unloading the stone. The following would all offer a high standard of protection:

- > A perimeter fence and interlocked guards, such as manually actuated sliding access gates (refer Figure 86). The interlocked guards should be fitted with a locking device so the guard remains closed and locked until any risk of injury from the hazardous machine has passed. This should allow for the rundown time of the saw blade.
- > Electro-sensitive protective equipment such as light curtains at the front of the enclosure. When used in conjunction with a braking system to stop the movement before access to dangerous parts occurs. Alternatively, the saw head could immediately return to a home position with a local guarding enclosure (refer Figure 87).
- > Local retracting guards around the circular saw blade and pressure sensitive edges on the saw head and traversing table. This would have to be in conjunction with fast stopping times of the head and saw blade. Care must be taken when fast stopping a fast spinning blade as the risk of breaking off the cutting pieces may create a hazard of flying material.

Guards, in some circumstances, may be constructed and extended to also serve as noise enclosures. Local exhaust ventilation systems may be integral with the guard where appropriate.

Fixed guards or two-handed operator controls such as those outlined for stone guillotines may be suitable for smaller saws.

Remote-operator controls force the operator to remain at a safe distance from the hazard point (refer Figure 89). Hold-to-run (or dead-man) controls should be used for remote operator controls. The machine should run down in the time it would take someone to reach the hazardous area when the operator removes their finger or hand from the control. Suitable controls must be in place to stop anyone else entering the hazardous area.

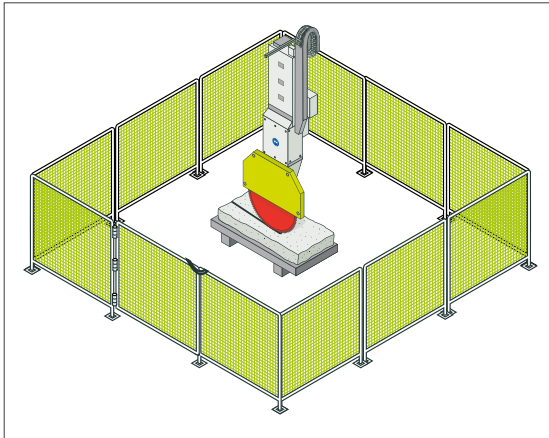

Figure 86. Stone saw with gate at access points

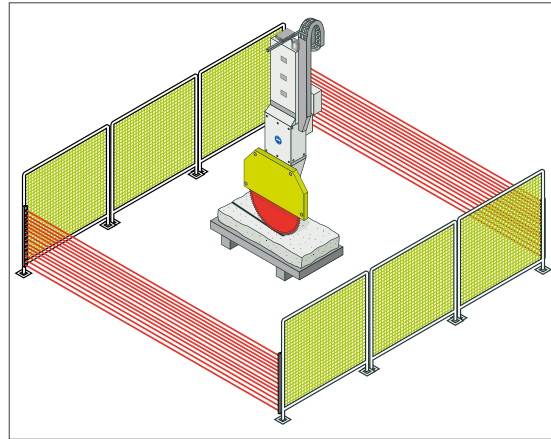

Figure 87. Stone saw with light curtains at access points

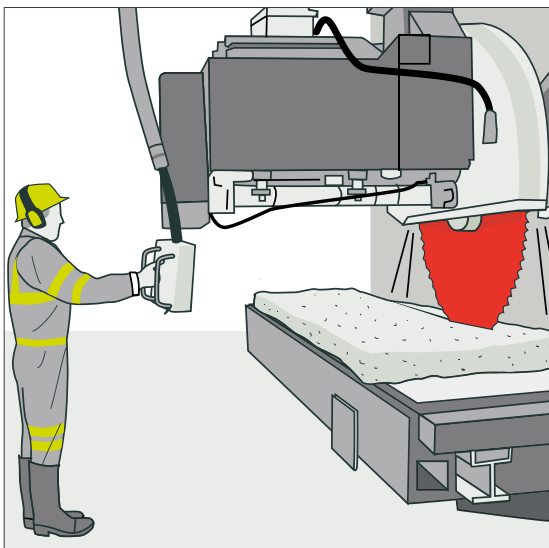

Figure 88. Remote operation controls on stone saw

12.8.4 GUARDING AND MAINTENANCE

Where maintenance requires normal guarding to be removed, additional measures will be needed to prevent danger from the mechanical, electrical and other hazards that may be exposed. This is also necessary if access is required inside existing guards. If guarding is removed, the plant cannot be restarted unless the guarding is replaced.

(5) Despite anything to the contrary in this clause, the person with management or control of the plant must ensure:

- (a) that the guarding is of a kind that can be removed to allow maintenance and cleaning of the plant at any time that the plant is not in normal operation, and
- (b) if guarding is removed, that, so far as is reasonably practicable, the plant cannot be restarted unless the guarding is replaced.

There should be clear rules on what isolation procedures are required, and in what circumstances (e.g. some cleaning of mixing machinery may require isolation, even though it might not be considered a maintenance task).

Tensioning, tracking, lubrication and other maintenance is usually done while equipment is running. To eliminate the risk of injury, adjusting rods and nuts should protrude out beyond the guards, but not create a further snagging or tripping hazard. Consider grouping the lubrication points for access outside the guards (refer Figure 89), otherwise known as a manifold point.

Consider manual handling when removing guards for maintenance to be carried out. Lifting attachments on guards may be required.

For more detailed information on maintenance and repairs, including isolation and tag out, see section 17.

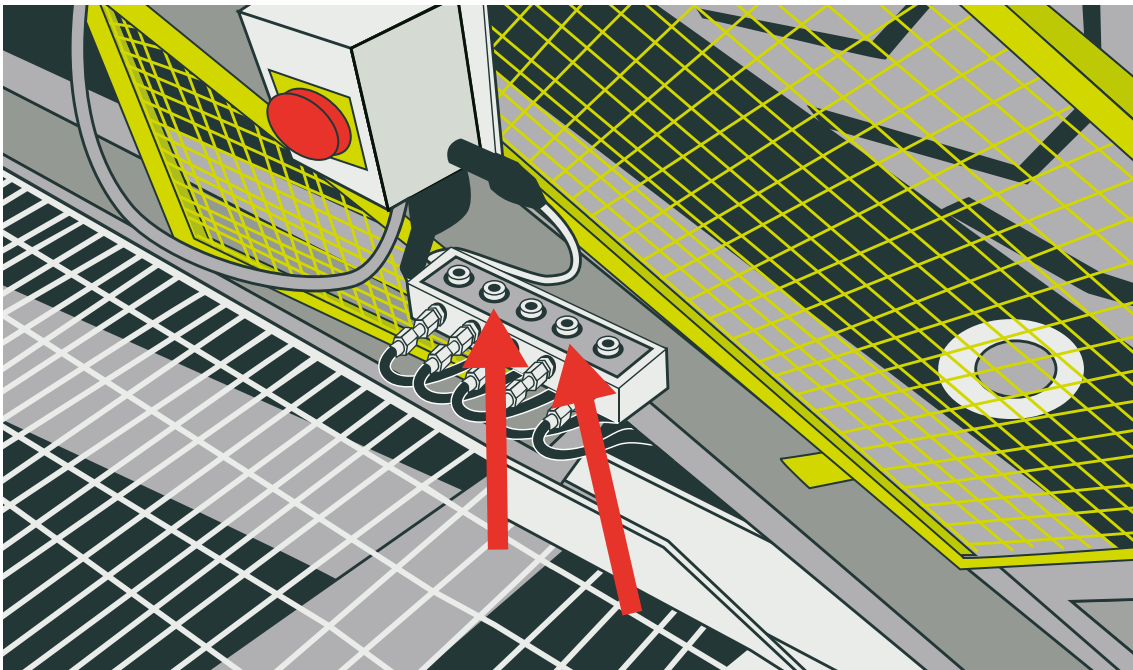

Figure 89. Example of remote greasing points

12.9 CONVEYORS

There are many risks associated with the operation of conveyors. The WHSMPS Regulation imposes specific control measures in clause 44A as set out below.

- (1) In complying with clause 9, the mine operator of a mine must manage risks to health and safety associated with the operation of belt conveyors at the mine.
- (2) In managing risks to health and safety associated with the operation of belt conveyors at the mine, the mine operator must:
 - (a) ensure that all belt conveyors are fitted with an emergency stop system
 - (b) have regard to all matters relevant to risks associated with the operation of belt conveyors
 - (c) ensure that belt conveyors are regularly inspected by a competent person
 (Clause 44A WHSMPS Regulation)

The mechanical plant and structure risks associated with conveyors must be managed through the mechanical engineering control plan. Schedule 2 of the WHSMPS Regulation identifies five matters set out below that must be considered when developing a control measure in respect of a belt conveyor for the plan.

The electrical risks on conveyors will be managed via the electrical engineering control plan. There will be an interaction between the two plans because there are both mechanical and electrical hazards associated with conveyor systems at a mine.

Schedule 2(4)(2) identifies the following when considering control measures for risks from mechanical hazards on conveyor belts.

- (a) the risks associated with belt conveyors,
- (b) the protection of persons near or travelling under a belt conveyor against the risk of being struck by falling objects
- (c) in the case of a belt conveyor at an underground coal mine or in a reclaim tunnel—Australian Standard AS 4606-2012, Grade S fire resistant and antistatic requirements for conveyor belting and conveyor accessories
- (d) risks arising from the starting of belt conveyors
- (e) the interaction of persons and belt conveyors including provision for the safe crossing of belt conveyors by persons.

(extract from Schedule 2, clause 2(4) WHSMPS Regulation)

12.9.1 ANTI-RUN BACK DEVICE AND CONTROLLED BRAKING ON CONVEYORS

Any inclined conveyor has the potential to either run back (where the direction of the material is up) or run-away (where the direction of the material is down). These situations can be prevented by installing an anti-run back device (or sprag clutch) and controlled braking systems.

For more detailed information on anti-run back devices and controlled braking systems see AS/NZS 4024:3610 *Safety of Machinery – Conveyors – General Requirements*; or AS/NZS 4024:3611 *Safety of Machinery – Conveyors – Belt Conveyors for Bulk Materials Handling*.

12.9.2 CONVEYOR CROSSOVERS AND UNDERPASSES

As well as the guarding requirements outlined in section 12.8, you should provide safe crossing points where a conveyor may need to be crossed routinely by workers.

Crossing over or under conveyors should be prohibited except where safe passageways are provided.

Belt conveyor underpasses (as defined by AS/NZS 4024:3611) must have a minimum of 2 m clearance overhead and be 600 mm wide. The top part must be guarded to prevent contact with the belt and to prevent material falling onto the worker. Barriers or guards should be fitted so that access to the belt up to 2.7 m is prevented either side of the underpass (see figure 90).

Whenever conveyors pass adjacent to or over work areas, roadways or other passageways, protective guards should be installed. The guards should be designed to catch and hold any load or material that may fall off or become dislodged from the conveyor (for more information on conveyor skirt boards see 12.8.1).

Where conveyors are operated in tunnels, pits and similar enclosures, ample room should be provided to allow safe access and operating space for all workers.

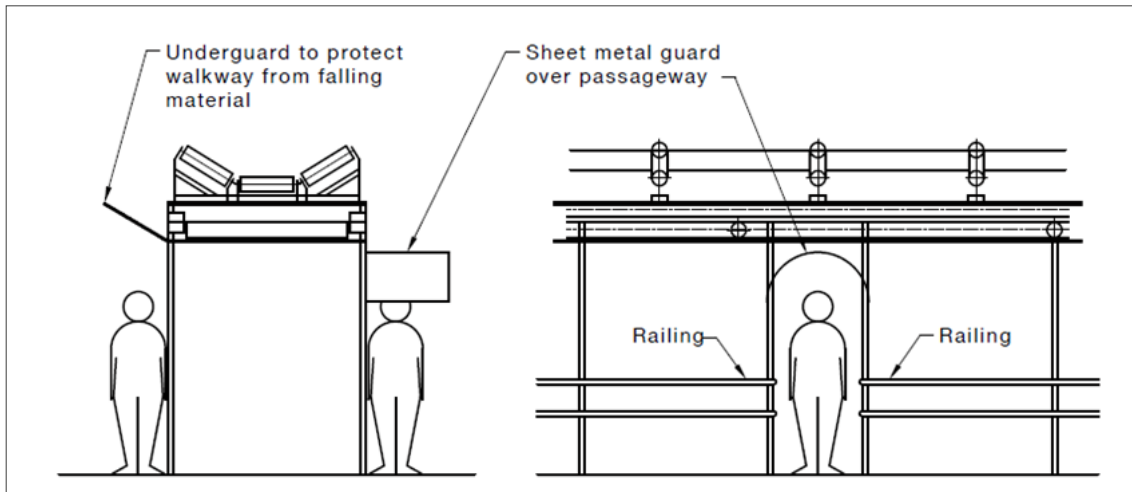

Figure 90. Example of a conveyor underpass

12.9.3 PRE-START WARNINGS ON CONVEYOR BELTS

Pre-start warnings should be provided on conveyor belts to alert workers that the conveyor is about to start and that they could be in the vicinity of a potential hazard.

On overland conveyor systems, the devices should be placed at the transfer, loading and discharge points and those points where workers are normally stationed. Warning signs stating 'conveyor may start without warning' should be strategically placed along overland conveyors where it is reasonably foreseeable that workers may be near the conveyor.

For more information on pre-start warning systems see section 12.11.

12.9.4 RECLAIM TUNNELS

The nature of reclaim tunnel operations is that the presence of people in the tunnel is required on an infrequent and irregular basis. Control room operators might not expect people to be in the reclaim tunnel on a regular basis which can lead to hazardous situations. Loading operations are remotely activated and a person is not required in the tunnel to operate it. Personnel should only enter the reclaim tunnel to inspect, clean or maintain the system.

Access to the reclaim tunnel could be hazardous to people in the following circumstances:

- > The person has not received instruction on the hazards and controls that have been developed to manage safety within the tunnel.
- > An unsafe condition has developed in the reclaim tunnel. (e.g. accumulation of gas, cessation of ventilation, outbreak of fire or similar, and the person is not aware of the condition.)
- > A person in the tunnel suffers an injury and other operators on the site are not aware.

TUNNEL BLOCKED IMPEDING MEANS OF EGRESS

Reclaim tunnels could become blocked so that egress is not available to people who may be within the tunnel. There could be a risk of harm to people through atmospheric contamination, flooding, fire, inundation of stockpile material or similar.

The means of tunnel blockage can include the following:

- > inflow of stockpile material through draw down points or entrances to the reclaim tunnel
- > flooding through rainfall and stockpile water inflows
- > conveyor malfunctions
- > gas explosion.

ATMOSPHERIC CONTAMINATION

Atmospheric contaminants (refer to National Standard for atmospheric contaminants) within the tunnel can become harmful to people through effects that could include the following:

- > Gaseous products from a stockpile material fire, spontaneous combustion or surface (bush) fire
- > Products of combustion from flammable materials within the tunnel
- > Ventilation flow blocked
- > Hazardous chemicals
- > Cutting and welding
- > Introducing mechanical apparatus to the tunnel
- > Atmospheric contaminants from diesel vehicles
- > High levels of airborne dust.

12.10 EMERGENCY STOPS

Emergency stops, including conveyor or other pull wire emergency stops (lanyards) are not substitute for guards. They are an additional control measure to ensure the safety of workers.

If plant is designed to be operated or attended by more than one person and more than one emergency stop control is fitted, the designer of the plant must ensure that the design provides for the multiple emergency stop controls to be of the “stop and lock-off” type so that the plant cannot be restarted after an emergency stop control has been used unless that emergency stop control is reset.

Mine operators must fit an emergency stop system that can be activated at any accessible point along the length of a conveyor belt (Clause 44A (2)(a) WHSMPS Regulation).

Emergency stop must not be used to lock-out the plant or equipment because the actuators can separate from the contacts and the stop button will fail.

Emergency stops should:

- > be red with yellow background where practical with signs for easy identification (refer figure 91)
- > be prominent as well as clearly and durably marked
- > be immediately accessible to each user of the plant or equipment
- > have red handles, bars, push buttons or pull cords (labels can also be used)
- > not be affected by electrical or electronic circuit failure.

For more detailed information on emergency stop controls see the *Managing risks of plant in the workplace code of practice* and AS/NZS 4024 *Safety of Machinery: Part 1604: Design of controls, interlocks and guarding – Emergency stop – Principles for design*, and AS/NZS 4024 *Safety of Machinery – Part 3610: Conveyors – General Requirements*.



Figure 91. Emergency stop with signage (photo courtesy of Fulton Hogan Miner Rd Quarry and NZ Steel Taharoa)

12.11 PRE-START WARNING SYSTEMS

Pre-start warning systems should be provided on machinery where sudden, unexpected operation could cause serious or fatal injuries to those who may be close to the machinery.

Because mines and quarry processing areas can be noisy and spread out, it will normally be appropriate to provide both visual and acoustic prestart warnings that work in conjunction with one another.

Acoustic signals should:

- > sound for long enough before the plant or equipment starts to provide adequate warning to anyone who may be in a position of risk
- > loud enough so they can be heard in the area they are providing a warning for
- > be at a level higher than the ambient noise without being excessive or painful, or causing environmental noise nuisance
- > be clearly different from any other warning signals or alarms.

Visual signals (e.g. flashing lights) should be placed so workers close to the plant or equipment will have the best opportunity to see it. Multiple visual signals could work, depending on the set-up of the plant and if an acoustic signal will be sufficient to provide warning.

Where visual signals are used, they should be of a suitable brightness and colour contrast to the background.

For more detailed information on acoustic and visual signals see AS/NZS 4024.1904: *Safety of machinery - Displays, controls, actuators and signals – Indication, marking and actuation – Requirements for visual, auditory and tactile signals.*

12.12 ELECTRICITY

There are many risks associated with electricity and it remains a source of fatalities and serious injuries. The WHSMPS Regulation imposes detailed specific control measures in clause 32 as set out below.

32 Electrical safety

- (1) In complying with clause 9, the operator of a mine or petroleum site must manage risks to health and safety associated with electricity at the mine or petroleum site.
- 2) In managing risks to health and safety associated with electricity at the mine or petroleum site, the operator must ensure:
 - (a) that electrical installation work at the surface is carried out in accordance with the Wiring Rules, and
 - (b) that before a circuit is first energised at the mine or petroleum site, or is first energised following the circuit being recommissioned:
 - (i) the circuit is tested in accordance with the Wiring Rules by a competent person, and
 - (ii) there is a process in place whereby the operator (or an individual nominated to exercise the statutory functions of electrical engineering manager or electrical engineer at the mine or petroleum site) can be adequately notified about that testing as soon as is reasonably practicable after the testing occurs, and
 - (c) that adequately rated switchgear is provided that permits power to be safely switched off and safely restored and that does not permit automatic restoration of power if there is a risk of electric shock, fire, explosion or unplanned operation of plant, and
 - (d) that arrangements are in place for switching the power off or restoring power as part of normal operations in the event of a fault or an emergency, and
 - (e) that, for electrical plant at the mine or petroleum site (other than plant connected, and in close proximity, to a wall socket with a switch):
 - (i) an isolation facility is provided, and
 - (ii) the electrical plant is clearly identified as being isolated from electricity by the facility, and
 - (iii) the facility is clearly identified as the isolator for the electrical plant, and
 - (iv) persons required to work with the electrical plant are competent in the correct use of the facility, and
 - (f) that plans of the electrical installations at the mine or petroleum site showing the following matters are kept and maintained as required and are easily accessible by each worker required to access them:
 - (i) the location of each main electricity reticulation line,
 - (ii) the location of all high voltage cables, aerials and switchgear,
 - (iii) the location, rating, identifying label and purpose of each main isolator, substation and high voltage switchboard,
 - (iv) any information required to perform switching programs,
 - (v) the location of all known buried electrical services at the mine or petroleum site,

- (vi) in the case of a mine or petroleum site (other than an underground mine), the general location of each item of high voltage mobile plant supplied with electricity by a trailing cable,
- (vii) in the case of an underground mine, the location of each fixed communication device at the mine, and
- (g) that arrangements are in place so that mobile electrical plant fed by a flexible reeling or trailing cable:
 - (i) is not connected to power if there is an earth fault in the cable, and
 - (ii) has its power interrupted automatically if the continuity of the connection to earth is interrupted, and
- (h) that arrangements are in place to ensure that mains-powered hand-held electrical equipment used at the mine or petroleum site operates at no more than 250 volts and has an earth leakage of not more than 30 milliamperes sensitivity, and
- (i) that an effective earth system is provided at the mine or petroleum site to minimise, so far as is reasonably practicable:
 - (i) touch, transfer and step potential, and
 - (ii) the effects of lightning causing the ignition of methane, the ignition of explosives or detonators or the creation of dangerous touch voltages, and
- (j) that all electrical installations (other than isolated circuits) have a continuous and effective connection to the earth system, and
- (k) that all isolated circuits comply with section 7.4 of the Wiring Rules, and
- (l) that the electricity supply to all electrical plant at an underground mine, and all mobile plant fed via flexible reeling or trailing cables in any other mine or petroleum site, is designed so that:
 - (i) the magnitude of earth fault currents to the plant is limited (in order to control step and touch potentials), and
 - (ii) so far as is reasonably practicable, the most likely type of electrical fault is a low energy earth fault (in order to minimise the amount of energy released), and
- (m) that the reliability of any electrical safeguards provided to control the risk from both electrical and non-electrical hazards is sufficient for the level of risk being controlled, and
- (n) that short circuit protection and over current protection is provided on all circuits (including sub-circuits), and
- (o) that, except for circuits that are isolated from earth, or that have a supply voltage that is extra-low voltage:
 - (i) earth leakage protection is provided on sub-circuits, and
 - (ii) earth fault protection is provided on all distribution and control circuits.

Most of these will apply to quarries, surface mines and dredges. These are forms of hazard controls and would be expected to be seen in the risk assessment for the use of electricity on the mine site and forms the basis for the electrical engineering control plan.

Further to the WHS legislation, the use of electricity is also governed by The Electricity (Consumer Safety) Regulation 2015. The Regulation:

- > sets out the generic rules and requirements about electrical safety, and what is deemed to be electrically safe and unsafe.
- > deals with the design, construction and use of works, installations, fittings and appliances.
- > provides for installations to be designed and installed under AS/NZS 3000 *the Wiring Rules*.
- > defines certification and documentation required for all electrical works.
- > provides for periodic assessment and verification of safety requirements specific requirements relating to Prescribed Electrical Work (PEW), design, maintenance and daily operations.
- > provides for offences including infringement offences.

It is important any electricians who perform electrical work are familiar with the AS/NZS 3000 *the Wiring Rules* and they certify all work they perform.

Another particularly important standard is AS/NZS 3007:2013 *Electrical equipment in mines and quarries – Surface installations and associated processing plant*. Make sure all electricians are familiar with this Standard.

The maintenance on mobile and relocatable equipment at alluvial mines and quarries should be determined by risk assessment. Equipment in highly corrosive environments (e.g. high salt) would be maintained on a higher frequency than those in low risk environments.

Machinery must be properly grounded before use and all connections, switches and cables must conform to AS/NZS 3000.

As a general rule:

- (a) Use residual current devices (RCDs) – correctly sized and rated for the application and level of protection required.
- (b) Electrical substations and switch rooms should be kept clean and not used as stores. They should be kept locked with access to authorised workers only. Where workers need to access substations or switch rooms they should be trained, authorised and all electrical enclosures should be rated at IP2X.
- (c) All equipment should be included as part of the electrical maintenance and inspection scheme.
- (d) Batteries should be treated with caution. Manufacturer’s instructions should be followed for maintenance and precautions to be taken (i.e. PPE).
- (e) Dust accumulations can have a serious effect on the safe functioning of electrical equipment. Make sure housekeeping procedures are in place.
- (f) All electrically powered equipment should be capable of being isolated. The isolation points should be clearly labelled and means of isolation provided (see section 17.2).
- (g) Where the workers have been properly trained it may be appropriate to access some electrical equipment for the purposes of resetting protective devices (e.g. circuit breakers). In these cases, the worker should follow clear procedures, opening the relevant cabinet doors and resetting the circuit breaker. The procedure should also provide guidance on what to do if the circuit breaker trips a second time. The board

should be designed and maintained so that inadvertent contact with live parts is not possible and the enclosure should contain any arc flash fault that may occur.

- h) Where wiring is damaged it should be reported immediately. Water should not be allowed to enter or accumulate in switch boards or switch rooms. All entry holes (e.g. cable gland holes) should be sealed to prevent dust and vermin from entering the switchboard.
- i) Underground cables and pipes should be accurately located on a site plan and identified before digging. Clause 32 of the WHSMPS Regulation and the wiring rules require detailed plans to be kept of buried services.

For more detailed information on safety around underground cables and pipes see *Dial before you dig* at www.1100.com.au, the *Excavation work code of practice* and the *NSW Construction work code of practice*.

12.12.1 FLEXIBLE CORDS (LEADS)

The WHS Regulation clause 150 requires flexible cords or leads used at the mine to be regularly inspected and tested and typically will have a tag issued in accordance with AS/NZS 3760 - *In-service safety inspection and testing of electrical equipment*. An assessment of risk for electric shock from flexible cords may result in carrying out inspections and testing more often.

A flexible cable or cord (for supply purposes) is one that has one end connected to a plug with pins designed to engage with a socket outlet and the other end either:

- > connected to terminals within the equipment
- > fitted with a connector designed to engage with an appliance power cord or fitting (e.g. socket).

Flexible cords are prone to damage because they are often outdoors in operational areas and can be subject to falling material, repetitive use, movement, vibration and extremes of weather. Regardless of the date of the tag, all flexible cords should be examined before being plugged in and used.

Consider any minor shock or tingle as a warning of a potential safety problem. If this occurs, immediately switch off the power and leave the cord as it is. It is a requirement of the WHSMPS Act that the scene is to be preserved. You are also required to immediately notify the Resources Regulator.



Figure 92. Flexible cords with tags

12.12.2 TRAILING CABLES

In addition to the requirements of WHSMPS Regulation clause 32 Electrical safety, safe systems of working with trailing cables should include complying with AS/NZS 3007 *Electrical equipment in mines and quarries – Surface installations and associated processing plant*.

These safe systems of working with trailing cables should also include:

- > regular inspections including in-situ visual inspection by machine operators and regular documented safety assessments
- > route criteria including support measures (where applicable), methods and heights for crossings, location of cables in proximity to roadways, protection measures required where it is necessary for vehicle crossings, etc
- > methods for relocation of cables and provision of adequate equipment to perform the task such as cable reelers or relocators
- > defined methods for manual handling and provision of adequate mechanical lifting aids to eliminate manual handling sprains and strains. Equipment to separate and join plugs should be used
- > regular inspection, maintenance and testing performed on substation earth systems including earth mats, earth impedance and earth connection points, protection relays and trip batteries
- > provision of unique clear identifiers for each cable and trailing cable plug and substation outlet
- > defined standards for the circumstances under which trailing cable protection relays can be reset and power re-energised onto a cable where the relay has indicated a fault to be present. This would include possible testing of the cable
- > developing, implementing, monitoring and reviewing systems of high voltage switching, access and authorisation (where applicable)
- > minimising direct handling of energised cables. Anyone required to directly handle energised trailing cables should wear insulating gloves covered by leather outer.

Training should be provided in the points above and in trailing cable hazard awareness for all people required to work with them. Workers associated with relevant tasks should be consulted in relation to the development of the systems and standards mentioned above.

12.12.3 MINE EARTHING SYSTEMS

The bonding to earth of electrical equipment is an essential control method to reduce or eliminate the risk of a person from suffering an electric shock. It relies on all exposed metal work on the equipment being bonded to the general body of earth using earth cables. This will result in the whole arrangement of equipment being at the same electrical potential as the general body of earth.

It is essential that the mine regularly check that the integrity of earthing system installed at the mine is in good condition. This is usually scheduled as an annual event and the statutory electrical tradesperson carries out tests on every electrical earthing circuit at the mine, verifying that the earthing conductors are in good condition.

Where mines have installed earth leakage protection devices (in addition to residual current devices (RCDs)) then these too form part of the protection network along with a good earthing system. The testing of the earth leakage devices and RCDs should be carried out on a regular basis to verify that they are working.

12.13 CRANES AND LIFTING EQUIPMENT

Where cranes are used on site, the WHS Act and WHS Regulation require that certain types of cranes and lifting equipment or plant be registered and also have the design registered. Items of plant requiring registration include:

- > tower cranes including self-erecting cranes
- > gantry cranes (over 5 tonne capacity) and bridge cranes (over 10 tonne capacity)
- > mobile cranes with a rated capacity of greater than 10 tonnes.

SafeWork Australia has published cranes guidance material that is a useful reference. This guidance provides information for PCBUs on how to manage the risks at a workplace associated with the inspection, maintenance and operation of cranes and other plant types, including quick hitches for earthmoving machinery.

It includes:

- > guidance on managing risks associated with cranes, including tower cranes and mobile cranes
- > information sheets on how to manage risks associated with several crane variants and attachments, including:
 - bridge and gantry cranes
 - powered mobile plant used as a crane
 - vessel mounted cranes
 - vehicle loading cranes
 - crane-lifted work boxes
 - an information sheet on quick hitches for earthmoving machinery.

Items of mobile plant, not originally designed as a crane but used for load-lifting incidental to their principal function, should be subject to the following conditions:

- (1) Lifting points and equipment used for rigging loads are to be certified by a registered professional engineer.
- (2) In the case of hydraulic excavators with an operating weight of 12 tonne or more the following additional conditions should apply:
 - (a) The equipment is not to be modified to make it operate as a crane other than the provision of a lifting point.
 - (b) Hose burst protection valves are required.
 - (c) Operators and ground support personnel are to be adequately trained.
 - (d) Operations are to be carried out in accordance with AS 2550 (Series) *Cranes – Safe Use*.
 - (e) The equipment is to have a loading chart available to operators.

All sites should develop a safe system of work for the use and management of all lifting equipment. This should include but is not limited to:

- > Every lifting appliance and item of loose gear shall be clearly and permanently marked with its working load limit (WLL) by stamping or, where this is impracticable or not recommended, by other suitable means.
- > Every lifting appliance and loose gear should have a unique identifying numbering system to clearly identify individual items.
- > All lift points to be certified by a competent person and clearly marked.
- > Visual inspection before and after use.

- > Examination by a competent person regularly depending on frequency, use and environmental conditions but not exceeding 12 months.
- > A register should be kept for lifting equipment. The register should show the date of the last recorded examination or test and any alterations or repairs.

12.14 PRESSURE VESSEL EQUIPMENT

If you have pressure vessels on site they must:

- > be regularly inspected by a competent person
- > have plant registration (selected types).

(Note: AS/NZS 3788 gives specific requirements for competency of in-service inspectors of pressure vessels.)

12.14.1 INSPECTIONS

The person inspecting the vessel should issue an inspection certificate for each inspection in accordance with the standard. Each certificate should match the stamping on the vessel. Sometimes the certificate will state any works that need to be done to maintain the safety of the pressure vessel. It is important that the mine then undertakes these works.

Mines will typically have unfired pressure vessels, such as air receivers on their compressors, accumulators on their trucks and LPG storage tanks.

The requirement to inspect compressed air pressure vessels for sizes under 150MPa.L (i.e. Pressure x Volume pV) is not stated. Neither is there criteria for accumulators under 200MPa.L. The standard does say that these smaller types are of a lower risk but they must be maintained in a fit and safe condition for service, including regular operating surveillance. It is recommended that when the larger pressure vessels are being inspected, the smaller vessels should also be inspected by the competent person.

The requirements for inspections under the standard are as set out below:

COMPONENT	TYPE OF INSPECTION	MAXIMUM INTERVAL BETWEEN INSPECTIONS
UNFIRED PRESSURE VESSELS		
Accumulators, Receivers	External	2 years
Receiver	Internal	4 Years
Accumulator	Internal	12 years
STATIC GAS STORAGE		
Non-corrosive including LPG	External	2 years
Non-corrosive including LPG	Internal	10 years

Table 10. Requirements for inspections

For other types of pressure vessels on site, a review by a competent person or pressure vessel inspector can assist in determining what inspections should be done and the frequency they occur.

If you have fired pressure vessels on site, seek professional advice as to the inspection regime for fired pressure vessels

12.14.2 REGISTRATION

Pressure equipment categorised as hazard level of A, B, C or D according to criteria in Section 2.1 of AS 4343 are required to be design registered. Pressure equipment categorised as hazard level of A, B, or C according to criteria in Section 2.1 of AS 4343 are required to be item registered (WHS Regulation).

An example of a vessel requiring registration is air compressors over 150MPL (MPa Litres). A pressure vessel inspector can assist in obtaining registration for vessels needing registration.

Australian Standards AS/NZS 3788 *Pressure equipment – in-service inspection*; and AS/NZS 4343 *Pressure equipment – Hazard levels* provide information on inspections and other matters associated with pressure vessels.

The code of practice *Managing the risks of plant in the workplace* provides further guidance on legislative requirements in relation to pressure vessels.

12.15 LIFECYCLE MANAGEMENT OF PLANT AND STRUCTURES

A key emphasis in the requirements for MECPs and EECPs is the lifecycle management of plant and structures. See below.

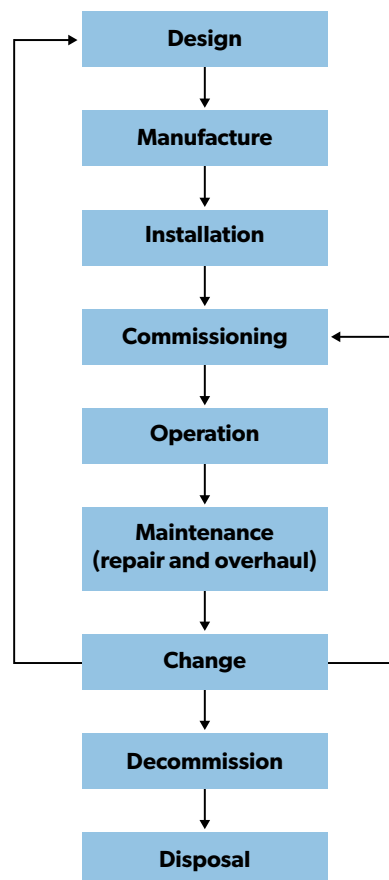

Figure 93. Lifecycle of plant and structures

The mechanical and electrical engineering control plan requires the lifecycle to be taken into consideration when developing control measures hazards.

For each phase of the lifecycle, determine how events that could cause injury to workers could occur and then, taking into consideration what control measures are needed, use the hierarchy of controls to eliminate or mitigate those events.

For each stage of the lifecycle different control measures will become apparent during the risk assessment. Some of these could be:

- > during the procurement phase, the design of the plant and equipment is the best time to build in engineering controls. For example, ensuring supporting structures and related plant items are not loaded beyond their design capacity (e.g. extending bins/hoppers, introducing materials of higher density, upgrading plant throughput rates, etc)
- > during the installation phase, good commissioning processes will ensure plant and equipment are installed correctly. It is also a good time to undertake inspections and testing to form baseline data, which can be checked over time to see if any plant or equipment is deteriorating
- > during the operations phase, implement structural adequacy and integrity of plant inspections (i.e. routine systems of regular inspection to monitor structural condition (e.g. corrosion, wear, fastener condition, etc))
- > when maintenance is carried out, implement systems to manage change, such as structural modifications (e.g. removal of bracing or cutting of penetrations). This change management process then controls all aspects of the design modification
- > ongoing maintenance during the operations phase should include processes to ensure the integrity of supports and foundations are not compromised (this includes structural elements that may be buried within stockpiles, etc), and that foundations are not undermined or adjacent ground conditions changed (e.g. by trenching or changing batter slopes).
- > during the decommissioning phase, it will be difficult to initially determine all hazards, however risks to people can be determined. When decommissioning is required, a full risk assessment can be done for that item of plant or equipment.

All of these arrangements must be tailored to the site operating conditions. For example, a wet processing plant (e.g. sand washing plant) operating in marine or saline conditions, may require much more frequent structural inspections (or audits) than a dry processing plant operating in a less corrosive environment.

13

PART **D**

Worker facilities

IN THIS SECTION:

13.1 Washing facilities

13.2 Toilets

13.3 Drinking water

13.4 First aid

13.5 Facilities for changing and storing clothes

13.6 Facilities for meals

13.7 Outdoor work

13.8 Remote or isolated work

You must ensure that workers are provided with adequate facilities including toilets, drinking water, washing and eating facilities. Suitable and sufficient numbers of facilities are needed to ensure the health and safety of everyone at the site. Facilities are those that are necessary for the well-being of your workers, such as washing, toilet, rest and changing facilities and somewhere clean to eat, drink and rest during breaks.

This chapter includes information from the SafeWork Australia *Managing the work environment and facilities code of practice*. See the code for more information.

Keep all facilities in a clean and sanitary condition. Facilities must comply with the *National Construction Code of Australia*, WHS Regulation clauses 40-41 and local authority bylaws as appropriate.

13.1 WASHING FACILITIES

Hand-washing facilities must be provided to enable workers to maintain good standards of personal hygiene. Workers may need to wash their hands at different times (e.g. after visiting the toilet, before and after eating meals, after handling chemicals or handling greasy machinery).

Where chemicals are being handled, mixed or applied, showers or suitable cleaning agents may be needed. Additional emergency showers may also be required (refer to the safety data sheet for the chemicals you are using).

Certain jobs may involve dirty, hot or hazardous work and may require the provision of showering facilities. At least one shower cubicle for every 10 workers who may need to shower should be provided.

Usually separate facilities should be provided for male and female workers. However, in small or temporary workplaces where privacy can be assured, it may be acceptable to provide one unisex shower.

13.2 TOILETS

Toilets must be provided in accordance with the *National Construction Code of Australia*.

Where it is not reasonably practicable to provide access to permanent toilets (e.g. short-term temporary workplaces and workplaces in remote areas), portable toilets should be provided. Portable toilets should be in a secure place with safe access. They should be installed so they do not fall over or become unstable and should be serviced regularly to keep them clean and functional.

13.3 DRINKING WATER

An adequate supply of clean drinking water must be provided free of charge for workers always. The supply of the drinking water should be:

- > positioned where it can be easily accessed by workers
- > close to where hot or strenuous work is being undertaken to reduce the likelihood of dehydration or heat stress
- > separate from toilet or washing facilities to avoid contamination of the drinking water.

The temperature of the drinking water should be at or below 24 degrees Celsius. This may be done by shading water pipes and storage containers from the sun or by refrigeration.

Do not use a common drinking container. Containers for drinking water should be kept clean and protected from contamination.

13.4 FIRST AID

The WHS Regulation places specific obligations on a person conducting a business or undertaking in relation to first aid, including requirements to:

- > provide first aid equipment
- > ensure each worker at the workplace has access to the equipment
- > ensure access to facilities for the administration of first aid
- > ensure that an adequate number of workers are trained to administer first aid at the workplace or that workers have access to an adequate number of other people who have been trained to administer first aid.

Applying a risk management approach to first aid involves the following four steps:

1. identifying the type of work being undertaken and identifying the hazards that could result in work-related injury or illness
2. assessing the type, severity and likelihood of injuries and illness
3. providing the appropriate first aid equipment, facilities and training
4. reviewing your first aid requirements on a regular basis or as circumstances change.

Workers at mines are exposed to significant hazards, particularly using or interacting with large plant and equipment. Many mines are also remote from easy access to emergency services so it is important that adequate first aid can be provided on site while waiting for services such as an ambulance to arrive.

Considerations for first aid are detailed in chapter 18 Emergency Management. Guidance on the provision of first aid facilities can be found in the SafeWork Australia *Code of Practice: First Aid in the Workplace*.

13.5 FACILITIES FOR CHANGING AND STORING CLOTHES

If workers have to change in and out of clothing due to the nature of their work, access to private changing areas with secure storage for personal belongings should be provided.

This includes workers who need to:

- > wear personal protective clothing or uniforms while they are working
- > leave their work clothing at the workplace.

If male and female workers need to change at the same time, separate male and female changing rooms should be provided. The changing room should allow a clear space of at least 0.5 m² for each worker.

13.6 FACILITIES FOR MEALS

Workers should be provided with access to hygienic dining facilities for eating meals and for preparing and storing food in reasonable comfort and sheltered from the weather.

A separate dining room should be provided if:

- > 10 or more workers usually eat at the workplace at the same time
- > there is a risk of substances or processes contaminating food.

Suitable rubbish disposal facilities should also be available.

Access to dining facilities for workers in remote areas, such as mining exploration workers, may be limited. At times the only enclosed facility available may be their vehicle. In this instance portable food storage facilities may be required, such as a car fridge or insulated lunch box.

13.7 OUTDOOR WORK

Outdoor workers should have access to shelter for eating meals and taking breaks and to protect them in adverse weather conditions.

Access to shelter should be provided, for example, using sheds, caravans, tents, windbreaks or portable shade canopies. In some situations, vehicles may provide appropriate short-term shelter.

Protection against solar ultraviolet (UV) exposure should also be provided for outdoor workers, for example:

- > reorganising outdoor work if possible so that workers carry out alternative tasks, or work in shade, when the sun is most intense (i.e. between 10 am and 2pm (11am and 3pm when there is daylight saving))
- > providing personal protective clothing (wide brim hat, long-sleeved collared shirt, long pants, sunglasses) and sunscreen.

13.8 REMOTE OR ISOLATED WORK

A person conducting a business or undertaking (PCBU) must manage the risks associated with remote or isolated work, including ensuring effective communication with the worker carrying out remote or isolated work.

Remote or isolated work is work that is isolated from the assistance of other people because of the location, time or nature of the work being done. Assistance from other people includes rescue, medical assistance and emergency services.

A worker may be far away from populated areas, for example:

- > a single worker or several workers at a remote mine
- > workers undertaking working at different parts of the mine.

In some situations, a worker may be alone for a short time. In other situations, the worker may be on their own for days or weeks in remote locations.

The length of time the person may be working alone should be considered when assessing the risks of remote or isolated work. Other factors to consider include:

- > what forms of communication are available
- > the location of the work (its remoteness)
- > the nature of the work (e.g. working with hazardous plant or electricity; exposure to dangerous animals including reptiles or insects or increased levels of fatigue)
- > the skills and capabilities of the worker (e.g. are they new to the work or experienced? Do they have any medical conditions?)

Control measures for remote or isolated work should consider the risks involved. Some jobs present such a high level of risk that workers should not work alone (e.g. jobs where work is carried out in confined spaces). In these situations, a buddy system should be used.

There are a range of options for communication systems including radio or satellite communication systems and distress beacons. Mobile phones cannot be relied upon as an effective means of communication in many locations. Establishing pre-set call-in times from areas with a mobile or landline service (e.g. at crib rooms or offices) can be a means of implementing control.

Movement records: knowing where workers are expected to be can assist in controlling the risks (e.g. call-in systems with supervisors or colleagues. Satellite (GPS) tracking systems or devices may also have the capability of sending messages as part of a scheduled call in system and have distress or alert functions.

Workers need training to prepare them for working alone and, where relevant, in remote locations. For example, training in dealing with potentially aggressive clients, using communications systems, administering first aid (including snake/insect bite), obtaining emergency assistance or driving off-road vehicles.



14

PART D

Site security and public safety

IN THIS SECTION:

14.1 Access to sites

14.2 Barriers

14.3 Signs

Consider ways in which working at the site may create a risk not only to workers but to the general public.

This section describes how to manage site access and other areas that may pose a danger to the public.

From a health and safety perspective, it is good practice to divert public rights of way around mines. It should be a part of the development process and mine planning to ensure public access only occurs in a controlled manner. These controls would be a part of the principal hazard management plan (PHMP) for roads or other vehicle operating areas.

14.1 ACCESS TO SITES

Access to sites should be controlled to make sure unauthorised people cannot go to a location where they may be at risk from site operations. This is particularly important for sites where there are sales to the public or in/near to residential areas. Control measures may include signs, automated barrier arms or worker controlled areas (e.g. a weighbridge operator) and security systems (cameras, patrols, trespasser detection systems). Records of people who enter and leave a site should be in place so that the mine knows at all times who is on the site.

14.2 BARRIERS

Providing and maintaining suitable barriers around the site to discourage trespass may be appropriate. Trespass means entry to the site without express or implied permission. Barriers are appropriate where it is reasonably foreseeable that members of the public, including children, are likely to trespass on the site and could suffer injury if they did so. The type of barrier required depends on the risks. In a rural area, where risk of public access is low, hedges, trenches and mounds may be enough. In areas where there is evidence of persistent trespass that places people at significant risk, substantial fences may be required.

Controlling unauthorised access by children and recreational users (e.g. trail-bikes and 4WDs) is particularly relevant for many extractive sites that are in close proximity to urban or residential areas. Long weekends and school holidays can add further challenge. On-going diligence and monitoring of the condition and effectiveness of controls is required and these items should be included on the routine site safety inspection checklists.

Workers should be encouraged to report cases of trespass or evidence that people have been on the site. They should also be told what action to take if they discover trespassers.

14.3 SIGNS

Suitable signs warning people of the possible hazards at the site should be erected at entry points and, where necessary, along boundaries (refer to Figure 94 and Figure 95). Any signs should be maintained in a legible condition. Regular site inspections (with documented checklists) should be scheduled to ensure site perimeter signage has not deteriorated or otherwise been damaged/removed (e.g. by vandalism).



Figure 94. Examples of signage warning of hazards



Figure 95. Example of sign at gate

15

PART D

Worker Health

IN THIS SECTION:

- 15.1 Health control plan**
- 15.2 Exposure monitoring**
- 15.3 Health monitoring**
- 15.4 Noise**
- 15.5 Vibration**
- 15.6 Atmospheric contaminants**
- 15.7 Working in extremes of temperature**
- 15.8 Hazardous manual tasks**
- 15.9 Hours of work and fatigue**
- 15.10 Mental health**
- 15.11 Ultraviolet radiation**
- 15.12 Contaminated land**
- 15.13 Hazardous chemicals**
- 15.14 Drugs and alcohol**
- 15.15 Personal protective equipment (PPE)**

Managing the health of workers is part of your WHS responsibility. Managing the health and wellbeing of your workers also pays dividends in terms of increased productivity, reduced sick leave, improved staff morale and loyalty.

This section describes how to:

- > identify and manage risks to workers' health
- > monitor workers' health by establishing exposure and health monitoring programs
- > protect workers from specific hazards including vibration, dust, fumes, ultraviolet radiation, thermal stress and chemical or biological hazards
- > manage risks associated with fatigue, drugs and alcohol
- > help workers handle the physical and mental pressures of working safely
- > provide appropriate personal protective equipment (PPE).

Ineffective workplace health hazard management is responsible for significantly higher levels of injury and death than workplace accidents. Within the context of occupational health, effective management is achieved by ensuring relevant health hazards are identified and, as a key objective, eliminated at their source. It is only appropriate to control health hazards by reducing the likelihood of harm when elimination is not reasonably practicable. Personal protective equipment (PPE) is the lowest form of control and should be a last resort.

For controls to be effective, managers, workers and their representatives should:

- > have easily accessible information on the nature of a health hazard and how it can be controlled and monitored. This information must be updated as knowledge on new health hazards becomes known and new techniques for managing them are developed
- > have the necessary capability (both through access to equipment and technology and the managerial skills) to make sure good systems are in place
- > be motivated to take action to control exposures to health hazards and reduce risk.

You can find a range of information on the Resources Regulator website on the health management page.

15.1 HEALTH CONTROL PLAN

The mine operator must prepare a health control plan for the mine. It must set out how the operator will manage the risks to health associated with the mining operations undertaken at the mine.

A health control plan for a mine must address the following:

- (a) the control measures for eliminating or minimising the exposure of workers to health hazards such as dust, noise, hazardous substances, contaminants (airborne or otherwise), ultraviolet and ionising radiation and vibration
- (b) the control measures to ensure that people working at the mine site are fit to carry out that work without causing a risk to their own or others' safety, including the control measures for minimising the risk that a worker will be impaired by fatigue, extremes of temperature, moisture content of air or intoxication by alcohol or drugs



- (c) monitoring of the existence of the health hazards at the mine and the exposure of workers to those hazards
- (d) the arrangements for monitoring the health of workers at the mine as may be required under Part 3 of the WHS Regulation
- (e) the management of health records (including first aid records) of workers at the mine or petroleum site.

To determine whether there are hazards that may have long-term effects on mine workers' health, consider situations workers may be exposed including, but not limited to:

- > the materials, substances or fumes workers may be exposed to and the likely consequences of any such exposure (i.e. silica dust, asbestos, diesel particulates, welding fumes, chemicals and so on)
- > the type of tasks undertaken (e.g. working outdoors, working in extremes of temperature, manual handling) and the place in which they are undertaken
- > the equipment or tools being used and how workers interact with them (e.g. noise and vibration)
- > the length of time workers may be exposed to any potentially hazardous material, fumes, substances or situations
- > the hours of work (including travel time to and from sites and shift work), sleep disruption, sleep deprivation and individual workload
- > the influence drugs or alcohol may have on a worker.

You cannot accurately assess the risk of some hazards without undertaking scientific testing or measurement by a competent person. This includes checking that relevant exposure standards are not being exceeded (e.g. by using noise meters to measure noise levels and dust deposition meters to measure airborne dust).

Extractive sites should undertake workplace and individual monitoring for the following hazards:

- > dust (including diesel particulates)
- > noise
- > vibration
- > welding fumes and gases (where applicable).

If the degree of hazard or risk is not clear, seek advice from an occupational health, occupational hygienist or occupational medical specialist.

The health control plan must contain information detailed in clause 1 of schedule 2 of the WHSMPS Regulation. In summary, the health control plan must address how the following hazards will be monitored and controlled:

- > noise and vibration
- > dust, diesel particulates and fumes
- > working in extremes temperatures and humidity
- > manual handling and lifting
- > electro-magnetic hazards (e.g. workers with pacemakers)
- > hours of work and fatigue
- > ultraviolet and ionising radiation
- > biological hazards
- > hazards associated with the consumption of drugs or alcohol
- > any other hazard that may adversely affect the health of workers.

The health control plan should be developed in the context of the whole health and safety management system and not in isolation from other plans, processes and procedures that rely on the control plan. This will ensure gaps and overlaps in information and procedures are identified and used in the implementation of suitable controls to minimise the likelihood and potential risks and impacts.

15.2 EXPOSURE MONITORING

Health hazards have varying effects on human health and are dependent on the dose or level of exposure. The longer a worker is exposed to a hazard or agent, the greater probability is of an unfavourable outcome.

Exposures standards are scientifically established and exist for a variety of chemicals including airborne contaminants and other hazards such as noise.

The exposure standards are set by SafeWork Australia and this information can be found in the Hazardous Chemical Information System (HCIS). There are three components to the exposure standard and each have a different effect on the body. These are the:

- > eight-hour exposure standard, which calculates the concentration over an eight-hour day, five days a week
- > short term exposure limit (STEL), which is calculated over a 15-minute period with a number of rules that outline exposure over an eight-hour shift.

15.3 HEALTH MONITORING

As part of the Primary duty of care (section 19 of the WHS Act), all PCBUs must ensure, so far as is reasonably practicable, that the health of workers and the conditions at the workplace are monitored for the purpose of preventing illness or injury of workers arising from the conduct of the business or undertaking.

The WHS Regulations place specific duties on a person conducting a business or undertaking to provide health monitoring to workers who use hazardous chemicals, including workers who are exposed to lead and asbestos.

The WHSMPS Regulation allows for the regulator to direct PCBUs to provide health monitoring to workers.

Health monitoring refers to monitoring the effect of exposure to a hazard on an individual rather than monitoring the air or other aspects of the work environment. For example, if workers are exposed to lead, blood tests can show how much lead they have absorbed.

Health monitoring can take several different forms depending on the type of substance that workers are exposed to including:

- > interview
- > medical examination
- > biological monitoring such as blood and other tests. Some tests are able to detect the exposure while other tests are able to measure the effect the exposure has on the person, such as X-rays

There are specific requirements for health monitoring where workers are exposed to hazardous chemicals. This includes exposure to silica, diesel emissions, welding fumes and lead. SafeWork Australia has a range of guides on health monitoring including for PCBUs, workers and doctors.

Consult with workers before choosing a medical practitioner or nurse to carry out the health monitoring (or medicals). Health monitoring must be supervised by a registered medical practitioner with experience in health monitoring.

Health monitoring reports and results must be kept as confidential records and must not be disclosed to another person without the worker's written consent, except where the records are required to be given under the WHS Regulations to any of the following:

- > the regulator
- > another PCBU who has a duty to provide health monitoring for the worker
- > a person who must keep the record confidential under a duty of professional confidentiality (e.g. a doctor).

Health monitoring reports should be kept separate from normal workers' records like payroll or human resources data to prevent the reports being accessed inadvertently by unauthorised people. The report cannot be used for any purpose other than for health monitoring.

Health monitoring records for all workers must be kept for at least 30 years after the record is made, even if the worker no longer works at your workplace. For asbestos health monitoring, these records must be kept for at least 40 years, because of the long time it can take for asbestos-related disorders to develop.

Baseline health monitoring is required in some cases including for exposure to crystalline silica and diesel emissions⁹.

(Note: baseline health monitoring when a person starts work is different from fitness for work or pre-employment medicals. Pre-employment medicals are not legally required and any arrangements for them are only as agreed between you and the worker.)

15.4 NOISE

Loud noise can cause irreversible damage to a worker's hearing, as the cochlear (part of the inner ear) has tiny, hair like cells called stereo cilia (vital for the transmission of sound energy) that are damaged or immediately destroyed by exposure to frequent and/or loud noise. These hair like cells do not regenerate.

You must take all practicable steps to ensure workers are not exposed to noise levels above 85 dB averaged over an eight-hour period (referred to as LAeq,8h of 85dB(A)), and a peak noise level of 140 dB (referred to as LC,peak of 140dB(C)). These values are taken regardless of whether a worker is wearing a personal hearing protection device.

The 85 dB(A) exposure limit is based on an eight-hour working day and it is highly likely extractive operations will need to take into account extended shifts in any noise assessment if they work shifts longer than eight hours.

This is due to the longer period of time a person is exposed to potentially hazardous noise and the shorter time the person's ears have to recover before noise exposure resumes. Situations may also exist when the longer exposure time is a key factor in noise exposure exceeding the exposure limits.

Much can be achieved by careful design and maintenance of equipment and possibly by changing work practices.

Methods for reducing exposure include:

- (a) using low noise machinery, many extractive sites equipped with modern machinery and vehicles achieve noise exposures below workplace exposure standards
- (b) reducing sound radiating surfaces (e.g. using mesh guards instead of plate metal)
- (c) vibration isolation (e.g. operators' cabins and vehicle cabs)
- (d) using sound absorbing linings (e.g. in vehicle cabs and engine cover linings)
- (e) using exhaust silencers (e.g. on pneumatic drill rigs and vehicle engines)

⁹ SafeWork Australia Hazardous chemicals requiring health monitoring. Note that one of the chemicals in diesel emission is Polycyclic aromatic hydrocarbons (PAH)

- (f) using enclosures around equipment (e.g. to control noise in workshops)
- (g) using noise refuges for workers (e.g. a cabin at the control console of crushing and screening equipment)
- (h) maintenance (e.g. replace defective silencers and repair broken windows in vehicle cabs).

Such measures may be used alone or in combination. The list is not exhaustive and other techniques may be applicable. Many effective solutions are low cost.

Personal protective equipment (PPE) such as ear protectors should only be used as an interim solution. It may be used long-term when all other reasonably practicable measures have been taken but have not in themselves achieved adequate noise reduction. Reducing noise exposure is the main objective.

For more detailed information on noise control methods see the SafeWork Australia *Managing noise and preventing hearing loss at work code of practice*. This includes information on workplace exposure standards, work environment monitoring and personal protective equipment (PPE).

15.5 **VIBRATION**

There are two types of vibration that may cause harm to workers. Whole body vibration (WBV) and hand-arm vibration (HAV).

WBV is the vibration and shock you feel when you sit or stand on a vehicle or machine travelling over rough ground or along a road.

It can also be the vibration when you work near powerful machinery such as a rock crusher. Shocks can occur, for example, when driving over bumps or potholes.

Exposure to WBV at low levels is unlikely on its own to cause injury but it can aggravate existing back injuries, which may cause pain.

Effects of long-term exposure to WBV include:

- > disorders of the joint and muscle disorders, especially the spine
- > cardiovascular, respiratory, endocrine and metabolic changes
- > digestive system problems
- > reproductive damage in women
- > vision or balance impairment
- > discomfort and interference with activities.

HAV is the vibration and shock transmitted to hands and arms when using hand-held powered tools or equipment that vibrate while in operation.

HAV can cause hand-arm vibration syndrome (HAVS) and carpal tunnel syndrome (CTS) that can be debilitating. The risk of developing HAVS or CTS depends on the length of time a person is exposed for and the magnitude of the vibration.

Consider if tasks using vibrating plant can be completely removed from the workplace. For example, introduce remotely controlled mobile plant rather than plant driven by workers.

If it is not reasonably practicable to eliminate the risk, then consider implementing the following options in the order they appear below to minimise that risk:

- > Substituting the hazard with something safer including buying or hiring mobile plant that has lower vibration emission or is more suited to the task (e.g. where forklifts are regularly used in unpaved loading yards using a forklift designed for this use rather than one designed for indoor use).
- > Isolating the hazard from people (e.g. isolating or dampening a work platform to eliminate or minimise vibration from a motor using rubber mounts and flexible connection).
- > Using engineering controls (e.g. installing seats on mobile plant designed to minimise vibration, selecting tyre types suitable for the terrain and maintaining suspension, roadways and tyres).

If after implementing the above control measures a risk remains, consider the following controls in the order below to minimise the remaining risk:

- > Use administrative controls (e.g. implementing speed limits on gravel or dirt roads or introducing a roster system to minimise how long each worker is exposed to WBV).
- > Use personal protective equipment (PPE) (e.g. workers standing on a vibrating platform may benefit from shoes with soles designed to reduce transmission of vibration to the feet. In most cases PPE is unlikely to be effective on its own as a control measure to reduce WBV exposures).

In summary, reduce and control vibration exposure by:

- > maintaining plant, equipment and vehicles
- > reducing speed
- > designing and constructing machinery and vehicles to lessen vibration emission
- > maintaining roadways and other vehicle operating areas
- > buying or replacing hand-held tools with ones with less vibration emission
- > buying or replacing machinery or vehicles with ones with less vibration emission
- > reducing time spent using hand-held tools or driving
- > organising work and designing workstations to avoid uncomfortable postures and the need for high manual effort to grip, push or pull equipment
- > providing personal protective equipment (e.g. gloves).

15.6 ATMOSPHERIC CONTAMINANTS

There are two types of airborne contaminants these include:

- > inhalable – particles that are inhaled but are too large to reach the narrowest areas of the lungs where the body's natural defence systems typically expel the dust particle
- > respirable dust – dust that reaches the narrowest areas of the lungs where the contaminant can become trapped causing the body's natural defence system to respond.

15.6.1 DETERMINING IF THERE IS A DUST HAZARD

The method of determining if there is a dust hazard is wide, variable and sometimes haphazard. There is a misconception that if a rock has low silica then the risk is low and therefore there is no need to do monitoring. Clause 50(1) WHSR states a PCBU must ensure monitoring of the concentration of a substance at a workplace is carried out to which an exposure standard applies, if they are not certain on reasonable grounds whether or not the airborne concentration exceeds the relevant exposure standard.

Now clause 39(1) WHSMPS Regulation limits the time weighted average (TWA) for respirable dust (any dust) to 3 mg/m³ of air and for inhalable dust it is 10mg/m³ of air. It is the respirable dust that causes long term damage and disease to the lungs and inhalable dust causing eye, nose and throat irritations, asthma and bronchial issues.

Additionally, clause 39(2) WHSMPS Regulation then applies the workplace exposure standards (WES) for airborne contaminants and respirable concentration of silica is limited to 0.1mg/m³ in air.

So, there are two parts to dust on site, being:

- > respirable and inhalable dust, and
- > silica dust (limited by WES).

So, unless you can absolutely be certain that dust exposure levels are less than that specified above, operators will need to undertake monitoring to determine if there is a risk present.

(Note: exposure levels are measured on the person. A one-off monitoring exercise will show if there is a risk from dust present and should be repeated at regular intervals or when the type of rock being mined changes significantly.)

15.6.2 RESPIRABLE DUST

One of the health risks from working at an extractive site is the exposure to fine dust, containing particles that may lead to chronic and possibly fatal lung disease. Respirable dust does not have to be visible or irritating to seriously impact on health.

Workers may be exposed to fine dust from:

Hand-operated drills or grinders mainly used in monumental stone quarrying and processing.

Drilling rigs used mainly for drilling holes for blasting, exploration or ground support.

Crushing or milling: Compressive-type crushers produce dust but do not themselves induce excessive air movement, although moving materials do and dust, either from the materials or the actual crushing process, becomes airborne. Impact-type crushing machines involve a rotating part which acts as a fan and generates considerable air movement. With this type of high-reduction crushing, considerable quantities of airborne dust are generated.

Screens used to extract or reject specific-sized material from the feed product. Screening equipment creates dust by degradation and the action also affects the release of dust in the material.

Conveyors, feeders and loading used to transfer product from one position to another. Dust is released from the transfer points and can be aggravated if not enclosed and protected from wind. It is also released as the dusty product travels when the conveyor is moving and the air lifts the dust.

Heating or drying of rock fragments inevitably causes large emissions of airborne dust, unless exhaust gases are fully treated.



Bagging dry materials, particularly powders, and bag damage. Bagging products while damp does not present any dust problems.

Portable hand-operated saws generally used in monumental stone and slate quarries for the cutting of stone and for the creation of slits so wedges can be used for splitting.

Static saws: a wide range of saw types are used for cutting blocks of stone and slate into selected sizes. Most saw blades are diamond tipped and use water for cooling. The water also acts as dust suppression.

Splitting or dressing takes place at monumental stone and slate quarrying operations. Some splitting involves drilling small diameter holes and using plug and feathers or hydraulic splitters. Using chisels for splitting or grinders for dressing of slate creates dust in the operator's breathing zone and the hand dressing of stone (masonry work) also creates dust emissions.

Laboratory processes including sorting, sieving and processing test samples of crushed materials.

Traffic on haul roads kicking up dust into the air. Fully enclosed cabs and watering haul roads can help control this hazard.

Other activities including stacking, cleaning (especially when using brooms) and driving are a source of dust. Assess personal dust exposure during these activities.

Hazard controls must include reduction at source. For example:

- > dust collectors on drills and dust suppression sprays and other dust collection equipment
- > water applied directly to the drill tip and water supply to saws
- > screen hoods
- > encapsulation
- > extraction systems
- > integral units in buildings
- > watering of haul roads with or without additives
- > stockpile dampening
- > rehabilitating exposed surface areas including tree planting or re-grassing.

Control measures must be maintained in an effective state, in efficient working order and in good repair. Where engineering controls are implemented, thorough examinations and tests should be carried out regularly.

15.6.3 DIESEL PARTICULATES

The physical properties of diesel engine exhaust means it can accumulate in an enclosed space where there is an insufficient rate or quality of ventilating air. Diesel fuel produces harmful emissions made up of aerosols, vapours, gases and particulates when not fully combusted. Exhaust from diesel engines is more likely to produce harmful health effects over regular fuels because of its higher ignition point.

Most extractive sites are likely to use diesel engines. Workers near diesel powered equipment may be exposed to diesel emissions or diesel particulate matter. Situations of particular risk include confined spaces, workshops or when working in deep pits where temperature inversions can cause exhaust fumes to be trapped in the pit.

To be successful in reducing and controlling the hazards associated with diesel engine exhaust, a whole of site approach is required.

This will require co-ordination of expertise and a high level of process discipline in many functions including:

- > management
- > maintenance
- > engineering and ventilation
- > training
- > supply and procurement.

Engineering controls are the most effective strategy for reducing the exposure to diesel emissions and diesel particulate matter.

Administrative controls (including changes to the way work tasks are performed) and personal protective equipment may also be required.

Controls include:

- > good ventilation – an essential control measure in enclosed work environments and workshop areas (provide 0.06m³ of ventilation current for each kW of engine power)
- > controlling the amount of diesel vehicles or plant operating in an area
- > maintaining well-tuned engines
- > use of low sulphur fuels
- > use of alternate power engines such as electric or propane
- > improving road conditions, such reducing pot holes, will help reduce the over-revving of the engine.
- > educating workers on how driver behaviour affects emissions
- > catalytic converters on diesel equipment can assist in reducing harmful emissions by more fully oxidising organic substances
- > fully enclosed and well-sealed driver cabins.

15.6.4 WELDING AND GAS CUTTING FUMES

Welding fumes are a complex mixture of metallic oxides, silicates and fluorides. Fumes are formed when a metal is heated above its boiling point and its vapours condense into very fine particles (solid particulates). Welding gases are gases used or produced during the welding and cutting processes. Examples are shielding gases, gases produced by the decomposition of fluxes, from the interaction of ultraviolet light, high temperatures with gases or vapours in the air.

Exposure to welding gases and fumes can be fatal. You cannot rely on the sense of smell to detect any of these hazards. Some cannot be smelled at all and the sense of smell can become insensitive to those odours it can detect.

Further information on welding hazards is outlined in section 16.1.5.

For more detailed information on welding safety, including methods of fume control, see the NSW *Welding processes code of practice*.



15.6.5 LEGIONNAIRES' DISEASE

Legionnaires' disease (legionellosis) is a type of pneumonia caused by the legionella bacteria that may be found in water systems. Infection is caused by inhaling fine water droplets containing the viable bacteria.

There is no evidence to suggest that mining and quarrying present a heightened risk of exposure to legionella compared to other industries, however, large quantities of water can be used at extractive sites for dust suppression and processing and this raises the potential that legionnaires' disease may be a hazard.

Risk factors include water, growth temperature range of 20°C to 45°C, nutrients (i.e. biofilm or algae, rust and scale) and aerosol, spray or mist. Mines and quarry water supplies typically use non-mains supply sourced from bore holes or lagoons. It is usually recycled and prone to contamination by process dust and environmental material such as soil and plant material. Stored water in tanks or pipes may be stagnant for periods and in warm weather the temperature may rise above 20°C.

The following water systems are likely to include the risk factors described above, however this list is not exhaustive:

- > water being sprayed on to material by fogging cannons or directional misting units
- > water being sprayed on to materials for wet suppression of dust at transfer or discharge points
- > water being sprayed on to roads for wet suppression of dust using water bowsers or fixed sprays
- > use of hoses to clean areas of hard standing around processing plant and site buildings
- > water spray from vehicles or wheel washers
- > use of water as part of the production process such as barrel washers, wet scrubbers and cooling of cutting blades on saws
- > water curtains for dust control such as for dimensional stone cutting and processing
- > emergency showers.

Appropriate control methods should focus on limiting the conditions that encourage growth. In some instances, it may be necessary to employ specialist technicians to sample and test suspect water sources.

By applying simple, low cost measures, the potential for growth and thereby the potential for exposure can be significantly reduced and appropriately controlled.

15.7 WORKING IN EXTREME TEMPERATURES

Working in very cold and very hot temperatures can be hazardous to a worker's health.

Excessive exposure to heat is referred to as heat stress and excessive exposure to cold is referred to as cold stress.

In a very hot environment, the most serious issue is heat stroke, which can be fatal. Heat exhaustion and fainting (syncope) are less serious but can still affect a person's ability to work.

In very cold temperatures, the most serious issue is hypothermia (or dangerous overcooling of the body), which can be fatal.

Another serious effect of cold exposure is frostbite or freezing of the exposed extremities such as fingers, toes, nose and ear lobes.

Sufferers of heat stroke and hypothermia are unable to notice the symptoms, so their survival depends on co-workers' ability to identify symptoms and seek immediate medical help.

Where workers are, or could be, required to work in extreme temperatures, implement controls to eliminate or minimise the risks. As with other risks, the risk of heat stress must be managed using the hierarchy of control.

Controls should be directed towards the:

- > work environment
- > task being carried out
- > individuals.

Examples of controls include:

- > ventilation including fans, blowers and chillers
- > air conditioning including crib rooms and vehicle cabs
- > insulation or shielding including tents and shade
- > training and education
- > employment assessment and monitoring
- > setting patterns of work including adjustment of shifts so physical work can occur in cooler periods of the day, regular breaks and work rest scheduled and cool rest or recovery areas
- > acclimatisation schedules
- > self-pacing of work
- > hydration
- > PPE – cool vests

Consideration should also be given to work patterns.

15.8 HAZARDOUS MANUAL TASKS

A hazardous manual task (HMT) as defined in the work health and safety legislation is a task that requires a person to lower, lift, push, pull, carry, move, hold or restrain any person, animal or thing and has the following characteristics involved:

- > force that is repetitive, sustained, high or sudden
- > awkward or sustained postured
- > repetitive movements
- > vibration exposure

Hazardous manual tasks can result in serious back injuries, musculoskeletal disorders (MSDs), acute injuries (e.g. sprains and strains) and injuries sustained through slips, trips and falls.

Most common assessment tools are not suited to identifying manual handling and other hazards associated with MSDs.

To select the best control measures for your operation, it is a good idea to start with a targeted risk assessment of MSD risks using a MSD specific risk assessment pro-forma. Refer to NSW Hazardous Manual Tasks Code of Practice.

Assess the manual handling tasks undertaken at your site and determine whether they are necessary. If they are, and you cannot eliminate manual handling by providing suitable lifting equipment, then you should make the task as easy as possible for everyone involved and reduce the time people are required to do it.



For many manual handling tasks there may be several control options that appear feasible. Some of the control options may need to be trialled and evaluated before they are finally implemented (to identify whether they are appropriate for that specific system). This trialling can be relatively quick and informal, or may need to be formal and extensive, to get the best solution possible.

15.8.1 USE OF SCREENS

Screens are a critical part of the process of producing aggregate materials. However, the use of screens and in particular their maintenance and repair pose a number of health and safety risks including risks of MSDs. The following controls should be considered to eliminate or minimise MSD risks associated with screens.

Elimination

- > do you need a screen?
- > eliminate the need to enter a screen.

Design controls

Design refers to a control strategy that involves redesigning the screen layout, workplace or the task or tool to reduce the risk. Design controls include substitution and engineering controls.

SUBSTITUTION

- > Provision of lighter screen media.
- > Provision of gantries or lifting equipment.
- > Upgrade of screens to include rollaway chutes for easier access.

ISOLATION

- > Change and inspect screens remotely.

ENGINEERING

- > Redesigning and upgrading the screen plant to allow more height between decks (preferably 500mm as a minimum)
- > Design and construction of media that can be replaced via an automated process such as a spooling technique or a cassette deck.
- > Use of CCTV portable and mobile cameras to inspect screen media
- > Design of tension and fixture locations so that they are easily accessible by workers and do not require entry into the screen compartment.

Administrative and Personal Protective Equipment (PPE) controls

Administrative controls are far less effective than design controls. Rather than controlling the risk directly by designing out the hazard, administrative controls rely on the behaviour or actions of the worker or supervisors to control the risk. Administrative controls are best used as part of a comprehensive control strategy, to compliment design control or for short term risk management.

Personal protective equipment is again less effective than design controls as they rely on the human to manage the risk by wearing and fitting their PPE correctly. It should be noted that PPE is the least effective in minimising risk. PPE includes ear muffs, face masks, hard hats, gloves etc.

For more information see the guide *Managing screens and screen maintenance in extractive mining*.

15.9 HOURS OF WORK AND FATIGUE

Fatigue is a physical and mental state caused by a range of influences. It reduces a person's capabilities to an extent that may impair their strength, speed, reaction time, coordination, decision making or balance.

A level of fatigue is a natural response to the mental and physical effort of everything we do. Normally, good quality sleep reverses the imbalance, allowing the body and the brain to recover. However, long working hours, working with intense mental or physical effort, or working during some or all of the natural time for sleep can all cause excessive fatigue.

People may work extended hours for long periods of time. Night shifts are also possible as are strenuous physical activities. Travelling to and from the worksite can add hours to the working day, as sites can be remote.

Preventing fatigue begins with careful planning of tasks and their scheduling. Tasks should be designed so extreme exertion (mental and physical) are avoided and there is sufficient recovery time available.

Controls can include:

- > Roster patterns that allow for adequate sleep and life activities (eating, washing and family).
- > Shift durations that consider workers commute times to allow for adequate sleep and life activities.
- > Allow a 48-hour break after night shifts.
- > Roster no more than 50 hours of work per week per worker.
- > Increase supervision during periods of low alertness (e.g. 3am to 5am).
- > Provide training and information on the risks of shift work and ensure supervisors and management can recognise problems.
- > Ensure breaks for workers to eat and nap if needed.

Working hours should be agreed that provide all workers adequate opportunity to manage fatigue, including:

- > regular rest breaks
- > meal breaks
- > avoidance of excessive alcohol consumption
- > a daily or nightly sleep period
- > shared driver responsibilities.

Meal and rest breaks for employees must comply with any award requirements. For information contact:

- > NSW Industrial Relations www.industrialrelations.nsw.gov.au/
- > Commonwealth Fair Work Commission <https://www.fwc.gov.au/>

15.10 MENTAL HEALTH

Psychosocial hazards or mental health for the purposes of this guidance include stress, bullying and violence. Stress can be a reaction to bullying and violence. Violence may also result in physical harm.

Violence is a hazard that may be encountered at work. It can occur suddenly, without notice or provocation. It may cause mental and physical pain and suffering and may result in permanent disability or death.

Bullying affects people physically and mentally, resulting in increased stress levels, decreased emotional wellbeing, reduced coping strategies and lower work performance.

We all experience stress at different times, to varying degrees. When we feel that work is leading to concrete, achievable and worthwhile goals, we almost always rise to the occasion, even with severe difficulties. Where there are urgent deadlines, work overload, poor relationships or other stressors, we mostly cope – if there is a return to ‘normal’ in a reasonable time. But, when a ‘stressful’ situation is ongoing or severe or has the potential to cause mental or physical illness, then it becomes a concern. In these situations, the WHS Act requires the situation to be managed. Work-related stress is not an illness, but can lead to increased problems with ill health if it is prolonged or particularly intense. Examples are heart disease, raised blood pressure, regular headaches, back pain, gastrointestinal disturbances and various minor illnesses. Psychological effects can be anxiety and depression.

Take proactive steps to make work healthy, build morale, identify and deal with stressors and talk with workers.

There are several key points that should be considered when developing a health control plan to address mental health. The aim should be to achieve the best fit between the working environment, the systems of work and the needs and capabilities of workers. Some effective controls include:

- > to reduce workplace violence placing a barrier between an aggressive person and the person interacting with that individual
- > placing barriers to reduce noise from a noisy environment and the work area
- > defining the job so individuals are aware of their scope of work requirement
- > better job planning to ensure a balance between work demands and time pressures
- > consulting with workers when setting targets
- > providing support systems within the workplace such as a mentoring
- > planning, management and communication for organisational change
- > training, induction and instruction on workplace behaviour (e.g. prevention of bullying and harassment at the workplace)
- > addressing workplace factors that may affect the mental health of employees
- > effective and available employee assistance program for employees
- > supervisors trained in recognising and supporting employees experiencing mental ill health
- > guidelines addressing mental health developed and disseminated
- > ensuring the management of critical events occur in a manner that reduces psychological risks. (SafeWork Australia, 2017)
- > regularly review control measures to make sure they are effective

SafeWork NSW has information and several tools to help with mental health at workplaces.

Bullying

Bullying in the workplace is defined as ‘repeated, unreasonable behaviour directed towards a worker or group of workers that creates a risk to health and safety’. A single incident or reasonable workplace action is not bullying.

Information provided by SafeWork NSW and SafeWork Australia in relation to bullying is applicable to all workplaces across NSW.

Examples of potential unreasonable behaviour include:

- > offensive language or comments
- > unjustified criticism
- > deliberately excluding someone from workplace activities
- > withholding information that is needed for work.

SafeWork Australia's *Guide for preventing and responding to workplace bullying* outlines what workplace bullying is and how to prevent, respond to and investigate it. SafeWork Australia also has guidance for workers.

15.11 ▶ **ULTRAVIOLET RADIATION**

Short term exposure to the sun can result in sunburn and eye injuries. Prolonged exposure to sunlight is a well-established cause of skin cancer, including melanoma. It is the ultraviolet (UV) radiation component of sunlight that is harmful. Even on cloudy days, the UV level may be sufficient to be harmful. Long-term effects on the eye include damage to the cornea and formation of cataracts.

The risk of skin cancer is higher for outdoor workers because of their prolonged sun exposure. Intense periods of exposure to the sun appear to be the most significant factor for melanoma. While people with certain skin types may be at greater risk, it is important that everyone protects their skin from prolonged exposure to solar UV radiation.

Workers may be exposed to non-ionising radiation from arc welding. People working near welding operations are at risk of 'arc eye' or 'welding flash', a painful condition.

Work processes must ensure the risk posed by exposure to UV radiation is reduced. In some instances, this may be achieved by simply changing the time of day when a task is carried out. Where this is not practicable, protection should be provided including working undercover and providing personal protective equipment.

15.12 ▶ **CONTAMINATED LAND**

Redevelopment of contaminated land, which may be associated with opencast mining or quarrying, can result in exposure to contaminants. The health effects, control measures and surveillance required will depend on the nature of the contaminants encountered. Specific advice from an occupational medical specialist should be sought before redevelopment commences.

15.13 ▶ **HAZARDOUS SUBSTANCES**

Hazardous chemicals are mixtures, substance and or materials that are categorised according to their risks and dangers. Hazards associated with hazardous chemicals depend on the type of substance and the environment in which it is being used. Change processes to eliminate exposure to hazardous substances or replace them with safer alternatives. Refer to the safety data sheet (SDS) for the precautions required for each individual substance.

Exposure to hazardous chemicals can cause dermatological issues if absorbed through the skin or respiratory issues if they are inhaled. Chemicals are used in various applications of mining including solvents, hydro-carbon based chemicals, acids and alkalis.

Dermatological issues can include chemical burns and dermatitis and can be classified as:

- > occupational contact dermatitis
- > irritant contact dermatitis
- > allergic contact dermatitis



When assessing the risks, things to consider are the effects of exposure to hazardous chemicals, latency period and propensity for reoccurrence:

- > acute – effects occur within hours of exposure
- > chronic – effects occurs after repeated exposure
- > latency – the period of time it takes before symptoms manifest

Hazardous chemicals can be in the form of:

- > dust – airborne solid particles
- > fibres – solid particle where length is longer than width
- > fumes – airborne solid particles condensed from a vaporous state
- > mists – airborne droplets of substance
- > smoke – particles generated from incomplete combustion of fuel
- > vapour – molecular dispersion of material, normally liquid at ambient temperature
- > gas – molecular dispersion of material, boils below ambient temperature.

Exposure to hazardous chemicals can cause:

- > irritation
- > respiratory diseases (e.g. pneumoconiosis, silicosis).

The hierarchy of controls, when applied to managing risks, looks at first eliminating the need for the use of a hazardous chemical. Isolation controls would predominantly look at putting a barrier between the worker and the chemical. Engineering controls either look at ways to withdraw hazardous substance from the atmosphere such as extraction fans/flumes and ventilation or improve the atmosphere by using ventilation. Substitution of a hazardous chemical for a chemical that is less hazardous is the most commonly practiced control, due to its practicality. Training and procedures for use of hazardous chemical are the most commonly used administrative controls or control supports. Personal protective equipment or respiratory protective equipment are also used as a control.

15.13.1 MERCURY

Mercury can be present in precious and base metal ore and is produced as a by-product of gold and silver processing. Mercury is a very toxic cumulative poison that can affect the brain, the central nervous system and the reproductive system. It can be absorbed by inhalation, ingestion and through the skin.

Mercury poisoning can result from both acute and chronic exposures. It is critical to recognise that exposure to mercury can be without warning and workers may not know the extent to which they have been contaminated. Personal, environmental and biological monitoring should be done to determine the exposure hazard and evaluate symptoms as necessary.

Information, training and supervision on the hazards associated with mercury should be given to workers on site.

For more detailed information see:

- > Safety data sheets for precautions and other hazardous substance information.
- > *Managing risks of hazardous chemicals in the workplace code of practice*
- > Workplace exposure standards for airborne contaminants (WESFAC).

Another useful publication is the USA Department of Labor Mine Safety and Health Administration (MSHA) Best Practices section of the *Controlling Mercury Hazards in Gold Mining: A best practices toolbox*.

15.14 DRUGS AND ALCOHOL

People may be under the influence of alcohol or drugs while at work. This applies whether they are injected, inhaled or taken orally. The availability of legal medication and prescription medication may increase the risk of drug-impaired performance by workers. The abuse of drugs or alcohol can be on-site or off-site, such as heavy drinking the night before a day shift. Mine operators have several responsibilities in relation to drugs and alcohol.

Under clause 44 of the WHSMPS Regulation mine operators must manage the risks to health and safety associated with the use of drugs or consumption of alcohol by workers. Operators must consult with workers when developing and implementing strategies to protect them and others from any risk to health and safety arising from the consumption of alcohol and the use of drugs.

Furthermore, clause 104 of the WHSMPS Regulation declares that the operator of a mine or petroleum site must ensure that workers are provided with suitable and adequate information, training and instruction in relation to the implementation of control measures relating fatigue, the consumption of alcohol and the use of drugs.

These control measures must be included in the health control plan.

Workers have a duty to take reasonable care to ensure their own safety, and alcohol and drugs may affect their ability to do this. All operations large and small can benefit from an agreed drug and alcohol policy, applying to all workers. Such a policy should form part of your organisation's overall health and safety policy. A written drug or alcohol policy has many advantages, including leaving less room for misunderstanding. Key elements of a drug or alcohol policy include:

- > a statement on why the policy exists and who it applies to
- > who is responsible for enforcing the policy
- > a definition of drug or alcohol misuse
- > how the operation expects workers to behave
- > statements that make it clear how absence for treatment and rehabilitation will be recorded. Examples include sick leave, recognition that relapses may occur and how these will be dealt with, and how the policy will be reviewed and consulted on
- > a statement on confidentiality so workers can be assured a drug or alcohol problem will be treated in strict confidence, subject to law
- > a description of support available to workers who have a drug or alcohol problem
- > a commitment to providing workers with general information about the effects of drugs or alcohol
- > the circumstances in which disciplinary action will be taken.

The policy should also outline site rules for workplace events where alcohol is being served. This may include:

- > approving any event where alcohol may be served
- > carefully managing alcohol consumption
- > designating drivers or providing transport if travel is needed after an event
- > ensuring non-alcoholic refreshments and food are available
- > keeping work vehicle keys safe
- > making sure workers do not work after the event if they're still affected by alcohol (including the next day where relevant).

It is an offence to supply alcohol to anyone under 18 years of age.

15.15 PERSONAL PROTECTIVE EQUIPMENT (PPE)

PPE should only be considered as a hazard control where you have not been able to eliminate or isolate the hazard. PPE should always be used in conjunction with a documented safe system of work.

PCBUs must ensure all appropriate PPE is provided to workers and they are trained in its correct use and storage. PCBUS must make sure PPE is:

- > suitable for the task
- > suitable for the worker
- > used correctly
- > maintained to be clean, hygienic and in good working order

(Clause 44 WHS Regulation).

Where the following types of PPE are required, the specifications and use of these are detailed below:

15.15.1 HIGH-VISIBILITY CLOTHING

High visibility clothing should comply with AS/NZS 4602.1 *High visibility safety garments – Part 1: Garments for high risk applications* or any other Standard embodying the same or more stringent criteria.

High visibility clothing is to be worn on the outside of other clothing and not cause additional hazards (e.g. entanglement).

15.15.2 SAFETY FOOTWEAR

Workers engaged in extractive operations should wear protective footwear which provides foot and ankle support, traction and protection appropriate to the task they perform.

Where footwear requires protective toe caps they should comply with AS/NZS 2210.1 *Safety, protective and occupational footwear – Guide to selection, care and use* or any other Standard embodying the same or more stringent criteria.

When fitted, laces should be securely tied at all times.

15.15.3 SAFETY HELMETS

Safety helmets should comply with AS/NZS 1801 *Occupational protective helmets*. Helmets should be inspected regularly for damage and deterioration.

Helmets should be replaced immediately if damaged, or three years after the issue date (if recorded), or in accordance with the manufacturer's specifications. Where the issue date is not recorded the helmet should be replaced three years after the manufacture date that is moulded into the peak of the helmet.

15.15.4 HEARING PROTECTION

Hearing protectors should comply with AS/NZS 1270 *Acoustics – Hearing protectors* or any other Standard embodying the same or more stringent criteria.

15.15.5 EYE PROTECTION

Eye protection should comply with AS/NZS 1337.1 *Personal eye protection – Eye and face protectors for occupational applications* or any other Standard embodying the same or more stringent criteria.

People who wear prescription glasses can have these made to comply with the above Standard or alternatively safety glasses or goggles that can be fitted over prescription glasses are available.

15.15.6 GLOVES

Gloves should comply with AS/NZS 2161.2 *Occupational protective gloves*, AS/NZS 2161.3 *Occupational protective gloves – Protection against mechanical risks* or any other Standard embodying the same or more stringent criteria.

15.15.7 FALL ARREST SYSTEMS AND DEVICES

Fall arrest systems and devices should comply with AS/NZS 1891.1 *Industrial fall arrest systems and devices – Part 1: Harness and ancillary equipment* and AS/NZS 1891.3 *Industrial fall-arrest systems and devices – Part 3: Fall-arrest devices*, or any other Standard embodying the same or more stringent criteria.

Fall arrest systems should never be used as a primary hazard control. Develop a rescue plan before using a harness system. It is critical that a suspended or trapped worker can be promptly rescued. Typical injuries from falls can include unconsciousness and occluded airway, impalement, serious head or abdominal injuries and fractures.

A person conducting a business or undertaking who implements a fall-arrest system as a measure to control risk must establish emergency and rescue procedures.

The procedures must be tested so that they are effective. Workers must be provided with suitable and adequate information, instruction and training in relation to the emergency procedures.

(Clause 80 WHS Regulation)

A worker suspended in a harness can develop suspension intolerance. This is a condition in which blood pooling in the legs can lead to loss of consciousness, renal failure and, in extreme cases, death.

For more information refer to section 9 of the *Managing the risk of falls at workplaces code of practice*.

15.15.8 RESPIRATORY PROTECTIVE DEVICES

Respiratory protective devices used when there is potential for harm to workers exposed to dust, fumes, gases or chemicals should comply with AS/NZS 1715 *Selection, use and maintenance of respiratory protective equipment* and AS/NZS 1716 *Respiratory protective devices* or any other Standard embodying the same or more stringent criteria.

15.15.9 HAZARDOUS SUBSTANCE HANDLING

Personal protective clothing should be worn during the handling, mixing and application of chemicals or other hazardous substances. The protective clothing to be worn should comply with the instructions detailed on the manufacturer's safety data sheet (SDS) for the specific substance being used.

Personnel carrying out air condition work must hold a Current Refrigerant Handling License ARC code AAC02 issued by Australian Refrigeration Council on behalf of the Australian Government under the Ozone Protection and Synthetic Greenhouse Gas Management Regulations 1995.

15.15.10 HAZARDOUS CHEMICALS AND EXPLOSIVES

Many chemicals and fuels used in extractive operations are hazardous and are controlled under the WHS Regulation and Explosives Act & Regulation. Hazardous chemicals used in the extractive and surface metalliferous industry include:

- > explosives and detonators
- > compressed gases
- > some paints, adhesives and solvents
- > herbicides and pesticides
- > laboratory chemicals
- > petrol, diesel and liquefied petroleum gas (LPG).

15.16 HAZARD CLASSIFICATIONS

Hazardous chemicals are classified according to their hazardous properties. Under the Globally Harmonised System of Classification and Labelling of Chemicals (GHS) there are nine hazard pictograms in the GHS which represent the physical, health and environmental hazards. These are named: explosives, flammables, oxidisers, gasses under pressure, corrosives, acute toxicity, environmental hazard, harmful/irritant harmful to ozone layer and severe health hazards.

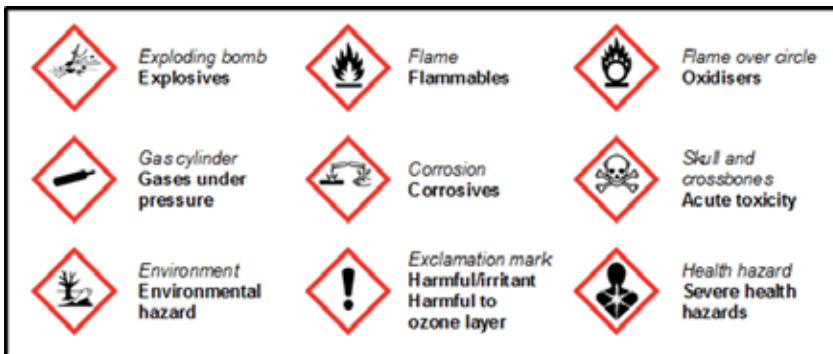

Figure 96. Examples of signs for various chemicals

The GHS uses 'Danger' and 'Warning' as signal words to indicate the relative level of severity of a hazard. 'Danger' is used for the more severe or a significant hazard, while 'Warning' is used for the less severe hazards.

According to the *Managing risks of hazardous chemicals code of practice*:

There are two broad types of hazards associated with hazardous chemicals which may present an immediate or long-term injury or illness to people. These are:

- > Health hazards – These are properties of a chemical that have the potential to cause adverse health effects. Exposure usually occurs through inhalation, skin contact or ingestion. Adverse health effects can be acute (short term) or chronic (long term). Typical acute health effects include headaches, nausea or vomiting and skin corrosion, while chronic health effects include asthma, dermatitis, nerve damage or cancer.
- > Physicochemical hazards – These are physical or chemical properties of the substance, mixture or article that pose risks to workers other than health risks, as they do not occur as a consequence of the biological interaction of the chemical with people. They arise through inappropriate handling or use and can often

result in injury to people and/or damage to property as a result of the intrinsic physical hazard. Examples of physicochemical hazards include flammable, corrosive, explosive, chemically reactive and sand oxidising chemicals.

Many chemicals have both health and physicochemical hazards.

Key duties in relation to hazardous chemicals include:

- > keeping a register of hazardous chemicals
- > notifying the regulator and keeping a manifest of if specified quantities of certain chemicals are used or stored (e.g. large amounts of petrol or LPG)
- > obtaining safety data sheets (SDS) for hazardous chemicals used at the workplace and ensuring it is readily available to workers, emergency service workers and anyone who is likely to be exposed to the hazardous chemical
- > ensuring that the hazardous chemical and any container or pipeline containing it is correctly labelled
- > the safe storage and handling of hazardous chemicals
- > providing information, training instruction and the correct protective gear (PPE) as indicated by the SDS to workers
- > requirements for emergency planning.

Know what hazardous substances are on site and how to manage them. Product labels and safety data sheets (SDS) provide information about the product's hazards and how to manage them. Manufacturers and suppliers must only sell correctly labelled substances and must provide compliant and up to date SDSs for hazardous substances.

SDSs contain important information about:

- > first aid
- > storage
- > cleaning up spills
- > the correct protective equipment such as PPE.

Make sure you have SDSs for all your hazardous substances. Contact your supplier who must provide them.

See the *Managing risks of hazardous chemicals code of practice* (available from SafeWork NSW) for more information on these duties and how to comply. SafeWork Australia also has a range of information on hazardous substances.

If you store, handle or process hazardous chemicals (dangerous goods) that exceed the quantities specified in the WHS Regulation, as well as notifying the regulator you must also develop a written emergency plan and lodge a copy with Fire and Rescue NSW.

16

PART D

Preventing falls from height

IN THIS SECTION:

- 16.1 Climbing on or off vehicles**
- 16.2 Access and egress to heavy vehicle working areas**
- 16.3 Covering loads**
- 16.4 Access to fixed plant and machinery**
- 16.5 Portable ladders**
- 16.6 Working near highwalls or faces**

Many falls from height are caused by a failure to plan and organise work properly and not having fit-for-purpose equipment. Start by planning a safe approach.

This section describes how to prevent falls when:

- > accessing onto or egressing from mobile plant
- > inspecting or maintaining mobile equipment
- > working around heavy vehicles
- > covering loads
- > accessing machinery
- > using ladders
- > working near highwalls or faces.

The WHS Act requires steps to be taken to prevent the fall from height occurring if there is any chance of harm resulting.

The SafeWork Australia *Managing the risk of falls at workplaces code of practice* provides a useful summary of obligations to manage the risks of falls from one level to another.

In managing the risks of falls, the WHS Regulations require the following specific control measures to be implemented,

where it is reasonably practicable to do so:

1. Can the need to work at height be avoided to eliminate the risk of a fall?
 - > Carry out any work that involves the risk of a fall on the ground
2. Can the fall be prevented by working on solid construction?
 - > A building or structure that is used as an existing place of work and includes safe access and egress from which there is no risk of a fall from one level to another, for example properly constructed stairs with fixed handrails, flat roofs with a parapet or permanently installed guard rails around the edges. It is usually not necessary to implement additional control measures to manage the risk of falls for workplaces in buildings that already comply with the requirements of the National Construction Code of Australia, for example in relation to stairs, mezzanines and balconies.
3. Can the risk of a fall be minimised by providing and maintaining a safe system of work, including:
 - > providing a fall prevention device (for example, installing guard rails) if it is reasonably practicable to do so, or
 - > providing a work positioning system (for example, an industrial rope access system) if it is not reasonably practicable to provide a fall prevention device, or
 - > providing a fall-arrest system, so far as is reasonably practicable, if it is not reasonably practicable to provide a fall prevention device or a work positioning system.

In some cases a combination of control measures may be necessary, for example using a safety harness while working from an elevating work platform



16.1 ACCESS AND EGRESS TO MOBILE PLANT

Access to heavy vehicles should be by a well-constructed ladder or steps. Ladders or steps should be well built, properly maintained and securely fixed.

A second means of egress shall be fitted to the machine from the operator's station which is not installed in an area likely to be blocked in the event of a fire on the plant.

Where a powered retractable ladders system is fitted it should meet the following requirements:

- > Movement shall stop when the control is released
- > It is visible from the control location
- > Have a control station fitted at both the top of the system and ground level
- > Be interlocked with the machine to inhibit movement when not in the stored position
- > Be able to be lowered without power where no other means of egress exists

Avoid using suspended steps wherever practicable. If they cannot be avoided, use rubber or cable suspension ladders, not ladders made of chains. Ladders should be vertical or slope inward towards the top. They should not slope outwards away from the top.

Rungs or steps on mobile plant should:

- > be level and comfortable to use
- > have a slip-resistant surface
- > not allow mud, grease or oil to build up dangerously (e.g. grating could be used to allow things to pass through a step).

The first rung or step should be close enough to the ground to be easily reached – ideally about 40 cm and never more than 60 cm. Place ladders or steps as close as possible to the part of the vehicle requiring access. Opening (and holding open) a cab door on a vehicle should not force a driver to break the 'three points of contact' rule or to move to an unsafe position.

Vehicle owners should consider retrofitting safer access ways to eliminate the risk of falling.

Refer to MDG 15 *Mobile and transportable plant for use on mines and petroleum sites*, AS 1657 *Fixed platforms, walkways, stairways and ladders - Design, construction and installation* and AS 3868 *Earth-moving machinery design guide for access systems* for further guidance.



Figure 97. A stairway and platform were retrofitted to this haul truck to increase driver access and egress safety



Figure 98. This excavator has a good access system, with platforms, guardrails, kick plates and ladder. The ladder is interlocked so the vehicle cannot be started without the ladder being raised

16.2 ACCESS AND EGRESS TO HEAVY VEHICLE WORKING AREAS

Wherever practicable, use walkways. Walkways should be made of slip-resistant grating (with enough space for mud or oil to pass through the grate and away from the walkway surface) or another slip-resistant material.

To prevent mud from making them slippery, position walkways, steps, ladders and handrails away from wheels if possible.

All exposed edges on platforms and walkways that could allow a person to fall from heights should be suitably controlled. This should be achieved through the installation of compliant guardrails or use of other suitable controls.

Top and middle guard rails are needed to protect people when they are standing or crouching. Consider collapsible rails. Mobile plant owners must fit guardrails if they are not already present (refer to Figure 99). If features are retrofitted to existing mobile plant, the alterations should not affect the structural integrity of the vehicle or the visibility of the operator.



Figure 99. Guardrails are fitted to this excavator to protect workers from falling from the machine during maintenance

16.3 COVERING LOADS

Loads must be covered whenever there is a risk of load shedding due to wind action or movement when travelling on a public road. Covering loads or removing covers can be hazardous, especially when carried out manually. Consider the risks associated with load covering and take effective measures to make sure covering and uncovering loads is done as safely as possible.

Consider the types of loads and vehicle, how often covering or uncovering happens and other specific characteristics of the workplace.

A method of covering and uncovering that does not involve getting on to the body of the vehicle or even touching the cover should be the first choice.

A hierarchy of solutions may look something like this:

- > leaving the load uncovered if it is safe to do so
- > using automated or mechanical covering systems that don't require people to go up on the vehicle (refer Figure 100)
- > using manual covering systems that don't require people to go up on the vehicle (refer Figure 101)
- > using work platforms to provide safe access to carry out covering from the platform without having to access the load (refer Figure 102)
- > using gantry or harness systems to prevent or arrest a fall (refer Figure 103).

Consider the following points regardless of which method of covering is used:

- > Do not overload the vehicle and try to load evenly to avoid the need for trimming.
- > Load evenly along the length of the vehicle (not in peaks) or as per axle load limits. Use a loader to pat down the load and flatten peaks.
- > Train and instruct staff on safe systems of work (and provide refresher training where necessary). Supervise and monitor covering and uncovering activities.
- > Regularly check covers are in good condition and replace when necessary. Visually check straps and ropes used for pulling and securing the cover.
- > Regularly inspect, repair and maintain covering mechanisms, platforms, gantries and lanyards.
- > During loading, unloading and covering, consider mobile plant used by workers of more than one company 'shared workplaces' and arrange for suitable controls to be followed by everyone concerned.
- > Ropes, straps and covers can snap or rip. The driver should avoid leaning backwards when pulling the cover tight. The use of elastic straps with metal hooks should not be used due to the risk of eye injuries.
- > Park mobile plant on level ground with their parking brakes on and the ignition key removed.
- > Cover mobile plant before leaving the site. Carry out covering and uncovering in designated places, away from passing mobile plant and pedestrians and, where possible, sheltered from strong winds and bad weather.

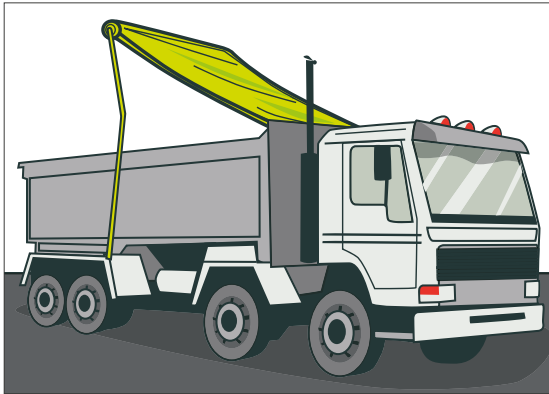

Figure 100. Automated covering system



Figure 101. Manual covering system



Figure 102. Platform covering system

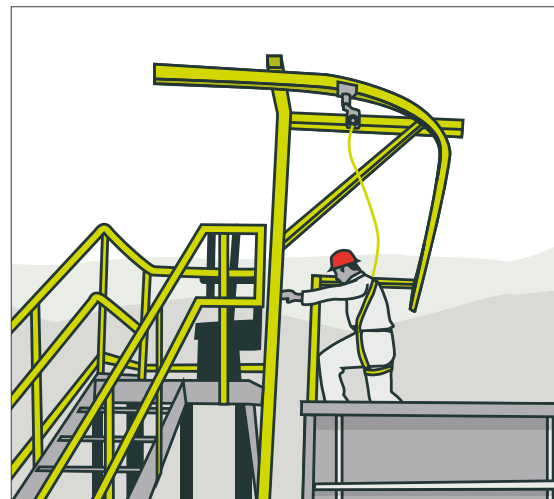

Figure 103. Overhead gantry harness system

16.4 ACCESS TO FIXED PLANT AND MACHINERY

For information on access to fixed plant and machinery see section 12.7.

For information on preventing falls while undertaking maintenance on fixed plant and machinery see section 17.1.1.

16.5 PORTABLE LADDERS

Portable ladders should comply with AS/NZS 1892.1 *Portable ladders metal* or any other Standard embodying the same or more stringent criteria.

All portable ladders should have their safe working load certified by the manufacturer and be inspected before every use for any damage.

Portable ladders should be used for low-risk and short-duration tasks. The user should maintain three points of contact with a ladder or stepladder to reduce the likelihood of slipping and falling. The top of ladders should be secured from slipping when possible.

Ladders and stepladders do not offer fall protection and therefore should be the last form of work access equipment to be considered.

For more information on ladders and stepladders see SafeWork Australia *Managing the risk of falls at workplaces code of practice*.

16.6 WORKING NEAR HIGHWALLS OR FACES

Any person who works on or near the edges of faces or high walls has the potential to fall. Typically, these can be the driller, shot-firer and/or person carrying out the daily inspection. Other people potentially working on or near edges are surveyors, engineers, explosives truck workers, planners, geologists, geotechnical engineers and fencers.

A hierarchy of control is:

- > a windrow, a fence or other physical barrier capable of supporting a person's weight if they fall against it should be in place along the edge (refer to Figure 104).
- > if a barrier is not practicable, you should determine a distance from the edge that is safe to work and demarcate this area with a fence (i.e. para-webbing fence or waratah wire type fencing). The safe distance should be a minimum of two metres (refer to Figure 105).

When installing or removing any barrier other than a windrow, provide a travel restraint system such as a harness. Connect this harness to a fixed position that restricts workers' ability to work outside the safe area (refer to Figure 106).

A risk assessment should be carried out to establish a safe system of work for any person likely to be in a position where they may fall from a face. Consider the geology and stability of the face, the ground conditions, weather, lighting equipment being used, the need to adjust burdens, marking hold positions and profiling.

Windrows are preferable to other less substantial barriers but may hide cracks or signs of instability along the edge. Windrows should be:

- > constructed only after inspection of the area below. Faces need to be inspected for faults, change in appearance, loose surface, evidence of falling rocks, water seepage, joints and cracks
- > constructed a metre or two from the edge where possible so any cracks or deterioration of the edge can be seen
- > constructed from suitable material to avoid trip hazards
- > a minimum height of one metre (for pedestrian protection only)
- > regularly inspected and maintained.

Workers should be trained in the appropriate selection and use of harnesses before starting work. Make sure workers are closely supervised until assessed as competent.

Mobile plant should not be parked under high walls due to the hazard of rock falls.

The use of safety barriers or windrows should be considered where necessary to establish exclusion zones.

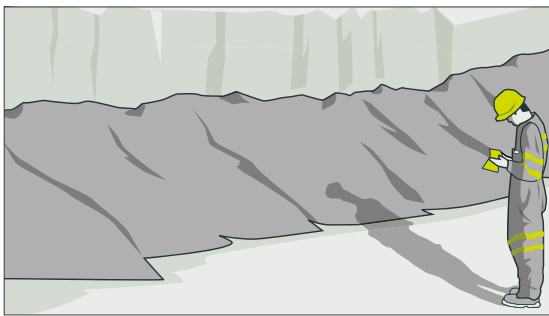

Figure 104. Example of a pedestrian windrow



Figure 105. Example of non-weight supportive barriers

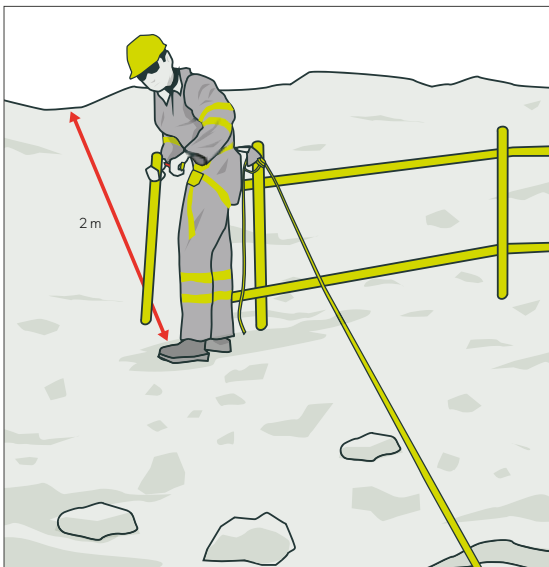

Figure 106. Example of fall restraint system

17

PART D

Maintenance and repairs

IN THIS SECTION:

- 17.1 Common hazards when undertaking maintenance
- 17.2 Isolation and lockout of energy
- 17.3 Permit to work systems
- 17.4 Inspecting and servicing mobile plant
- 17.5 Blocked crushers or hoppers
- 17.6 Pugmill mixers

Tasks such as maintenance, repairs, servicing, clearing blockages and cleaning can be dangerous. Workers can be fatally or seriously injured if they don't manage the risks carefully.

This section describes how to:

- > identify and manage common hazards including falls, energy sources, confined spaces and equipment for welding or cutting
- > isolate equipment and use safe lockout and permit procedures to keep workers safe
- > inspect and service mobile plant safely
- > prevent and clear blockages in crushers or hoppers.

A maintenance and inspection program is critical to ensure equipment and machinery is safe to use. Maintenance should be considered when developing control measures included in the mine's mechanical engineering control plan and electrical engineering plan. Maintenance and inspection programs should consider the operational environment the machinery or mobile plant are being used in, particularly when subject to corrosion or wear.

Maintenance, inspection and testing must be carried out:

- a) in accordance with the manufacturer's recommendations, if any
 - b) if there are no manufacturer's recommendations, in accordance with the recommendations of a competent person
 - c) in relation to inspection, if it is not reasonably practicable to comply with (a) or (b) above, annually.
- (clause 213 WHS Regulation)

Maintenance and inspection programmes should take into account the full scope of the installation and operation of machinery or mobile plant including, as appropriate:

- > the structure of the machinery (bracing, supports)
- > safety features (i.e. emergency stops, guarding, emergency equipment, props)
- > integrity of walkways, stairs, ladders, railings or guardrails
- > integrity of holding vessels (i.e. tanks, bins, hoppers and chutes)
- > integrity of lifting equipment (i.e. chains, slings, straps, hooks, gantry cranes, lifting eyes, quick hitches, fall arrest anchors)
- > signage and other warning devices (i.e. lights, alarms).

Maintenance and inspection programmes should consider the full scope of the installation and operation of machinery or mobile plant including, as appropriate:

- > the structure of the machinery (bracing, supports)
- > safety features (i.e. emergency stops, guarding, emergency equipment, props)
- > integrity of walkways, stairs, ladders, railings or guardrails

- > integrity of holding vessels (i.e. tanks, bins, hoppers and chutes)
- > integrity of lifting equipment (i.e. chains, slings, straps, hooks, gantry cranes, lifting eyes, quick hitches, fall arrest anchors)
- > signs and other warning devices (e.g. lights or alarms).

Mine operators should ensure a competent person examines any machinery that has been stopped for the preceding 24 hours or longer before it is started. Best practice is for a driver to do a shift pre-use inspection before using the vehicle.

In addition, the operator of a mine must ensure that arrangements are in place for the regular inspection of the working environment of the mine for the purposes of the WHS laws.

The mine operator should ensure a competent person examines every accessible area of the site. Include every area containing barriers, machinery and surface infrastructure at least weekly and every area where a worker is or will be before every shift and during shifts as required. The arrangements for inspection must be included in the safety management system and clearly detail:

- > the procedures for conducting inspections
- > when inspections are to be carried out
- > who is competent to conduct inspections
- > the number of competent people required to conduct each inspection.

Persons working on registered vehicles are required to hold a current Tradesperson's Certificate in accordance with the Motor Dealers and Repairers Act 2013.

For more detailed information on inspection and maintenance of machinery, including safe systems of work, see the *Mechanical engineering control plan code of practice* and MDG 15 *Mobile and transportable plant for use in mines and petroleum Sites*.

17.1 COMMON HAZARDS WHEN UNDERTAKING MAINTENANCE

Undertaking maintenance activities (including cleaning) can potentially expose workers (and others) to significant hazards. The following hazards should be considered in the site safety management system.

17.1.1 WORKING AT HEIGHT

Maintenance work often involves using access equipment to reach raised sections of machinery or mobile plant. Eliminating the need to access machinery or mobile plant at height by careful design is the most effective control.

Where elimination is not practicable and frequent access is required, platforms, walkways, stairways and stairs/ladders that comply with AS 1657 (and, as may be applicable, the building code) should be provided.

Where infrequent access is required suitable temporary access equipment with adequate barriers or fall arrest systems should be used. Where practical the worker should work in fall restraint or limited free fall at all times. Free fall is limited to 600mm.

Where this is not practical and persons are required to work in fall arrest system, there should be at least one other person on the site who can rescue them if they fall. When using a fall arrest system there should be sufficient distance between the work surface and any surface below to enable the system to fully deploy.

For more detailed information on platforms, walkways, stairways and ladders see AS 1657 *Fixed platforms, walkways, stairways and ladders – Design, construction and installation*.

For more information on preventing falls from height see section 16 and *Managing the risk of falls at workplaces code of practice*.

The use of elevating work platforms (EWP) has reduced the risk of falls but involves other risks such as a risk of crush injuries or death if the EWP collides with a fixed object. Secondary guarding should be considered if there is a potential for a crush injury to a fixed structure. These risks should be managed if the use of EWPs is being considered to manage the risks of falls from heights. See Resources Regulator Safety Bulletin SB15 – 04 for more information.

17.1.2 FALLS OF HEAVY ITEMS

Heavy items may need to be moved, or be disturbed, during maintenance work.

If one of these heavy items fall, injuries or fatalities can occur. Incidents can include:

- > the failure of lifting equipment
- > inappropriate lifting and slinging practices
- > inadequate supports or supports not resting on level or firm ground
- > incorrectly estimating the weight or centre of gravity of the load
- > rocks falling from trap points on mobile plant or the headboards of haul trucks.

The people responsible for the maintenance work shouldn't presume that things will be okay, that others will know what to do, or the right equipment will necessarily be available.

If a heavy item must be moved or temporarily supported during maintenance work, it is crucial the risks are assessed and action is properly planned, developed and communicated.

These lifts, or the use of temporary supports, may be one offs and will inevitably require more knowledge and skill than routine production and maintenance tasks.

Make sure:

- > everyone involved in maintenance understands the risks
- > an assessment of the risks (including the risk of disturbing something inadvertently) is completed and a plan of action decided on before a heavy item is moved or temporarily supported
- > there is someone competent to provide advice on safe slinging and on safe working practices for work involving heavy loads
- > any equipment used to lift or support a heavy load is suitable and, where necessary, has been inspected and tested by a competent person
- > heavy items are not left unsecured where they may tip over, fall or slip and no-one works under suspended loads
- > All lift points are suitably rated and certified
- > equipment is thoroughly cleaned with any loose material removed before maintenance activities commence.



17.1.3 ENERGY SOURCES OR STORED ENERGY

Isolation, lock out arrangements and, in some cases, permits to work are essential to enable maintenance work to be conducted safely.

Before any maintenance work is undertaken:

- > identify all power or energy sources
- > isolate the power or energy source
- > apply an isolation device (padlock) and a sign (or tag) to indicate that maintenance work is in progress
- > dissipate any stored energy (e.g. hydraulic or pneumatic power)
- > test and verify isolation is correctly applied. For more detailed information on isolation systems, see section 17.2.

17.1.4 CONFINED SPACE ENTRY

Confined spaces pose dangers because they are usually not designed to be areas where people work. Confined spaces often have poor ventilation which allows hazardous atmospheres to quickly develop, especially if the space is small. The hazards are not always obvious and may change from one entry into the confined space to the next.

The risks of working in confined spaces include:

- > loss of consciousness, impairment, injury or death due to the immediate effects of airborne contaminants
- > fire or explosion from the ignition of flammable contaminants
- > difficulty rescuing and treating an injured or unconscious person
- > asphyxiation resulting from oxygen deficiency or immersion in a free-flowing material, such as grain, sand, fertiliser, water or other liquids.

A confined space is determined by the hazards associated with a set of specific circumstances and not just because work is performed in a small space.

A confined space means an enclosed or partially enclosed space that:

- > is not designed or intended primarily to be occupied by a person; and
- > is, or is designed or intended to be, at normal atmospheric pressure while any person is in the space; and
- > is or is likely to be a risk to health and safety from: an atmosphere that does not have a safe oxygen level, or
- > contaminants, including airborne gases, vapours and dusts, that may cause injury from fire or explosion, or
- > harmful concentrations of any airborne contaminants, or
- > engulfment.

Confined spaces are commonly found in vats, tanks, pits, pipes, ducts, flues, chimneys, silos, containers, pressure vessels, underground sewers, wet or dry wells, shafts, trenches, tunnels or other similar enclosed or partially enclosed structures, when these examples meet the definition of a confined space in the WHS Regulations.

A confined space does not include a mine shaft or the workings of a mine.

Refer to Figure 107 – How to determine a confined space.

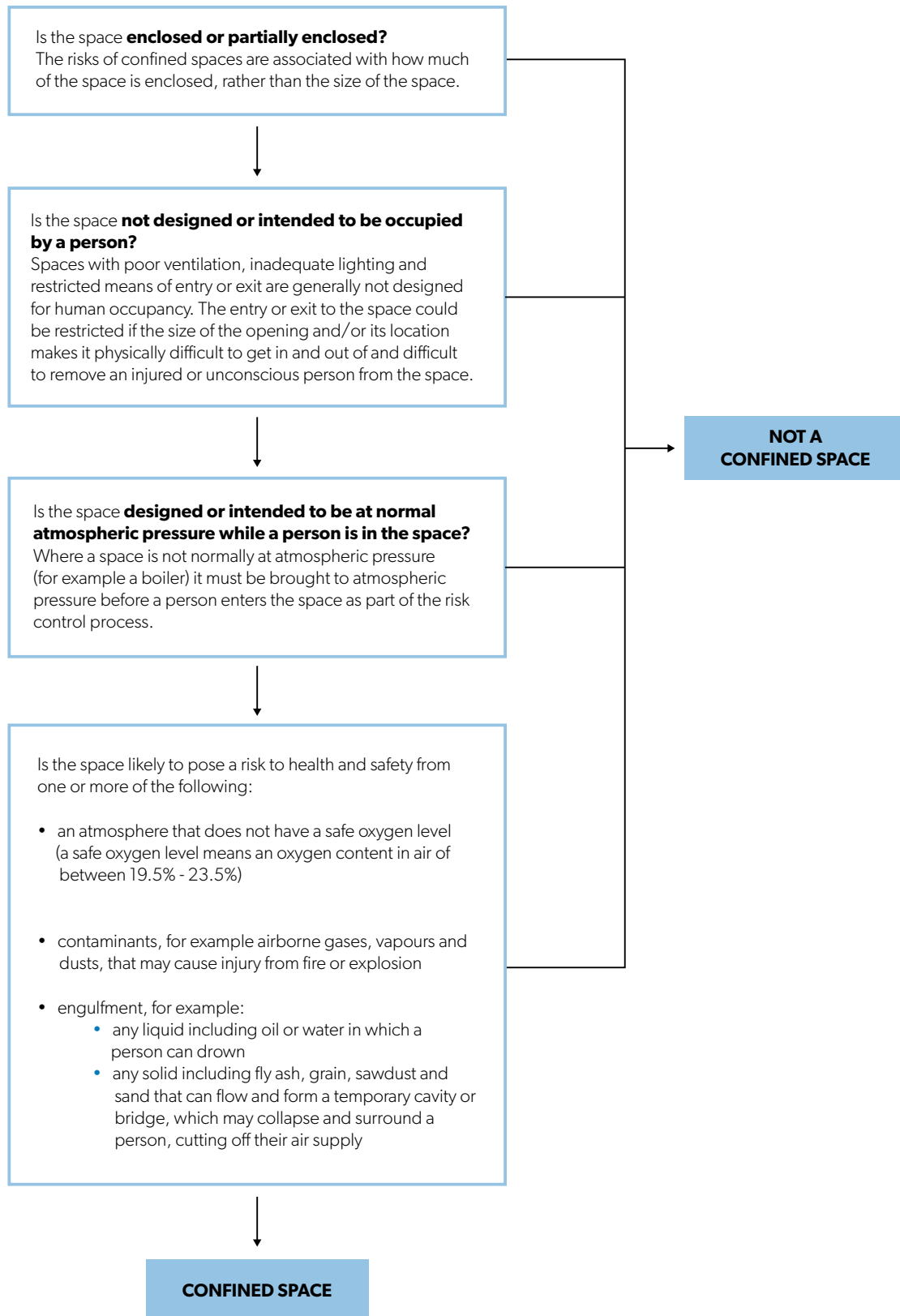

Figure 107. How to determine a confined space

Entry and exit to a confined space: The following shall be completed when entering and exiting a confined space:

- > A safe level of oxygen is present (19.5% - 23.5%)
- > Atmospheric testing is to be conducted prior to entry of the confined space and as required during the task as per the outcomes of a risk assessment. Refer to table 2 for atmospheric hazard management.
- > A safe means of access is established into the confined space which is large enough to allow people wearing the necessary protective clothing and equipment to enter and exit
- > Concentrations of flammable contaminants are below 5% of its Lower Explosive Limits.
- > A confined space entry permit has been completed.

At most mines, areas that may be confined spaces include tanks, load-out bins, reclaim tunnels, crushers/screens, conveyor transfer chutes and poorly ventilated rooms (e.g. cable galleries under switch rooms).

All confined spaces on sites must be identified in a register and suitably labelled as confined spaces.

There are specific provisions in the WHS Regulation for managing the risks of confined spaces including permits and emergency response. See the *Confined spaces code of practice* for details of the requirements and how to manage the risks they pose.

17.1.5 WELDING AND GAS CUTTING

Welding can potentially cause acute, chronic and long-term hazards to worker health and safety. These can act quickly or may present only in the long term.

The NSW WorkCover *Welding processes code of practice* provides guidance on welding. The Welding Technology Institute of Australia (WTIA) *Health and Safety in Welding 2013 – Technical Note 7 (TN7)* provides guidance on health and safety in welding.

Welding hazards include:

Fires and explosions: These are an ever-present hazard with many welding processes.

Burns: Welding causes items to become hot, creating a risk of burns and fires from hot metal and welding spatter.

Fumes: Fumes generated by different welding processes may range from being of nuisance value to highly toxic. Health effects can occur very soon after exposure (e.g. exposure to cadmium fumes can be fatal within hours) or may not result until after many years. Fume control requires appropriate ventilation equipment and may require advice from a specialist.

Electric shock: Welding processes that use electricity pose both obvious and subtle hazards of electric shock – which can be fatal. Take standard precautions, as explained in the *Welding processes code of practice*, when using welding equipment. Expert assistance can be needed in some circumstances to identify subtle hazards. Electric shocks should not be considered a normal occurrence in welding. A welding operator should suffer no electric shocks during the normal course of welding.

Appropriate equipment selection, set-up and maintenance is important and may require specialist advice to ensure safety.

Compressed gases: Compressed gases in cylinders pose several hazards. Safe use methods are outlined in TN7 section 5.

Hazardous substances: Hazardous substances used during some welding processes can require highly specialised methods of control (e.g. extremely toxic hydrofluoric acid). Use a specialist in these situations.

Toxic gases: Precautions for preventing toxic gases from causing harm are outlined in TN7 sections 5 and 10. Toxic gases may be:

- > used in or generated by the process (e.g. acetylene, ozone, nitrogen oxides, carbon monoxide)
- > generated when coatings on metal surfaces are heated (e.g. galvanised steel, epoxy resins, degreasing agents, paint)
- > generated when the arc flash and some degreasing chemicals or paints react (e.g. phosgene or phosphine).

Suffocation: Inert gases used during welding can flood an area and lower its oxygen content, especially in confined spaces. Suffocation can result. For more detailed information on confined space entry see section 17.1.4.

Radiation: Arc flash is a well-known hazard when welding. Standard precautions (PPE) should be used to prevent eye and skin exposure – for the worker and others in the vicinity. Reflecting surfaces make exposure to radiation more likely. For more information on PPE requirements see *Health and Safety in Welding*.

Heat stress: Working for long periods in hot environments can lead to distress and, in an extreme case, fatal heat stroke. Specialist advice should be sought if welders work in hot environments. The main control measures are good ventilation, drinking cool water and rest breaks. For more information on heat stress, see section 15.6.

Dust: Associated processes (grinding) may generate hazardous levels of dust. For more information on dust see section 15.5.

Noise and vibration: Noise and vibration levels during some welding processes can be high and should be controlled or appropriate hearing protection should be worn. For more information on noise and vibration see sections 15.3 and 15.4.

Stored energy: Some workpieces contain stored energy such as wear plates that can spring up when being removed. Confirmation that the stored energy has been controlled is required before conducting any activity.

Damage or fire from hot work activities: Fires or damage to other plant can occur both adjacent to hot work activities if a suitable barrier has not been put in place. Assessments of hazards both adjacent to and below needs to be conducted prior to hot work activities. Note molten metals have temperatures exceeding 1500°C and a hard barrier should be used wherever practical. If a blanket is used it should be suitably rated for this temperature.

Manual handling: Some welding processes may involve heavy or repetitive handling. For more detailed information on manual handling see section 15.7.

Allied processes:

Several processes are discussed in TN7:

- > plasma cutting
- > brazing and soldering
- > thermal lancing.

Providing health and safety information and advice on welding and cutting processes can be complex. There are many subtleties and traps for the unwary or inexperienced. Specialist advice may be required.

17.2 ISOLATION AND LOCK-OUT OF ENERGY

Energy isolation is much more than putting a lock and tag on a switch. To effectively isolate workers from energy, you need to know what energy is, and how it can be safely isolated on specific machinery and mobile plant.

17.2.1 LOCK-OUT AND TAG-OUT SYSTEMS

Lock-out and tag-out (LOTO) systems are the placement of a lock and tag on an energy-isolating device once isolation has been done. They indicate that the energy-isolated device is not to be operated until removal of the lock and tag in accordance with an established procedure.

Lock-out is the isolation of energy from the system (a machine, equipment or process) that physically locks the system in a safe mode. The locking device (or lock-out device) can be any device that can secure the energy-isolating device in a safe position (i.e. lock and hasp or lockable switch).

Lock out devices on Diesel powered plant should be installed in accordance with AS/NZS 4871.6 *Electrical Equipment for Mines and Quarries*.

Tag-out is the labelling process that is used when lock-out is required. The process of tagging out a system involves attaching or using an indicator (usually a standardised label) that includes the following information:

- > Why the lockout and tag out is required (e.g. repair or maintenance).
- > The date and time the lock and tag was attached.
- > The name of the authorised person who attached the lock and tag to the system. Only the authorised person who put the lock and tag onto the system is authorised to remove them. This procedure helps to ensure the system or equipment cannot be started without the authorised person's knowledge.

Once an item of plant or equipment has been isolated, the form of isolation must be tested for effectiveness (i.e. try and test start the item) and any residual energy must be dissipated. This process may include:

- > blocking or supporting a movable item so it cannot fall or move under gravity
- > bleeding residual pressure from compressed air or pressurised fluid systems
- > removal of burden or load (e.g. bulk materials in chutes/hoppers)
- > In the latter case, it may be prudent to run-out materials from the section of plant before the isolation process.

WHY LOCK-OUT AND TAG-OUT ARE IMPORTANT

Safety devices such as guards or guarding devices are installed on systems to maintain worker safety while these systems are being operated. When performing non-routine activities, these safety devices may be removed but there must be alternative methods in place to protect workers from the increased risk of injury of exposure to the accidental release of energy. Non-routine activities include maintenance, repair, set-up or the removal of jams or misaligned feeds.

The main method used and recommended to protect workers from risk of harm in these cases is the use of a lock-out and tag-out procedure (LOTO).

A LOTO procedure will prevent:

- > contact with a hazard while performing tasks that require removal, by-pass or deactivation of safe guarding devices
- > unintended release of hazardous energy (stored energy)
- > unintended start-up or motion of machinery, equipment or processes.

LOCK-OUT PROCEDURES AND WORK INSTRUCTIONS

The written lock-out procedure should identify:

- > the plant or equipment that needs to be isolated
- > when it needs to be done
- > where the isolation is to be done
- > the tools available to do it
- > who is supposed to do it
- > who needs to be notified.

Work instructions on how the lock-out process is to be carried out should be by a step-by-step process including how stored energy is controlled and de-energised, how isolation can be verified and how and where lockout devices are installed. Work instructions should be machine, equipment or process specific and include pictures or images of what is being described.

For more information on lock-out systems and isolation procedures, including responsibilities, see the Mechanical engineering control plan code of practice and MDG 15 *Mobile and transportable plant for use on mines and petroleum sites*.

17.3 PERMIT TO WORK SYSTEMS

A permit to work (PTW) system is a formal documented process used to manage work identified as significantly hazardous by making sure all safety measures are in place before work starts.

A PTW system is also a way to communicate between site management, plant supervisors, operators and those who carry out the hazardous work (which may often include contractors or other specialists). Essential features of a PTW system are:

- > clear identification of who may authorise particular jobs (and any limits to their authority) and who is responsible for specifying the necessary precautions
- > training and instruction in the issue, use and closure of permits
- > monitoring and auditing to make sure the system works as intended
- > clear identification of the types of work considered hazardous
- > clear and standardised identification of tasks, risk assessments, permitted task duration and supplemental or simultaneous activity and control measures
- > clear job close-out and return to normal service procedures.

The terms permit to work, permit or work permit refer to the paper or electronic certificate or form used to authorise certain people to carry out specific work at a specific site at a certain time. It also sets out the main precautions needed to complete the job safely.

17.3.1 WHEN ARE PERMIT-TO-WORK SYSTEMS REQUIRED?

Consider permit to work systems whenever the intention is to carry out particularly hazardous work. PTW systems should not be applied to all activities as experience has shown their overall effectiveness may be weakened if over used.

Permits to work are not normally required for controlling general visitors to site or routine maintenance tasks in non-hazardous areas. Permit to work systems are normally considered most appropriate to:

- > non-production work (i.e. intrusive maintenance, repair, inspection, testing, alteration, construction, dismantling, adaption, modification or cleaning)
- > non-routine operations
- > jobs where two or more individuals or groups need to co-ordinate activities to complete the job safely
- > jobs where there is a transfer of work and responsibilities from one group to another (e.g. shift changeovers or multi-disciplinary/complex tasks).

More specifically, the following are examples of types of jobs where permits could be considered:

- > hot work (e.g. welding, flame cutting, grinding in plant or process areas) and work that may generate sparks or other sources of ignition where there are fuel sources or other potentially flammable materials (e.g. rubber belting, certain wear linings in chutes/hoppers)
- > work that may involve breaking containment of a flammable, toxic or other dangerous substance or pressure system, and work involving the use of hazardous or dangerous substances, including explosives
- > work on electrical equipment or other equipment that may give rise to danger
- > entry and work within confined spaces
- > pressure testing
- > work affecting evacuation, escape or rescue systems
- > work at height
- > drilling, trenching or excavating
- > any other potentially high-risk operation.

17.4 INSPECTING AND SERVICING MOBILE PLANT

Mobile plant work in harsh environments and require effective maintenance to avoid developing defects. Establish a program of daily visual checks (or pre-start checks), regular inspections and servicing to schedules according to the original vehicle manufacturer's instructions and the risks associated with the use of each vehicle.

Inspections and maintenance should include, where appropriate:

Vehicle Control

- > braking systems
- > steering
- > tyres, including condition and pressures
- > safety devices such as interlocks.

Driver Safety

- > seats and seat belts
- > mirrors, cameras and other visibility aids
- > lights and indicators
- > warning signals

- > air-conditioning/heating systems
- > windscreen washers and wipers
- > firefighting equipment.

Vehicle Maintenance

- > condition of cab protection devices (such as ROPS and FOPS)
- > condition of tailgates
- > worn, loose or missing components
- > damage/structural integrity
- > leaks
- > condition of hydraulic pipes and hoses
- > fluid levels
- > functional checks on the vehicle
- > access systems, guard rails and non-slip surfaces
- > engine bay/exhaust free from combustibles

Where mobile plant is hired, determine who is responsible for maintenance and inspection during the hire period and make this clear to all parties.

Put in place a safe system of work that addresses issues such as safely blocking the vehicle and its attachments, isolating stored energy (e.g. gravity) and preventing the vehicle from inadvertently being started. When using jacks, they should be rested upon suitable load bearing substrata. Raised objects should be lowered wherever practicable (e.g. excavator or loader implements).

Determine a procedure to address defects where they are found in mobile plant or attachments. Such procedures could include:

- > recording defects when completing daily visual checklists (pre-start inspections), scheduled inspections and maintenance logs
- > establishing protocols for safety critical defects (when a vehicle should be removed from operation, time frames to fix specific defects and so on). For example, how deep does a cut in the tyre need to be before they should be replaced?
- > a system to isolate mobile plant (removal from service) when safety critical defects are found. For example, keys or other starting devices removed and secured until repairs are started and attachment of out-of-service tags.

MAINTENANCE UNDER HYDRAULICALLY RAISED PARTS OF MOBILE PLANT

Many mobile plant use hydraulics to raise, lift or move material or parts of the vehicle (e.g. truck trays, front-end loader buckets, excavator booms and drilling rigs). These raised parts have stored energy and you should provide physical supports or other devices to prevent raised parts dropping or being lowered while workers are under them.

Consider:

- > removing the elevated part before other maintenance work takes place (eliminate the hazard)
- > fitting a restraining system to the elevated part
- > fitting the tray or bucket with a built-in prop
- > ensuring restraining system controls are clearly marked and shrouded or protected from accidental operation
- > fitting hydraulic cylinders with over centre valves.

Rear dump trucks are to be provided with a means of restraining the dump body when in the raised position for inspection or maintenance.

The means of restraint can consist of pins or slings or similar and have a minimum safety factor of 4 to 1 when applied to maximum possible down load which can be exerted on the dump body when the body is in the raised position except where a load lock type device is fitted on the body lift cylinders in which case a minimum factor of safety of 2:1 applies.

BRAKE TESTING

A suitable inspection scheme should be in place to ensure brakes are always in good condition. This is often combined with other maintenance work. Electronic brake testing equipment should be used on a regular basis to accurately measure brake performance. This will show deficiencies in the brake system before they become a problem. The Mechanical engineering control plan should require operation, monitoring and maintenance of brake systems according to original vehicle manufacturer (OVM or OEM) recommendations, as a minimum.

It should be ensured that:

- > the driver tests the brakes at the start of every shift (pre-start inspection), including the park brake and foot brake
- > the condition of brake system components is monitored according to OVMs/OEMs recommendations, reducing the likelihood of catastrophic failure and ensuring they continue to function as intended
- > brake system performance is tested according to OVMs/OEMs recommendations in both static and dynamic situations
- > drivers and maintenance workers can access OVMs/OEMs operating and maintenance manuals at site as appropriate
- > braking system repair, monitoring, inspection and testing records are readily available at site
- > drivers and maintenance workers are trained in the relevant aspects of braking systems
- > safety critical aspects of vehicle operation, including emergency braking systems, retarders and other controls available in the event of engine failure. For example, accumulators are incorporated into driver training and assessment processes, with appropriate input from competent maintenance workers
- > operating and brake maintenance practices for contractors' mobile plant are not inferior to the vehicle maintenance practices adopted by site
- > contractors' mobile plant is not allowed to operate on site unless maintenance and testing records are checked to verify the integrity of brake systems
- > brake maintenance, including processes used for contractors' mobile plant, is regularly audited for effectiveness

- > if OVM/OEM manuals are unavailable (e.g. due to the age of vehicle), prepare bespoke manuals, so effective brake system operation and maintenance strategies can be established. Use people with appropriate skills and technical expertise to facilitate the process.

Correct brake system functioning depends on the condition of system components, which in turn depends on the quality of the maintenance. Any brake system maintenance strategy should focus on detecting and rectifying a defect before it results in a loss of brake function.

Brake system maintenance strategies should initially be based on the original vehicle manufacturer (OVM/OEM) recommended maintenance programs and on condition monitoring, inspection and testing schedules.

OVM/OEM stipulated operating procedures and repair techniques help make sure brake system integrity is not compromised. The OVM/OEM information should be stored, maintained, updated and be readily accessible by relevant workers, whether it is in hard copy, electronic copy or online based systems.

Hazard identification and risk assessment aimed at improving brake system reliability should consider anything that could affect the safe operation of mobile plant. This could include site conditions, maximum loads, operating speeds, operating grades, effects of heat fade, component failure and loss of pressure.

Controls may include more frequent component inspections for wear or damage and regular brake performance verification techniques. These could include dynamic brake testing (DBT), electronic brake test equipment and thermographic temperature profiling, to detect poor performance.

(Note: a positive DBT result doesn't necessarily verify brake system integrity or confirm the system has been maintained to OVM/OEM recommendations. It only indicates the brakes were effective at the time of testing).

In introducing DBT, the risk assessment to determine appropriate controls should consider, but not be limited to:

- > OVM/OEM consultation on any deviations from the stated recommendations
- > applying relevant brake performance testing standards or appropriate industry practice
- > site facilities and limitations relating to surface, space and controlling mobile plant in case of brake failure during testing
- > variations in test methodology and acceptance criteria for different vehicle types and categories (for more detailed information see AS 2958.1-1995 *Earthmoving machinery – Safety – wheeled machines – brakes*)
- > the reliability of the DBT test instruments
- > applicability and integrity of the standards, procedures and methods used to interpret the results
- > the training and competency of workers conducting the tests.

Industrial trucks and load shifting equipment (forklifts, mobile cranes) with inherent instability and lack of traction, particularly on ramps and slopes, present a challenging risk management task. Operators should understand the brake system design limitations and that brake system monitoring, inspection, testing and maintenance are appropriate for the risks in certain applications.

The Australian Standard AS 2359.13-2005 *Powered industrial trucks – brake performance and component strength* provides guidance on methods for assessing and testing the performance and components of brakes fitted to industrial trucks with rated capacities up to and including 50 tonnes.

Safe forklift operation on gradients largely depends on the type, size and design of the forklift. Ask the OVM/OEM if you are unsure of the braking system's performance capabilities. See *SafeWork Australia's General guide for industrial lift trucks for more information*. SafeWork Australia and SafeWork NSW have a range of guidance materials, including short videos on forklifts, to assist both PCBUs, operators and pedestrians.



17.4.1 TYRE ASSEMBLY SAFETY

Working with tyre assemblies is potentially dangerous because of their size, mass, complexity of multi-piece wheels and rims, magnitude of air or gas pressure, the uncontrolled release of stored energy and the presence of combustible materials.

This section describes the common hazards when working with tyres, rims, wheels and assemblies and the types of controls expected during their life cycle. It provides guidance on safe systems of work, while allowing for flexibility in both process and documentation.

Operators should adopt a risk management approach to develop a documented tyre management plan that is current and specific to site, with appropriate controls to manage the risks. Four main elements should be considered:

- > competent people
- > safe systems of work
- > fit-for-purpose equipment
- > a safe and controlled working environment.

(Note: in this guideline the term tyre assembly refers to tyres, rims and wheel assemblies.)

TYRE RISK MANAGEMENT AND LIFECYCLE MANAGEMENT

Tyre assemblies are safety-critical components that should be selected, operated and maintained correctly to reduce the risk of workers' exposure to associated hazards to as low as reasonably practicable. The lifecycle management of tyres should clearly define the selection, procurement, operation, maintenance and disposal.

The management of these items requires a risk assessment in consultation with the correct people. This can include but not limited to tyre, wheel and rim manufactures, mine designer, plant original equipment manufacturers, operators, tyre, wheel and rim technicians and maintainers.

The assessment should include:

- > Application, earthmoving equipment, light vehicles, fixed plant etc.
- > Type of rim, multi-piece, divided (two piece or split rim), single piece or drop centre
- > Mounting, will it be cleat mounted or disc mounted.
- > Tread type required, lugs or smooth (off road on road)
- > Is the tyre pneumatic or is there a requirement for solid fill or solid tyres?
- > TKPH (earthmoving) or duty cycle required
- > Handling and working with tyres
- > Tyre fires, burst and explosions
- > Loss of control of vehicle due to tyre failure
- > Sudden release of stored pressure energy
- > Compressed air or gas
- > Noise
- > Handling heavy objects
- > Operating conditions
- > Working with or operating heavy equipment

- > Heat and fire
- > Fuels and chemicals
- > Pyrolysis or diffusion
- > Other hazardous conditions
- > Emergency response to hazardous conditions
- > Exclusion zones and times around hazardous tyres
- > Inflation and deflation of tyres
- > Fire fighting
- > What constitutes a worn-out component
- > Integrity of components use of technology to monitor tyre temperatures and pressures
- > Re-treading of tyres
- > Review of legislation, relevant standards, guidelines and incidents and the,
- > Competency of workers maintaining and changing tyre assemblies.

SELECTION OF TYRE AND RIMS

Tyres and rims shall be selected by a competent person based on the tyre manufactures and equipment manufacturers recommendations, taking into consideration a minimum of the following points:

- > Tyre load and speed
- > Tonne, Kilometre Per Hour rating or duty cycle required
- > Conditions of operation
- > Type of equipment being used on
- > Will the rim be a multi piece, single piece of drop centre?
- > Mounting and dismounting
- > Requirement for solid fill or solid tyres.

Other considerations should include any special tooling requirements and the competency of workers.

Split wheel rims should not be used unless there is an effective means to prevent disassembly when the rim/tyre is attached to the mobile plant. Appropriately documented procedures with fit-for-purpose equipment should be used when carrying out maintenance or service activities. Fatalities have occurred while carrying out maintenance and service activities involving split rims.

Refer to AS 4457.1, AS 4457.2, AS/NZS 2230, ISO 4250-1, ISO 4250-2, ISO 4250-3, ADR 42/04 and SafeWork Australia document Guide for split rims for further guidance.

COMPRESSED AIR

Compressed air poses a significant risk to workers especially to their eyes both from high velocity air and from particles of dust, metal, oil and other debris, which can be propelled by the air.

Appropriate personal protective equipment (PPE) should be worn to protect workers from injury by high-velocity air jets, particles of dust, metal, oil and other debris that can be blown about by the air stream.

As a minimum eye protection should be worn at all times.



Overalls or other PPE may protect skin from light particles and debris, however fabric does not offer protection against high velocity air at close range. Particles can be blown through overalls and skin and penetrate the body. Compressed air jets can be blown into the body causing swelling and pain. Air can be carried to the small blood vessels of the brain, lungs or heart, resulting in serious injury or death.

Workers should never use compressed air to dust themselves down.

The stored potential energy in an inflated tyre, air receiver or other pressure vessels depends on the air volume and pressure and may be substantial. Tyre blast release significant energy. Overpressures caused by the incorrect inflation, overheating fire or pyrolysis increases the risk.

The force of a burst tyre can have enough energy to lift a small car up to eight metres into the air.

Compressors and air receivers should provide sufficient pressure and volume for tyres in use, routinely inspected and sited away from personnel and mobile equipment.

All other valves, air fittings and air lines fitted to the compressed air system shall be rated to withstand the highest air pressure the compressor can produce.

Compressors and associated equipment such as air-receivers should be regularly inspected in accordance with a schedule of planned maintenance to make sure they meet legal requirements and are safe to use.

All pressure gauges and control devices should be checked against a master pressure gauge at regular intervals or immediately after any heavy impact or other damage. Compressed air hand tools should be maintained and checked regularly.

Consideration should be given for an air dryer to minimise moisture entering tyre.

NITROGEN

Nitrogen gas is virtually inert, the correct use of nitrogen prevents pyrolysis by removing the oxygen content to below 5.5 percent by volume. Inflation of tyre with nitrogen reduces the potential for auto – ignition because there is insufficient oxygen to support combustion. Purging of tyre may be required to decrease the oxygen level to below 5.5 percent by volume.

The use of compressed nitrogen gas may also control risks such as rim rust, aging of the inner tyre and poor sealing.

The use of nitrogen gas can introduce additional hazards which need to be assessed as part of the site risk assessment including:

- > Another source of stored energy
- > Cryogenic hazard
- > Nitrogen acting as an asphyxiant in an enclosed or poorly vented workshop.

To avoid potential oxygen depletion, nitrogen should only be used in well ventilated areas.

MANUAL HANDLING OF HEAVY OBJECTS

The tyres and wheel assemblies of large mobile plant are usually too heavy to be manually handled safely.

The safe handling of many loads encountered in the fitting and maintenance of large earthmoving tyres and wheel assemblies can only be undertaken using specialist tyre handling equipment. Purpose designed tyre handling machinery, assembly jigs, inspection stands and other special attachments are required for moving the tyre casings, wheels and rims and tyre assembly.

The large dimension and weights of the tyre assembly or components present a potentially fatal crushing hazards if they fall or slip out of their restraints during transport, storage, handling assembly or fitment to tyre fitters and vehicle operators and need to be considered in site risk assessment with suitable controls put in place.

There are also potential fatal crush hazards associated with the support of equipment when the tyre assembly has been removed. The equipment should be position on level ground. Suitably rated and certified jacks and stands shall be used, and the supporting surface assessed by a competent person. Refer to AS3990, AS/NZS 2693, AS 2615 and AS/NZS 2538 for further guidance.

NOISE

Hearing damage can affect tyre fitters just as easily as other at-risk occupations. Causes of noise-induced hearing loss are compressed air blowing freely, noise from impact wrenches and wheel parts and tools dropping on concrete workshop floors. Engineering solutions to manage excessive noise are preferred over the reliance of PPE. The selection of air-tools for their noise-level characteristics should form part of the purchasing system.

Noise from steel impacting on concrete floors can be reduced with special floor surfaces or mats. Any residual noise must be dealt with by restricting the operator's exposure. Where noise exposure cannot practicably be further reduced, hearing protection must be provided, and its use must be enforced.

For more detailed information on noise management see the SafeWork NSW Managing noise and preventing hearing loss at the work place code of practice.

OPERATIONAL AND HAZARDOUS CONDITIONS MANAGEMENT

A number of hazardous conditions can be encountered when tyre assemblies are in operation. These need to be covered in the sites risks assessment and controls measures forming part of the sites tyre, wheel and rim management system.

Prior to loosening securing fasteners any tyre fitted to a wheel or rim assembly should be deflated to zero pressure and no greater than 5 PSI to allow handling of tyre assembly.

For dual assemblies specifically multi piece rims both tyres shall be deflated.

When removing fasteners, a sufficient number of fasteners are to be left in place to prevent uncontrolled movement of the assembly until the tyre assembly is held securely to allow safe removal.

The following table is not an exhaustive list of hazardous conditions that should be considered as part of the site risk assessment and tyre management system.

TYRE CONDITION	CAUSE
Bead bubbles	A visible bubbling where the wheel rim contacts the tyre bead
Bead erosions (steel exposed)	A visible erosion of the tyre bead exposing the steel internal tyre structure
Brake fire/hot brakes	Observation of visible smoke or flame emanating from the brake or wheel assembly
Contact with underground cables	An observation of physical contact between an underground electrical service and the mobile plant
Cracked rim base	A visible crack is observed in the rim base of the wheel assembly
Cracked side ring	A visible crack is observed in the side ring of the wheel assembly
Dragging brakes	A dry brake which is dragging is often felt during operation of the mobile plant or observed/heard during the rotation of the wheel assembly
Electrification	An observation of physical contact between an electrical service and the equipment and/or electrical arcing between the electrical service and the mobile plant.
Heat separation and belt edge separation	An observation of a horizontal opening in the tread lug is an indication of heat and belt edge separation. This event may produce a strong smell of burning rubber, but is not classified as a hot tyre event
Hot spots	Where a section of tread becomes detached and through continual operations creates friction and smoke. The smell of burning rubber can be detected
Hot tyre	An operational or mechanical occurrence in which the internal air pressure exceeds greater than 30% cold inflation pressure
Irregular tyre wear	An inconsistent level of wear over the tyre surface
Lightning strike	Observation or report is made of a lightning strike contacting the equipment
Missing wheel nuts	Wheel nuts are missing from the wheel assembly
Pyrolysis	Pyrolysis is the decomposition of carbonaceous material inside the tyre. Heating of the rubber (inner liner) releases gaseous volatile organic compounds into the air chamber of the tyre which can auto-ignite resulting in large catastrophic failures
Rock cut separation	A physical separation of the tread blocks from the tyre's casing or carcass
Rocks caught in dual wheel assembly	Rock(s) observed lodged between dual wheels of mobile plant
Side wall burst	A visual rupture in the tyre side wall that may lead to a complete tyre deflation
Side wall cuts and structural damage	Visual indication of physical cuts and signs of impact damage in the tyre side wall
Side wall deformation	A visual deformation or bulge is observed in the tyre wall structure
Side wall delamination	A visible delamination or peeling of the side wall surface
Smoke expelled from tyre	Observation of smoke emanating under pressure from the tyre and/or wheel assembly

TYRE CONDITION	CAUSE
Tread cuts	A physical cut or laceration in the tyre surface
Tread detachment	A physical detachment of tread from the tyre is observed
Tread separation	A physical separation of the tread blocks from the tyre is observed
Tread worn out	A significant reduction in tyre tread across the entire surface
Tyre burst	A visible outward rupture is observed in the structure
Tyre deflation during operation	A tyre that has fully deflated resulting in the base of the tyre having a significant flat surface where the wheel rim contacts the ground
Tyre explosion	Heat induced gas combustion inside the tyre
Tyre fire	Visible flame emanating from the tyre or wheel assembly
Tyre puncture	A visible deflation or loss of tyre pressure
Tyre valve missing	Tyre valve is visibly missing from the wheel assembly
Under inflated operational tyre	A tyre in operation that has been run at less than 70-80 per cent of the tyres cold inflation pressure

Table 11. Hazardous conditions that should be considered as part of tyre management system

Procedures should be put in place on what to do in the event of hazardous condition to include but not limited to:

- > Emergency management response
- > Firefighting equipment requirements
- > Exclusion zones
- > Stand down categories, response and times
- > Safe approach distances and direction for overheated or ignited tyres
- > Operator actions in the event of a hazardous condition
- > Post hazardous condition inspections
- > Training and rehearsing emergency events

For tyre fires, electrification, arcing or internal tyre fire the vehicle should be stopped in a safe area as soon as practical, operator evacuated, and area quarantined for 24 hours, an exclusion zone should be established up to 300 meters for large earth moving tyres with rims greater than 600mm and as per the sites risk assessment for smaller tyre assemblies.

Where equipment electrification is involved, the operator should remain in the cabin until advised by an electrician it is safe to exit.

Where the tyre has been run under inflated it shall be removed and inspected internally for damage as running at low pressure can cause fatigue loading in the tyre structure. If a tyre assembly is a dual, then both tyres should be inspected.

Tyre temperature and tyre monitoring system should also be considered.



MAINTENANCE AND DEFECT MANAGEMENT

Operators should be trained in recognition of tyre, wheel and rim hazards and their controls.

Pre-use inspection check sheets should be developed with guidance on what to look for and how to report defects.

During removal of wheel assembly if a defect is discovered the component should be removed from service and sent for testing or repairs as required. Unsafe, damaged or non-repairable components are to be permanently rendered unusable by cutting apart to prevent it being re-used.

All tyres, wheels and rims as minimum should be inspected and maintained in accordance with the manufacturers recommendations and the sites risk assessment.

All off-road vehicles should have a maintenance system in place for rims and wheels in accordance with AS 4457.1. to include inspections of the lock ring and O-ring grooves, gutter section, nave section and welds joining base components.

Only competent persons shall undertake inspections and repairs.

Adequate records of all inspection and repairs should be:

- > In accordance with AS 4457.1 as a minimum
- > Traceable to the individual serial number displayed on the wheel or rim base
- > Records should detail the nature of the repair, the repairer's organisation, date and NDT reports

The following should be considered when maintaining tyre assemblies:

- > Tyres, including small units, be inflated within a suitable restraint.
- > Tyres on split-rim and detachable-flange wheels be contained by a cage guard, or other suitable restraining device, when being inflated after being dismantled or repaired.
- > Tyres that have a large volume or are inflated to high pressures be contained by a cage guard or other restraining device such as a tyre fitting machine when being inflated after being repaired or otherwise removed from the wheel.
- > If restraints are not available, a suitable system of work is to be used (for example, inflating from behind a barrier or remote inflation or deflation).
- > Isolation of equipment to include tyre handler where applicable
- > Monitoring of tyre pressures

Refer to MDG 15 Mobile and transportable plant for use on mine and petroleum sites, WA Department of Mines and Petroleum- Guideline Tyre safety for earth-moving machinery on Western Australian mining operations and QLD Department of Natural Resources, Mines and Energy Recognised standard 13, Tyre, wheel and rim management for further guidance.

17.5 **BLOCKED CRUSHERS OR HOPPERS**

Clearing blocked crushers or hoppers can be very hazardous and many plant operators have been killed or seriously injured carrying out this task.

Blockage incidents can be greatly reduced by supplying material that is sized to match the feed opening. Preventing oversize feed material starts at the face with good fragmentation. Removing oversize material before delivery to the plant and vigilant control of the crusher feeder will make blockages less likely.

Causes of crusher blockages can be grouped under two main headings:

Stalling, due to:

- > electrical or mechanical failure
- > material jammed in the chamber causing an overload
- > overfeeding material
- > entry of tramp metal or wood
- > accumulation of material in the crash box
- > accumulation of fine material in the crusher discharge chute.

Bridging, due to:

- > oversized feed material
- > excessive clay or other fines in the crushing cavity, preventing small material passing through the crusher
- > a foreign body in the crusher feed or discharge chamber, obstructing the feed material.

17.5.1 PREVENTION

Every effort should be made to prevent oversize material or tramp metal entering the crusher feed hopper by:

- > designing any site blast to achieve optimum rock fragmentation
- > training and instructing the face operator not to load oversized material
- > using sizing bars or grids on crusher feeds
- > following the manufacturers (OEMs) recommendations on the rate, presentation of feed and crusher settings
- > instituting a program of good housekeeping to prevent scrap steel entering shovel buckets
- > ensuring the bucket size is appropriate to the capacity of the crusher
- > regular inspection of metal parts (e.g. bucket teeth, dumper wear plates and drilling components) to make sure they are unlikely to break off and enter the crusher feed
- > the strategic placing of electrical magnets or the installation of metal detectors to prevent tramp metal from entering the crusher
- > the use of level indicators for feed control
- > maintenance of drive systems
- > removal and adequate cleaning of the discharge chute.

A properly designed crushing operation should not need any person to be present on the crusher access/work platform during normal crushing operations.



17.5.2 CLEARING BLOCKAGES IN BRIDGED CRUSHERS

The preferred method of clearing a bridged crusher is by using a hydraulic arm with a breaker or pick attachment.

The hydraulic arm may be permanently mounted or an excavator fitted with a static pick or a hydraulic hammer. Where the arm is operated remotely (e.g. by radio control), closed circuit television (CCTV) is an invaluable tool in assisting the operator.

Depending on the risk assessment result, clearing out a bridging blockage with a hydraulic arm or similar may be carried out with or without the crusher still operating.

Prohibited zones should be established in case of fly-rock. When hydraulic arms are not available and it is necessary for a worker to enter the crusher to position hooks or slings, the crusher and feeder must be stopped, isolated and locked-out in accordance with the manufacturers (OEMs) or supplier's instructions and safe working practices (refer section 17.2).

Other options (which require more specialist expertise and competence) include: gas or chemical expansion and hydraulic ramp plates.

Other options considered should be subject to a detailed and thorough risk assessment. The crusher should be shut off and isolated before considering the use of bars and hand hammers. Bars should never be used on or near a crusher while it is running.

Consider the risk of large pieces of feed material moving and causing trap or crush injuries. Do not use wedges due to the risk of them becoming a projectile (this has caused fatalities in the past).

STALLED CRUSHERS

A stalled crusher should be treated as possibly being jammed with tramp metal or wood, which could be ejected with fatal consequences. Safe systems of work should be issued to plant operators detailing what to do in the event of a crusher stalling that should include:

- > clearing the area of all workers
- > notifying the site manager of the stalled crusher
- > isolating power to the crusher and associated plant
- > dissipation of residual stored energy
- > undertaking risk assessment for clearing the blockage
- > implementing hazard controls.

CLEARING BLOCKED CONE CRUSHERS

Many cone crushers are fitted (or can be retrofitted) with tramp metal hydraulic release systems or hydraulic assisted upper concave removal to prevent or eliminate hazards associated with blocked cone crushers.

For cone crushers that do not have these systems, follow the guidelines in sections 17.5.2 and above.

HAZARD OF ENTRAPMENT AT HOPPERS

There is the potential for an incident if anyone attempts to walk on the material that has been dumped into a hopper. The hazards are that they may be drawn into the feeding material or, if the material is hung up, they

may be drawn in when the material breaks free (which often may be sudden and significant). The material in the hopper may look solid but there may be a hidden void where it has bridged over the feeder. Anyone walking on the material is at risk of being engulfed if the bridged-over material collapses.

Mechanical devices should be provided (e.g. vibrators or air cannons) during normal operations so workers are not required to enter or work where they are exposed to entrapment by the caving or sliding of materials. Where people are required to enter or work near the hopper:

- > provide platforms or staging
- > stop supply and discharge of material
- > lock and tag-out equipment
- > implement working at height procedures as required.

17.6 PUGMILL MIXERS

Equipment for mixing crushed rock (road base) products, with or without additives (e.g. cement, fly-ash, lime, slag), is common in many extractive industry sites.

This equipment usually has a high connected power (electric or hydraulic motor drive), and generally has a twin-shaft counter-rotating horizontal paddle mixer chamber.

Numerous serious, often fatal, incidents have been recorded of workers becoming entangled in un-isolated pugmill mixing equipment. Often the equipment requires regular cleaning (e.g. after production runs of cement treated base or CTB) that introduces additional risk.

Specific access protocols and operating procedures (SOPs or SWMSs) should be developed, tested and deployed when such equipment is introduced to a site. All relevant operators and maintenance workers should be trained and instructed in these procedures.

Many pugmill manufacturers will have pre-installed safety interlock devices fitted to restrict access to the mixing chamber during operation. These safety interlocks must be regularly inspected and tested for effectiveness and must never be bypassed or defeated. Using a captive key system can be a very effective means of ensuring protection and interlocking systems are not defeated.

FLUID POWER SYSTEMS

The person with management or control of powered mobile plant at a workplace must in accordance with Part 3.1, manage risks to health and safety associated with the following:

- e) mechanical failure of pressurised elements of plant that may release fluids that pose a risk to health and safety.

(Clause 214 WHS Regulation)

Personal protective equipment (PPE)

Prior to working on fluid power systems, you should ensure you have all the correct personal protective equipment (PPE) required to do the task safely. This may include the following:

- > gloves, if required
- > safety helmet
- > safety boots

- > safety attire
- > safety glasses
- > hearing protection

Remember: Personnel protective equipment may not protect against fluid injection – for example, high pressure (725 PSI – 50 Bar) will penetrate most gloves.

Oil temperature is normally in the vicinity of 60°C depending on the system design.

Some applications often operate at temperatures much hotter than this, sometimes approaching the boiling point of water. Oil burns are painful, serious, and long lasting.

Personal Safety

Before working on any hydraulic circuit always assess the task you are going to do for potential hazards. Isolate all energy sources and bleed off any residual pressure that may be in the system and never:

- > Use part of the hydraulic circuit for any task for which it was not intended
- > Vent hydraulic fluid to atmosphere unless safely controlled
- > Disconnect any line that had not been de-energised and tested for de-energisation.

Hydraulic fluids such as oils, phosphate esters and other fluids can cause injuries to health and reference should be made to the manufacturer's safety data sheet for the appropriate control measures when working with them.

Oils in a hydraulic system are often under high pressure and may also be hot so beware of leaking hoses, pipes, etc. These should be reported and repaired as soon as possible to prevent injury.

Fluid escaping from a small hole can be almost invisible. Searching for fluid leaks by "FEEL" is a dangerous practice and will eventually result in injury to fingers or even your hand. Use a piece of cardboard, wood, paper or a mirror, instead of your hands, to search for suspected leaks.

Fluid Injection

A pin-hole in a hydraulic line operating at 137 bar (2000 psi) will create an oil exit velocity of approximately 1500 kilometres per hour and can easily penetrate the skin and enter the blood stream. Exposure to pressurised hydraulic oil under pressures as low as 50 bar (725 psi) and below can result in fluid injection or other serious injuries (e.g. to the eyes and other sensitive areas of the body).

Any person receiving or suspected to have received a pressurised fluid injection, no matter how small should present to a medical facility for further examination and treatment.

(Note: The person must not be left alone or allowed to drive themselves to the medical facility.)

Medical Considerations

High pressure injection of a fluid constitutes a medical and surgical emergency even if the wound appears small. The following apply to all potential fluid injections:

- > Nil food or drink
- > Methoxyflurane if required
- > Superficial clean with saline
- > Lightly cover the wound, do not use compression bandages or pressure
- > Elevate and splint affected limb
- > Ice pack may help pain

Urgent surgical treatment is required to reduce the long-term implications of this type of injury.



Figure 108. Person in hospital following fluid injection injury



Figure 109. Fluid injection injury to hand following surgery

Hydraulic fluids trapped in the tissue cannot be easily removed and instances of gangrene have often occurred. It is important **not** to put your finger or any part of your body over a jet of fluid that may be observed coming from a faulty hose, fitting or other leak.

FLUID POWER SYSTEM DESIGN

Hydraulic systems

A confined fluid is one of the most versatile means of controlling motion and transmitting power.

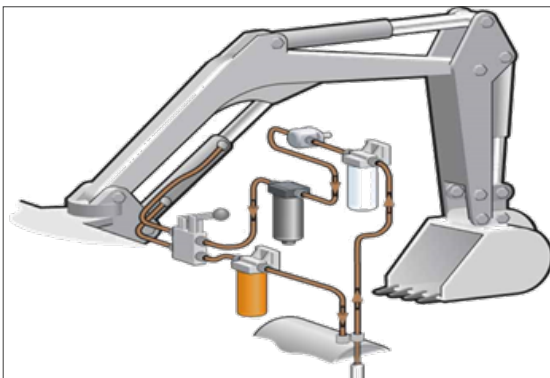

Figure 110. Hydraulic hose diagram for boom lift cylinder - arrows show direction of flow



Fluid power, or specifically hydraulic systems, operate on the following basic principles:

- > A hydraulic pump is used to create a flow of an incompressible fluid.
- > A pressure can then be generated on a surface by restricting the flow of a fluid.
- > If actuators (such as hydraulic cylinders) are placed in the flow of fluid, a pressure will be exerted on the piston of the cylinder, resulting in a mechanical movement of the piston.
- > As a result, this mechanical movement causes the arm of the digger to extend or retract. A flow of fluid in the opposite direction will cause mechanical movement in the opposite direction.

(Note: Flow makes it go.)

Pressure acting on the surface of the piston produces force, and force from the hydraulic cylinder produces work by causing the arm of the digger to move. Hydraulic systems are used in many applications such as trucks, cranes, dumpers, bulldozers and excavators.

Fluid power systems should be designed and components selected to provide safe operation over the intended design lifecycle of the systems. Seals and sealing devices should be compatible with the fluid used, adjacent materials, working conditions and environment. Fluid systems should be designed to minimise excessive heat generation.

Rated working pressure

To avoid pressurised fluids escaping into the environment, fluid power system components should have appropriate factors of safety on the rated working pressure to bursting pressure such as:

- > Hose assemblies should have a factor of safety of at least 4:1
- > Adaptor fittings should have a factor of safety of at least 4:1 on rated working pressure to catastrophic failure of the adaptor or fitting
- > Other fluid power components, such as cylinders, valves, actuators or similar should have a factor of safety of at least 2.5:1.

Where the above safety factors are reduced, appropriate engineering analysis and cycle and endurance testing should be carried out and documented. ISO 7751 provides guidance.

When considering a factor of safety for components for fluid power system, due consideration should be given to the fatigue life of the component.

Excessive pressures

A means or device should be provided to protect the circuit against excessive pressures (e.g. a relief valve (refer ISO 4413, ISO 4414 and AS 4041 as appropriate)).

The device should be:

- a) purpose designed to suit maximum flow rate which may include rare events (e.g. the impact of major roof falls on longwall hydraulics)
- b) adequately supported and mechanically protected from damage in high wear or impact areas
- c) positioned for access for maintenance purposes
- d) positioned to reduce the ingress of contaminants from the environment.

Protection from uncontrolled escape of pressurised fluids

The design should minimise the risk of injury to operators and maintenance personnel from the uncontrolled escape of pressurised fluids. Controls should be provided in accordance with the hierarchy of controls.

Consideration should be given to:

- a) routing hoses, pipes and pressurised components away from high risk areas, or otherwise as far away as is possible
- b) use of protective fixed guards to prevent escaped fluids entering work areas
- c) use of devices to divert or disperse the escaped fluid
- d) providing means to detect a potential component failure before it occurs
- e) providing means for effective isolation, energy dissipation and verification, refer Clause 3.6.

It is not considered acceptable to solely rely on PPE in high-risk areas.

Unintended pressure intensification

In order to prevent pressure intensification in a hydraulic system and failure of that system, a means should be provided to prevent unintended pressure intensification on all fluid power systems, in particular hydraulic cylinders, such as unloader valves, relief valves and burst discs.

Fluid power systems should be designed and manufactured using existing engineering standards and principles so it is fit for the intended purpose and is safe to use by a competent person.

Fluids

Fluids should be compatible with the system's components.

Manual controls

Hazardous conditions caused by inadvertent operation of the controls should be considered in the design, and be minimised.

Where the operation of the control may create a hazard, the system should be safe guarded in accordance with AS/NZS 4024.1.

All controls should be accessible for maintenance.

Ergonomics

An ergonomic assessment on the layout of all fluid power controls and operator gauges should be carried out. A person competent in ergonomic assessments should carry out an ergonomic assessment. Guidance for ergonomics in the workplace can be found in AS/NZS 4024.1 series of standards.

Direction of movement

The direction of movement for manually operated levers should be consistent with the direction of operation of the actuator (i.e. lever up raises actuator. AS/NZS 4024.1906 provides guidance on general principles.

The direction of the manual control lever should not be confusing. Manual controls should be clearly and permanently identified.



Hose service life

Storage and age control can affect hose life. The following should be considered:

- > A system of age control should be implemented to ensure hose assemblies are used prior to shelf life expiration.
- > Storage areas should be relatively cool and dark, as well as free of dust, dirt, dampness and mildew.
- > Storage of tested hose assemblies should be limited to two years from inspection. Hose assembly stored for more than two years should be visually inspected and proof tested, or follow the manufacturer's recommendations.
- > Hose assemblies with a hose older than five years (five years or greater post cure date) should be re-proof tested and hose assemblies with a hose older than eight years should be discarded unless otherwise recommended by the hose manufacturer. After successfully retesting, the hose assemblies should be clearly remarked.

Proper hose installation is essential for satisfactory performance. If the hose length is excessive, the appearance of the installation will be unsatisfactory and unnecessary cost of equipment will be involved. If hose assemblies are too short to permit adequate flexing and changes in length due to expansion or contraction, hose service life will be reduced.

Premature failure of hose assemblies

Statistics on the failure of flexible hose assemblies in workplaces indicate that the major mechanism of hose failure is abrasion followed by stresses inducing pin holing near the hose ends.

Control measures for the risks presented by such failures include:

- > route hose assemblies to avoid abrasive situations
- > cover and protect hose assemblies to avoid abrasion from abrasive material (e.g. accumulation of debris on underground equipment).

Keep stress on hose assemblies to a minimum by:

- > adhering to the manufacturers minimum bend radius (MBR)
- > using a non-flexible length (NFL) adjacent hose ends
- > clamp the hose and use directional hose ends to reduce torsional effects
- > understanding the effects of pressure loading on the hose assembly.

Refer to guidance on next page.

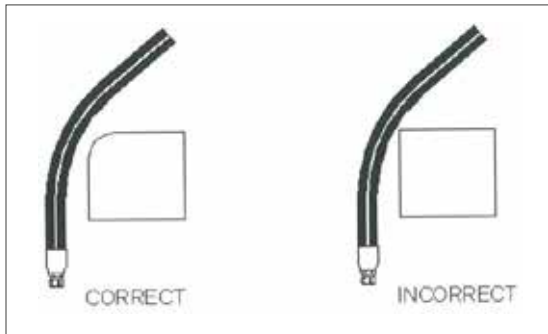

Figure 111. Prevention of external damage

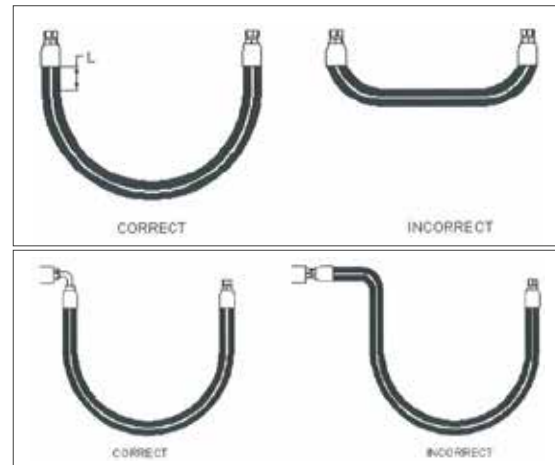

Figure 112. Minimum bend radius

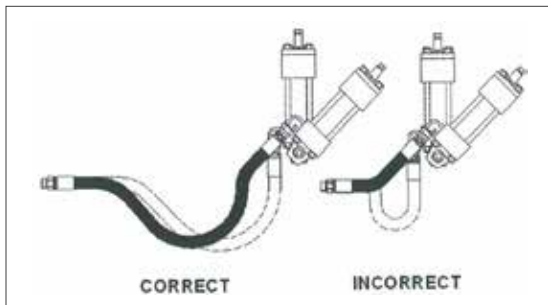

Figure 113. Motion tolerance

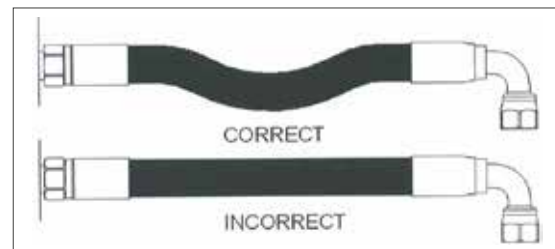

Figure 114. Hose and machine tolerance

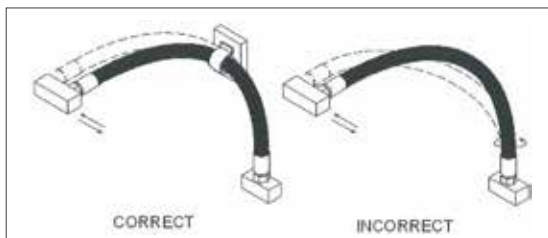

Figure 115. Prevent hose bending in more than one plane

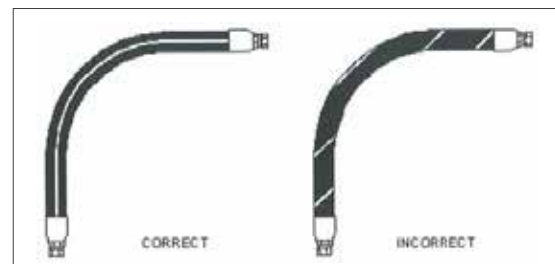

Figure 116. Twist angle

Refer to AS 2671 Hydraulic fluid power, MDG 41 Fluid Power and MDG 3007 Hydraulic safety.

18

PART **D**

Emergency management

IN THIS SECTION:

- 18.1 What is an emergency, and what are my duties?**
- 18.2 Keep it simple and proportionate to the size of the operation**
- 18.3 All emergency management plans should be based on the coordinated incident management system**
- 18.4 Assess potential emergencies**
- 18.5 Identify needs and confirm capability requirements**
- 18.6 Make the plan**
- 18.7 Test, practise and review the plan**

An emergency occurs when there is an unexpected event that requires urgent action to protect the health, safety and wellbeing of workers or other people. Every operation, whether covered by the Regulations or the Act, must have an emergency plan.

This section describes:

- > the process for developing an emergency plan
- > the key questions to answer in emergency planning
- > how to respond to an emergency
- > what to do after the emergency plan is developed.

18.1 WHAT IS AN EMERGENCY AND WHAT ARE MY DUTIES?

An emergency is an unplanned or unexpected event that requires immediate action to protect the health, safety and wellbeing of people. Emergencies occur when controls for hazards fail, putting workers or other people at an immediate risk of harm. Re-establishment of controls, or use of emergency management controls, is urgently required before somebody is harmed.

Clause 43 of the WHS Regulation requires all PCBUs to prepare an emergency plan for the workplace including emergency procedures, training and testing of the plan.

Clause 88 and schedule 7 of the WHSMPS Regulation detail specific matters that must be included or considered when developing the plan.

An emergency plan is a principal control plan under the WHSMPS Regulation and forms part of the safety management system of the mine.

Where there is potential for an emergency, this should include the development of an emergency plan. When developing an emergency plan, the work should be undertaken with a realistic view that an emergency will likely occur in the near or distant future. Every site must plan for these events. A good emergency plan should be developed using a risk-based process. Following the process below will enable operations to answer the right questions in order to develop a plan that is relevant to their specific operation.

Requirements for the emergency plan at a surface mine may be summarised as:

Emergency procedures, for an effective response to an emergency including:

- > evacuation procedures
- > notifying emergency service organisations at the earliest opportunity
- > providing medical treatment and assistance and providing adequate patient transport
- > ensuring effective communication between the person authorised by the PCBU to coordinate the emergency response and everyone else at the workplace
- > a system that enables everyone at the mine to be located promptly

- > the provision of adequate rescue equipment, and ensuring an adequate number of people trained in its use are available to respond effectively
- > appropriate transportation (or suitable means of exit by walking) for people at risk to a place of safety including during an emergency evacuation.

Testing of the emergency procedures, including how often they should be tested.

Information, training and instruction to relevant workers in relation to implementing the emergency procedures.

A statement of **potential triggers** for the activation of the plan.

Matters specified in Schedule 7 (this includes site and hazard details, workers and command structure in emergencies, notifications, resources and equipment and specified procedures).

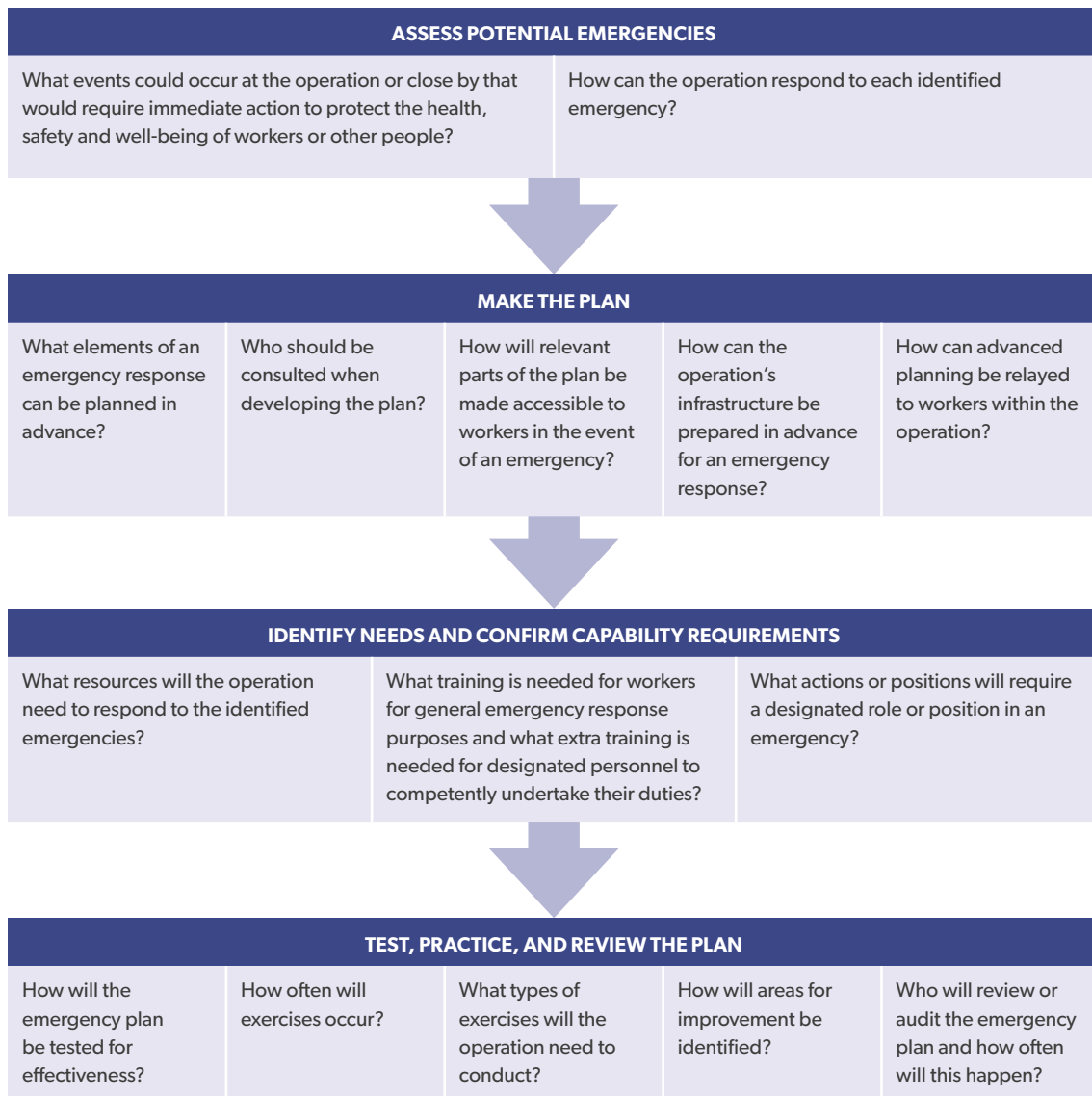

Figure 117. Developing an emergency plan

18.2 KEEP IT SIMPLE AND PROPORTIONATE TO THE SIZE OF THE OPERATION

For an emergency plan to be effective, it should be kept as simple as possible and proportionate to the size and scope of the operation. Larger operations and operations that carry principal hazards will require more complex plans, more trained workers and more on-site equipment than less complex small operations. Regardless of the size of the plan or the operation, the actions for workers to take in an emergency should be accessible and easy to follow. In small operations, having the basics of emergency management in place should be sufficient. In larger operations and operations with principal hazards, there will be a greater need for a more detailed emergency plan.

However large or small, an emergency plan should be accessible and understood by the workers that must activate it or follow it in an emergency. This can be done by developing procedures for actions that should be taken in an emergency, and keeping them in a single place, visible to all workers and emergency services. It can be helpful to include workers who have had experience in emergency work as they can help identify emergencies and the response procedures needed.

18.2.1 LONE WORKERS AND SMALL OPERATIONS

Small operations and lone workers/operators have different needs to larger operations due to the limited resources that are available. Taking the following actions should be considered:

1. Notifying emergency services of location and entry point to site.
2. Providing GPS coordinates to emergency services.
3. Providing adequate means of communication.
4. Maintaining up-to-date first aid certificates and providing adequate first aid material including bandages, splints, blankets and a cage stretcher.
5. Setting out a suitable place to land a helicopter.
6. Providing a list of essential phone numbers to request assistance.

Lone workers should be aware that nobody will be on site to call emergency services in the event they become injured or trapped. Where there is no service for mobile phones, personal locator beacons could be carried when working on site to be activated in the event of an emergency. This will enable distress signals to be received by emergency services. See 13.8 for more information on remote or isolated work.



Figure 118. Example emergency station

18.3 ALL EMERGENCY MANAGEMENT PLANS SHOULD BE BASED ON THE COORDINATED INCIDENT MANAGEMENT SYSTEM

Sometimes emergencies can escalate from a minor, site level incident to a large multiagency emergency response. At other times, the incident may be so serious that a large multi-agency response is required immediately. A large response uses the Australasian Inter-service Incident Management System (AIIMS) developed by the Australasian Fire & Emergency Services Authorities Council.

18.3.1 WHAT IS AIIMS?

AIIMS is an emergency response system that describes:

- > how NSW agencies coordinate, command and control their response to an incident of any scale
- > how the response can be structured
- > the relationships between the respective AIIMS functions
- > the relationships between the levels of response
- > AIIMS can expand or shrink to fit any type of emergency. However, it is easier for AIIMS to support large scale emergencies when the fundamental principles are used in the emergency management plan. See the Australian and New Zealand National Council for fire, emergency services and land management website for more information. www.afac.com.au

18.4 ASSESS POTENTIAL EMERGENCIES

All PCBUs at mines must ensure there are effective methods in place for the identification and assessment of hazards, whether new or existing.

18.4.1 WHAT HAS THE POTENTIAL TO CAUSE HARM AT THE OPERATION?

A good risk appraisal should uncover all hazards on the site and in close proximity. Operators should look not only at the hazards on site, but also in the surrounding environment. For example, there may be a risk of bush fire or flood. Operators should also look at other risk assessments and incident investigations that have been completed.

18.4.2 WHAT'S THE WORST THAT CAN HAPPEN?

Operators should be asking themselves what could be the worst-case scenario when assessing each hazard. Following identification of the worst-case scenario, operators should determine how that may affect workers or other people in the vicinity of the operation and how they may need to respond to prevent or minimise damage. If the controls for the hazard fail and urgent action is required to protect the health, safety and wellbeing of workers or other people, an emergency plan for that hazard is required.

Greater focus should be placed on hazards that have the potential to result in a fatality or a permanent injury. However, an even greater level of focus should be placed on principal hazards that exist at the mine. All mines must prepare an Emergency management principal control plan (EMPCP). See the Resources Regulator's *Emergency planning for mines code of practice*.

Once potential emergencies have been identified, they should be assessed for the most practical response, having regard to the resource and capability within the operation, as well as the size of the operation.

18.5 IDENTIFY NEEDS AND CONFIRM CAPABILITY REQUIREMENTS

Following the risk identification and assessment in which potential emergencies and responses have been identified, operators should assess what they need to do in order to make the identified responses viable. This includes identifying the necessary equipment and infrastructure, what certain people or positions will be required to do in the case of each emergency and ensuring they are trained to be able to carry out those duties.

18.5.1 WHAT RESOURCES WILL THE OPERATION NEED TO RESPOND TO EMERGENCIES?

Resources include:

- > the equipment that will be required to respond to emergencies, such as rescue equipment, patient transport, fire extinguishers, spill bins and decontamination equipment
- > the written material that should be provided to workers, such as procedures and duty cards
- > the people that will be required including emergency services
- > the location of Emergency Evacuation Points
- > the arrangements needed to ensure everyone at the site can be located and travel to safety (e.g. do they need transport?)
- > the infrastructure or arrangements (including consultation) necessary to support a full scale, multi-agency response.

18.5.2 WHAT ACTIONS OR POSITIONS WILL REQUIRE A DESIGNATED ROLE IN AN EMERGENCY?

The most commonly identified role for an emergency is that of a first aid provider, such as a first aider in smaller operations or a more highly qualified medic in larger operations. All operators, regardless of the size or the hazards they carry, should have one of these. In small operations, this could be a person with a workplace first aid certificate. In some of the larger operations, there can be paramedics or workers trained in pre-hospital emergency care.

Some operations will need people who are trained to extinguish fires. These could be workers who are operating in areas with a high risk of fire or other workers who can extinguish the fire while the worker from that area escapes safely.

A worker may also be needed to ensure all workers are evacuated from the area of danger by accounting for people. Operators should consider designating appropriate workers to communicate with families, to secure the site to prevent public access and to communicate with emergency services until their arrival. In the event of large scale emergencies where the emergency services are a significant distance from the operation, incident controllers and other experts may be required to commence an AIIMS based emergency operation ahead of their arrival.

18.5.3 WHAT TRAINING IS NEEDED FOR WORKERS IN EMERGENCY RESPONSE AND WHAT EXTRA TRAINING IS NEEDED FOR DESIGNATED WORKERS TO COMPETENTLY CARRY OUT THEIR DUTIES?

Having assessed what resources and positions are required, the next step is to ensure the appropriate workers are trained in the use of the equipment and how to competently fulfil their roles. This is a critical element to ensuring the success of an emergency plan.



A good rule to follow is that any knowledge required for an emergency, that is not ordinarily a part of a worker's day, will need to be provided in the form of training. For example, a first aider will need to be trained in first aid. A person working in an area where there are fire extinguishers provided for a first response will need to be trained in their use. An incident controller or other specialist providing advice to emergency services will need AIMS training. Remote or isolated workers may also require training in effective use of personal locator beacons. Other training may be required in an informal setting, such as training workers on how to quickly and effectively secure the site and who they should allow to come on site in the event of an emergency. Another form of informal training is how to raise the alarm when there is an emergency and what information needs to be provided to emergency services during a 000 call.

18.6 MAKE THE PLAN

Once the key elements of the emergency plan have been developed during the risk, capability and resource assessments, they will need to be brought together with further information in a formal emergency management plan.

18.6.1 WHO SHOULD BE CONSULTED WHEN DEVELOPING THE PLAN?

Workers should always be consulted when developing an emergency plan. As well as general requirements for consulting workers, Clause 121 of the WHSMPS Regulation requires the mine operator to consult workers when preparing, testing and reviewing the emergency plan for the mine. Under Clause 120 and 121 of the WHSMPS Regulation, the mine operator must allow workers to contribute to consideration of control measures for risks to be managed under principal control plans, including the emergency control plan.

Consultation is an important step in emergency planning as front line workers often have good knowledge of hazards. Their point of view may inform the development of the plan.

Coal mines and underground mines are legally required to consult with emergency services. It is not mandatory for surface metalliferous and extractives mines to consult with emergency services but it is recommended, particularly for larger and more complex operations or where the emergency has the potential to impact others (e.g. failure of tailings dams).

Consulting with emergency services can assist with planning in advance. For example, emergency services will be made aware of the presence of the operation in the area, its hazards, its capability, its GPS location and Police will likely wish to know what mobile phone coverage is available. If there is none, Police will then know they will need to bring in a mobile cell tower in the event of a large-scale emergency. In having consulted with emergency services, a significant amount of planning in advance has already been done. Emergency services can also offer advice for further planning that should be undertaken.

Contacting your local Emergency Management Committee may be a good way to consult and coordinate with emergency services in your area as it includes representatives from emergency services organisations. Each local committee is chaired by the local council.

18.6.2 WHAT ELEMENTS OF AN EMERGENCY RESPONSE CAN BE PLANNED IN ADVANCE?

If something can happen during an emergency that can be anticipated and planned for, then it should be included in the Emergency management principal control plan. The only aspects of emergency that cannot be planned for are the unexpected events that happen at the time. There are very few aspects of an emergency that cannot be planned for. Clause 88 and schedule 7 of the WHSMPS Regulation together with clause 43 of the WHS Regulation provides minimum requirements for what must be addressed in an EMPCP.

The coordination and control of emergencies. The plan should set out the incident control arrangements or command structure which should be as simple as possible. There should be a single person in overall charge of operations – this will normally be the manager but other arrangements may also be possible and should be considered.

The plan needs to provide for who will be assigned roles if people are not available. Also consider what other resources may be needed to effectively manage emergency situations. This plan should be able to support AllMS principles in case a larger response is required.

The plan should also list people (or positions) at the site who will have responsibilities in relation to emergencies and the detail of those responsibilities. These will vary with the circumstances of the site and the results of the risk assessment.

These functions may include, but are not limited to:

- > coordinating the emergency response, alerting and liaising with rescue or emergency personnel, regulator personnel and local council staff
- > accounting for people at the site at the time of the incident
- > control of emergency supplies
- > provision and maintenance of facilities for rescue personnel where required and providing plans and other information to rescue personnel as required
- > providing guides or transport of casualties, rescue workers and supplies where required
- > operation of communication systems
- > informing and consulting with worker representatives and next of kin where required
- > management of site security and access
- > communication with the media where required
- > fire wardens and site emergency response teams.

Operations should consider the distance emergency services will need to travel and the time it will take them to respond in an emergency.

Notifications: A procedure to ensure prompt notification of all relevant emergency services should list the details of all relevant emergency services and any other specialist emergency response personnel. Details should include phone numbers and, where relevant, roles within an organisation. Names are only appropriate where there is some certainty the most up to date information is always available.

The events that trigger the activation of the plan: These events come from the identification and assessment of potential emergencies. Examples of events that would trigger the activation of the emergency plan could include:

- > vehicle collision
- > rock fall
- > the presence of smoke or fire
- > medical emergency.

One of the more obvious and well-known activation triggers is upon hearing a worker broadcast over the radio 'emergency, emergency, emergency!'.



The plan should be immediately activated and workers should be trained and empowered to do so with confidence. **It is easy to de-escalate a large emergency once further information comes to hand, but it is impossible to bring back the ten to fifteen minutes of lost time that can ultimately save lives. Therefore, it is better to have a false alarm than a slow start or, worse still, no alarm at all.**

The use of communication systems in emergencies. Determine how and what communication systems are used in an emergency. This can include:

- > clearing radio channels
- > ending all non-essential phone calls
- > communication black-outs
- > the availability of additional communication devices (e.g. satellite phones and the communication systems of the Police).

Good communications are of paramount importance in an emergency, particularly in remote areas and for isolated workers. Suitable communication equipment might range from alarms to more sophisticated public address or closed-circuit television systems. Radios or telephones can enable rapid communication if they are carefully positioned. They may, for example, be fitted to mobile plant or backup service vehicles or issued to appropriate individuals. Electrical systems, radios or mobile telephones may be unsuitable where explosives are in use or where there is a risk of an explosive atmosphere.

The giving of timely notice, information and warnings to anyone potentially affected, including the people nominated as next of kin by workers, is also paramount. Consider:

- > developing a call tree so the right people are notified at the right time
- > determining how and when next of kin will be notified. This may be dependent on the severity of casualties and the location of the next of kin. Notification could be via support services (e.g. Police)
- > determining how and when neighbouring properties will be contacted
- > determining how and when status updates will be communicated.

As a part of the safety management system, emergency contact details for all workers should be prepared and kept up to date through regular reviews.

Measures to be taken to isolate an area affected by an emergency. Measures will be dependent on the type of emergency. Some examples include barriers to block access to unsafe areas or posting sentries at the gate to stop vehicles entering an area. Others may include pre-planning the development of fire breaks to prevent fires from spreading into surrounding areas during an emergency.

The means to locate and account for people in the event of an emergency. Operators must have a system in place to accurately account for and locate all workers or visitors and move them to Emergency Evacuation points in the event of an emergency.

Sign in registers, worker tag boards or radio frequency identification (RFID) tags are some of the ways operators could locate and account for people. A suitable system will depend on the size of the operation or site, the number of workers, the frequency of visitors, working times and shifts and the risks that may be present.

Evacuation in an emergency, including the conditions that will prompt withdrawal when there is an imminent risk of harm. Operators should determine what responses are necessary to ensure all people escape safely and when evacuation is necessary. Evacuation may include first response, self-escape, aided escape or aided rescue.

For example, a person in a confined space may be able to self-escape or may require aided rescue. Prompt withdrawal, for example, may include where smoke alarms are activated, when ground movement has been detected or when weather warnings are issued. Operators should also determine the hazards produced as a result of the emergency that workers self-escaping and self-rescuing may face and what responses are necessary to affect their escape or rescue

Appropriate transportation. You should include in your plan the provision and method for removing all people on site to a designated suitable and safe area. This may include visitors and members of the public.

(Note: walking is a limited option as this plan should include the transport of casualties.)

First aid arrangements including first-aid equipment, facilities, services and the workers who are qualified to provide first aid. Measures will be dependent on the type of incident and the availability and response times of emergency services. See the *First Aid code of practice* for more information on first aid.

An example of some of the equipment that may be needed is when providing first aid to casualties in large vehicles. It can be difficult to remove casualties from height. Attempts made to remove them from the vehicles prior to treating them can cause significant delays in providing treatment and, in some cases, lower the likely survival rate. Having a detachable basket that can be attached to mobile plant for the provision of first aid to drivers of large earthmoving equipment and other mobile plant may be an effective option.

Provision for all aspects of firefighting, including adequate compatible firefighting equipment, procedures for firefighting and training workers in firefighting. Firefighting equipment should be strategically positioned and be of a suitable type for the potential fires that could occur. For example, a fire extinguisher capable of fighting fuel fires should be positioned in all vehicles.

All parts of the emergency plan that require a worker to take action should have a corresponding procedure indicating the steps and actions that must be taken.

Suitable equipment to respond to identified emergencies should be made available for use, so that the plan can be successfully implemented in the event of an emergency. The choice of emergency equipment will depend on the emergencies that have been identified, the complexity of the site and the distance from emergency services. Examples of the type of rescue and emergency equipment which may be required include:

- > breathing apparatus (for confined space entry)
- > ropes
- > ladders (rigid or rope)
- > tripods, winches
- > tools (e.g. pickaxe, crowbar, shovel, cutters)
- > stretchers and blankets
- > buoyancy aids (i.e. lifejackets or lifebuoys)
- > rescue boats
- > chemical spill kit
- > fire extinguishers
- > fire hose reels
- > bush fire kits
- > first aid supplies

- > self-rescuers
- > a mobile generator to power emergency lighting
- > lifting and cutting equipment such as hydraulic props, hardwood wedges in various sizes, lifting bags and cylinders, pneumatic pick
- > resuscitation equipment
- > defibrillator
- > detachable personnel basket for large earthmoving equipment
- > lifting hoops
- > a sanitary area designated for the provision of first aid, such as a first aid room.

Rescue and emergency equipment should be subject to appropriate inspection to make sure it is always ready for use. Where rescue equipment is provided, enough people should be trained to use it without endangering themselves or others. Training in rescue equipment should be specific to the type of emergency (e.g. confined space rescue, heights rescue or use of a fire extinguisher).

Larger operations that use more advanced medical personnel should consult them as to the most suitable equipment for resuscitation and whether they are trained to use it. If not, training should be provided.

Means of escape must be taken into account when designing both fixed and mobile workplaces. An alternative exit should always be provided in mobile equipment. These can be purpose built hatches or windows that can be easily removed or broken with a special tool. Fire extinguishers should also be provided on equipment where there is a risk of fire.

Well-constructed and maintained roadways allow emergency vehicles easier access. These vehicles are generally made for road use and are not suited to difficult terrain. In an emergency, it can be helpful to have a person waiting at the site entrance to direct the emergency services. Where there is a risk of fire, there should be enough room for at least three fire appliances and several other emergency vehicles to park. In remote areas it may be faster for emergency services to respond with a helicopter. An area for a helicopter to land should be planned for and passed to emergency services during consultation.

Important: Don't forget the back-up plan. Sometimes the best procedures do fail, and it is important to have a back-up plan in the event that this happens. A good example of this is fires on mobile plant such as large trucks. These are known to carry an elevated risk of fire, so many operations have a built-in fire suppression system. However, these do not always properly extinguish the fire, so a fire extinguisher is usually provided to finish the job. In the event that the fire extinguisher does not work, there is a procedure in place to withdraw workers and other people from the area and let the fire burn out. When developing procedures, operators should always ask the question: 'if it fails, then what?'

18.6.3 HOW WILL RELEVANT PARTS OF THE PLAN BE MADE ACCESSIBLE TO WORKERS IN THE EVENT OF AN EMERGENCY?

Emergency response and evacuation plans are normally designed as a grab and go procedure, detailing specific actions to be taken in emergency scenarios. Emergency response and evacuation plans may also include signage and bullet point procedures placed in appropriate areas, such as doorways or close to areas where immediate response is required. These should be kept as simple as possible and should contain checklists of tasks in the order in which they should be carried out. They should also be accessible to the workers who have to use them. This can be done by designating a specific area as an emergency area where all emergency

procedures and rescue equipment are kept (aside from equipment that is fixed in specific areas for immediate response) and keeping duplicates close to the areas where immediate response will be required.

For larger operations, the use of TARPs may be appropriate. For smaller operations an emergency response plan flipchart (a set of simple forms that can help you identify and manage your emergency procedures) can be prepared.

Most workers may only need to be able to leave their workplace and go to a designated place of safety in the event of an emergency. Under Clause 43 of the WHS Regulation, the emergency plan must provide for information, training and instruction to relevant workers in relation to implementing the emergency procedures. Workers need to know what to do if an emergency arises. This should be an integral part of training at all operations and should be included in site inductions for workers and other people.

The mine operator should ensure emergency management control plans are regularly tested using practice drills and involving relevant emergency services where practical (e.g. the Fire Service). It is mandatory under clause 93 of the WHSMPS Regulation to test the emergency plan at least every 12 months. It is recommended that testing should be every three months or more frequently as identified through the assessment processes.

18.6.4 HOW CAN THE MINING OPERATION'S INFRASTRUCTURE BE PREPARED IN ADVANCE FOR AN EMERGENCY RESPONSE?

Preparing the site is merely an extension of section 18.5.2 where it is stated that if it can be planned for, the plan should be made. All procedures that have been developed and the equipment required for emergency response should be placed in an area that is easy for all workers on the site and emergency services entering the site to find. This could become a designated emergency station.

Fire extinguishers should be placed where they will be needed (e.g. inside trucks and on barges).

Further copies of response procedures should be placed close to the area in which they will be needed.

When consulting with Police, they may advise what preparation they would like to see undertaken for a large-scale emergency response. Ideally this would be a room for around 15 people with good communication systems and a lot of whiteboard space. This is called the incident control point. However, in small operations, not all sites will have infrastructure that enables this. Advice given from Police should be taken in these situations. Further site preparations should be marked out on a site map that shows the safe forward point, inner and outer perimeters of the operation. The outer perimeter basically marks out the site. The inner perimeter marks out the area that is particularly hazardous, that only the rescue/recovery team should cross. A staging area where emergency services can muster and be briefed should also be marked out. This should be between the inner and outer perimeters and not so close to the incident control point as to disrupt the incident management team.

In larger operations, first aid equipment should be strategically placed on the site to ensure it is easily accessible. All emergency equipment should be marked out on a map of the site and adequate signs to indicate where specific equipment is kept (such as the defibrillator if one will be made available) should be placed around the site.

Figure 119 shows a common incident at quarrying, mining and alluvial mining operations. Operators should determine the worst-case scenario resulting from an emergency of this nature and develop their response plans around minimising harm from there.



Figure 119. Vehicle overturn emergency

18.7 TEST, PRACTICE AND REVIEW THE PLAN

An emergency management plan cannot be said to be effective until every component of the plan is tested in a practical sense. This can be done using a series of exercises which also assists with ensuring the plan is regularly practised, however the plan should continue to be practised regularly once it is said to be effective. When the plan has been tested and practised, or when new hazards arise on site, the plan should be reviewed. It should also be audited on an annual basis to ensure it has been reviewed at times it should have. The plan should also be reviewed following any emergency that occurs on the site.

18.7.1 HOW WILL THE EMERGENCY PLAN BE TESTED FOR EFFECTIVENESS?

Clause 93 of the WHSMPS Regulation requires that the emergency plan be tested at least every 12 months. Ideally it will be tested regularly using practice drills, some of which may involve emergency services where they are willing and able to participate. This enables the emergency services to provide advice on any gaps in training or in the plan that may need to be filled. It also tests the effectiveness of the plan.

Every component should be tested for effectiveness. For larger operations, this means that there should be an exercise that involves the notification of families, accounting for people in the operation and notifying all managers on or off site of the emergency. If there are any areas of the plan that are deemed ineffective, the appropriate amendments should be made and tested again in the next exercise.

Testing should be carried out using realistic scenarios based on the hazards identified and planned for, with further events if it could reasonably be expected that further issues will arise during an emergency.

18.7.2 HOW OFTEN WILL EXERCISES OCCUR AND WHAT TYPES OF EXERCISES WILL THE OPERATION NEED TO CONDUCT?

Clause 104(2)(d) of the WHSMPS Regulation requires the mine operator to ensure that each worker at the mine is provided with suitable and adequate information, training and instruction in the emergency plan for the mine. Under Clause 95 of the WHSMPS Regulation, this training must be provided:

- (a) before the workers commences work at the mine
- (b) as soon as is reasonably practicable after any significant revision to the plan.

This is an important aspect of emergency planning in any operation. Practice drills are essential so everyone knows what to do in an emergency. This includes contractors employed at the site. In the case of contractors

employed on short contracts, visitor training may be more appropriate. Such contractors should be accompanied at all times by a person who has appropriate emergency training.

Exercises should happen, at minimum, on a quarterly basis in order to develop a second nature response in workers on the site. Exercises should be both anticipated for the purpose of training and conducted without the prior knowledge of workers for the purpose of experience. Don't forget to add variety into exercises so that all aspects of the emergency plan can be tested.

The most likely scenarios and life preserving escape and rescue scenarios should be exercised more frequently. Where a worker may be required to take action to save their own life or others, this should be a key area of concentration. Other aspects of the emergency plan should be exercised regularly, but not at the expense of the lifesaving components. The aspects of an emergency plan that will always be used, such as contacting all managers both on and off the site and accounting for people, should be practised during all exercises.

18.7.3 HOW WILL AREAS FOR IMPROVEMENT BE IDENTIFIED?

Nobody has a "perfect plan". Gaps will always be identified in emergencies. Gaps and areas for improvement can be identified using post-exercise debriefs where workers and managers can all state what they considered successful as well as what they deemed unsuccessful. Observers from emergency services can also be used to provide advice. One of the key factors in identifying areas for improvement is not to blame the worker when something goes wrong. Often it can be a case of the procedure not being written simply enough or equipment being unavailable or in the wrong place. Training can also be a factor. Identifying these issues will enable the plan to be reviewed with a view to improving it for retesting at a later stage.

18.7.4 WHO WILL REVIEW OR AUDIT THE EMERGENCY PLAN AND HOW OFTEN WILL THIS HAPPEN?

All plans need to be reviewed and audited on a regular basis. The emergency management plan should contain a section identifying the person or position that will audit the plan to ensure it is compliant, addresses all potential emergencies on the site and is practical. This should be done on a set basis, such as annually. This should be the person with the highest statutory position on site or someone who has particular skills in auditing and review.

The emergency plan should be reviewed after each exercise. The plan must be reviewed at least annually or when there are significant changes to the mining operations. This should be done by the person responsible for developing the emergency management plan in consultation with the person who would normally audit the plan.

When there are significant changes to emergency plans, further consultation with emergency services may be required. Understanding and enacting the emergency plan that has been developed for the operation could save your life and the lives of others.

19

PART **D**

Worker participation

IN THIS SECTION:

- 19.1 Effective consultation
- 19.2 When you must consult workers
- 19.3 Workers' safety role
- 19.4 Worker representation

You must provide opportunities for workers to participate effectively in processes to improve health and safety. Use a worker participation system to manage this process.

This section describes:

- > the legal requirements for consultation including when consultation is required
- > the worker safety role
- > worker representation

Under the *Work Health and Safety Act 2011* all PCBUs must, so far as is reasonably practicable, consult with workers who carry out work for the business or undertaking who are, or are likely to be, directly affected by a matter relating to work health or safety.

A worker is broadly defined to mean a person who carries out work in any capacity for a business or undertaking and includes employees, outworkers, apprentices, trainees, students gaining work experience, volunteers, contractors or subcontractors and their employees.

This means all workers at the mine including contractors and their workers, not just direct employees. Where contractors or their employees are working at the mine regularly or on an ongoing basis, it will usually be easiest to involve them directly in the arrangements for consulting with employees – for example including them in health and safety representative (HSR) or health and safety committee elections and meetings.

19.1 EFFECTIVE CONSULTATION

To help ensure that consultation is effective, the WHS Act prescribes some minimum requirements. Under the WHS Act, consultation requires that:

- > relevant information about the matter is shared with workers
- > workers are given a reasonable opportunity to express their views, raise work health or safety issues and to contribute to the decision-making process relating to the matter
- > the views of workers are taken into account by the person conducting the business or undertaking
- > the workers consulted are advised of the outcome of the consultation in a timely manner.

If the workers are represented by a health and safety representative, the consultation must involve that representative.

The SafeWork Australia's *Code of practice: work health and safety consultation, cooperation and coordination* provides practical guidance on consultation.

19.2 WHEN YOU MUST CONSULT WORKERS

Reasonable opportunities must be provided for employees to participate effectively in improving health and safety at work. The WHS Act and WHSMPS Regulation set out particular circumstances when consultation must be undertaken.

These may be summarised as when:

- > identifying hazards and assessing risks to health and safety

- > making decisions about ways to eliminate or minimise those risks including:
 - developing, implementing and reviewing the safety management system
 - conducting risk assessments for principal mining hazard management plans
 - conducting risk assessments for principal control plans
- > preparing, testing and reviewing the emergency plan for the mine
- > developing and implementing strategies to protect workers from any risk to health and safety arising from worker fatigue, alcohol or drugs
- > making decisions about the adequacy of facilities for the welfare of workers
- > when proposing changes that may affect the health or safety of workers
- > making decisions about procedures for consulting with workers, resolving health or safety issues, monitoring the health of the workers, monitoring the conditions at the workplace and providing information and training for the workers including the implementation of the workers' safety role.

19.3 WORKERS' SAFETY ROLE

Under the WHSMPS Regulation the mine operator of a mine must implement a safety role for the workers at the mine that enables them to contribute to:

- > identifying principal mining hazards that are relevant to the work that the workers are or will be carrying out
- > consideration of control measures for risks associated with principal mining hazards at the mine
- > consideration of control measures for risks to be managed under principal control plans
- > the conduct of a review of a principal hazard management plan.

Implementing a workers' safety role doesn't mean you have to create particular positions or functions. Rather, it requires management to ensure that the consultation arrangements include effective consultation on the matters specified above.

19.4 WORKER REPRESENTATION

At smaller operations consultation is often undertaken informally, for example through:

- > direct discussion on WHS matters often at scheduled safety meetings
- > during meetings – such as daily or weekly work planning
- > tool box talks.

However, particularly as organisations grow, it is often more convenient for everyone to allow workers to elect someone to represent them.

Worker representation provides a means for facilitating consultation, involving workers and giving them a voice in health and safety matters. The WHS Act makes specific provision for two types of representative:

- > A worker may ask for a health and safety representative (HSR) to be elected to represent them on work health and safety matters. If a worker makes this request, work groups need to be established to facilitate the election. Where HSRs have been elected, the PCBU must consult with them.
- > A health and safety committee (HSC) brings together workers and management to assist in the development and review of health and safety policies and procedures. A HSC must be established when a HSR or five or more workers makes a request to the PCBU.

See the SafeWork Australia's *Worker representation and participation guide* for detailed information about worker representation.



20

PART **D**

Information, training and supervision

IN THIS SECTION:

- 20.1 Information, training, instruction or supervision**
- 20.2 Training**
- 20.3 Identify skills, knowledge or competencies**
- 20.4 Induction training**
- 20.5 Providing information**
- 20.6 Training workers**
- 20.7 Supervision**
- 20.8 Use of contractors**
- 20.9 Training records**

Everyone working at the site must be competent for the work they are required to do or be supervised by competent workers. They, and their managers, need to know the limits of their competence.

This section describes how to:

- > identify the skills, knowledge or competencies your workers need
- > train workers when they start work and when they need to learn new skills
- > keep records to prove what training you have provided.

You must provide the information, training, instruction or supervision necessary to workers so they can do their work safely.

This section does not cover formal qualifications, such as certificates of competency required by the Regulations.

20.1 INFORMATION, TRAINING, INSTRUCTION OR SUPERVISION

Providing information, training instruction or supervision to workers is recognised as a critical part of work health and safety and it is included as part of the primary duty of care under the WHS Act.

A person conducting a business or undertaking must ensure, so far as is reasonably practicable, the provision of any information, training, instruction or supervision that is necessary to protect all persons from risks to their health and safety arising from work carried out as part of the conduct of the business or undertaking (s19(3)(f) WHS Act)

The WHS Regulation expands on this obligation with two key requirements:

1. that the information is suitable and adequate
2. that the information is readily understandable by the worker.

To decide what is suitable and adequate you must consider:

- > the nature of the work the person will do
- > the nature of the risks associated with the work at the time the information, training or instruction is provided
- > the control measures implemented.

For example, if the control measures are complex, greater or more formal instruction may be required. Equally, if administrative procedures are a key control, high levels of ongoing supervision may be required to ensure the worker understands and follows the procedure.

Under the WHSMPS Regulation, you must also ensure that workers are provided with suitable and adequate information, training, instruction or supervision on the:

- > hazards associated with the work being carried out by the worker
- > the implementation of control measures relating to the work done by the worker, including control measures in relation to fatigue, the consumption of alcohol and the use of drugs

- > the content and implementation of the relevant parts of the safety management system for the mine before the worker begins work at the mine
- > the emergency plan
- > the safety role for workers implemented under clause 120 of the WHSMPS.

All PCBUs at mines must ensure that workers are trained and competent in basic risk management techniques.

20.2 TRAINING

Training helps people share knowledge and develop skills. It can help influence behaviours and improve health and safety.

A training programme should:

- > identify what skills, knowledge or competencies workers need to do particular tasks
- > have an induction – to show new workers around the site and tell them about hazards and safety procedures
- > provide ways to train workers (e.g. use external training providers or do on-the-job instruction)
- > make sure people only do work if they're trained and competent or properly supervised
- > keep records of workers training and instruction and identify what jobs they can and can't do.

People might need extra training for some processes and machinery. Refresher training and a review of information, training and instruction provided may also be required to ensure the worker has retained the necessary level of skill, knowledge or competency.

20.3 IDENTIFY SKILLS, KNOWLEDGE OR COMPETENCIES

There are multiple ways in which you can determine the competencies needed for particular jobs. These include:

- > risk assessments and hazard identification processes
- > personal performance reviews
- > health and safety audits or inspections
- > analysis of accident investigations and near-miss reports
- > competencies specified by vehicle or equipment manufacturers
- > national qualifications framework
- > recommendations in codes of practice, guidelines or standards
- > those required by the law.

By comparing the competencies needed with those which people already have, managers can determine what additional skills are required and how these can be achieved (e.g. through training and coaching).

20.4 INDUCTION TRAINING

Give suitable induction training to everyone who is new to the mine site or has been absent for an extended period. This is particularly important for those who are new to the industry.

Induction should be job and site-specific and must include information, training and instruction on the safety management system to provide the worker with knowledge of all relevant aspects of the safety management system.

20.5 PROVIDING INFORMATION

The WHSMPS Regulation includes specific requirements about information that must be provided to workers. Some of this information will typically be included in induction programs but there is also an ongoing obligation to provide certain information.

20.5.1 INFORMATION THAT MUST BE PROVIDED BEFORE COMMENCING WORK

Under clause 103 of the WHSMPS Regulation, you must ensure before a worker commences work at the mine that the worker:

- > is given a summary of the safety management system for the mine and informed of the right to see the documented safety management system
- > is given a summary of each principal hazard management plan that relates to any risk that may arise in the course of the worker's work at the mine and the worker is informed of the right to see any principal hazard management plan.

20.5.2 OTHER REQUIREMENTS TO PROVIDE INFORMATION

Clause 103 also requires you to ensure that the documented safety management system is available on request to a worker at the mine including each principal control plan such as the emergency plan.

You must also ensure, so far as is reasonably practicable, that workers are made aware of any revision of the safety management system that is relevant to work they carry out.

20.5.3 INFORMATION FOR VISITORS

Clause 106 of the regulation requires you to ensure that a visitor to the mine who has been authorised by the operator is provided the following information as soon as is reasonably practicable:

- > risks associated with the mining operation to which the visitor will be exposed
- > health and safety precautions the visitor should take at the mine
- > actions to be taken if the emergency plan is implemented while the visitor is onsite.

20.6 TRAINING WORKERS

Education and training can be in-house or a formal program. The aim is make sure each person and the team as a whole can operate safely.

When they have finished training, get them to explain and demonstrate their understanding. Even if a new worker has excellent qualifications and experience, always assess their competence to work on the site.

Further training is likely to be needed whenever:

- > someone takes on substantial new responsibilities
- > there is a significant change in work equipment or systems of work.

Skills decline if they are not used regularly and refresher training should be provided as necessary to make sure continued competence in skills that are not often used (e.g. confined space training).

It can be useful to involve experienced workers in training as they are often best placed to understand the risks involved in their work. However, care must be taken to ensure bad habits are not passed on.

20.7 SUPERVISION

You must have a skilled worker closely supervise new or untrained workers until they can work safely. Supervision continues henceforth, but not as intensely.

20.8 USE OF CONTRACTORS

Mines or quarries may use contractors to undertake some or all of the activities on site. The requirement to provide training and supervision and ensure competency to use plant and equipment applies equally to both in-house and contracted workers. You must fully induct contractors on your company's processes and make sure the contractors follow safe working practices. Contractors should be provided training in and use the site safety management system.

20.9 TRAINING RECORDS

You must keep a record of all training provided to a worker for as long as they work at the mine and make sure it is available to them on request.

Training records could include copies of external training provider certificates, in-house or on-the-job training records, attendance lists and driver's licences.



21

Glossary



TERM	DEFINITION
Affected person (for LOTO)	Is a worker whose job requires them to operate a system, or work in an area in which servicing or maintenance is being performed under LOTO
ANFO	An explosive material consisting of ammonium nitrate and fuel oil
Angle of repose	The angle of repose is the angle at which the material rests when simply dumped in a pile. This angle will vary somewhat depending on the size and shape of the constituent particles, how the material is dumped (e.g. how far it is dropped) and the amount of moisture in the material when it is dumped
Authorised person (for LOTO)	Is an individual who is qualified to control hazardous energy sources because of their knowledge, training and experience and has been given authority to apply LOTO
Back-break	Rock broken beyond the limits of the last row of holes in a blast
Batter	The portion of a slope between benches (see Figure 2 on page 20)
Bench	A safety feature to catch any rocks or reeling material that falls from the high walls above. A horizontal ledge from which holes are drilled vertically down into the material to be blasted
Benching	Benching is a process of excavating where a slope is worked in steps or lifts
Building Code	<i>The Building Code</i> set out in Schedule 1 of the <i>Building Regulations 1992</i>
Competent person	Has the meaning given in clause 3 of the WHS Regulation and, where not specified means a person who has acquired through training, qualification or experience the knowledge and skills to carry out the task.
Confined space	Has the meaning given in clause 3 of the WHS Regulation At a mine, confined spaces can include storage tanks, silos, reaction vessels, enclosed drains and sewers, open topped chambers, ductwork and poorly ventilated rooms
Contractor	In general, a person engaged other than as an employee to undertake work at the site. In the WHSMPs Regulation and in this guide, the term 'contractor' refers to a contractor who conducts a business or undertaking at a mine or a petroleum site other than a delivery, office equipment service, office cleaning, or catering business or undertaking.
Control Control measure	An action taken that eliminates, isolates or minimises a hazard so far as reasonably practicable Eliminating a hazard will also eliminate any risks associated with that hazard.
Crest	The top edge of a slope or batter where the ground levels out
Dam	Dams are man-made structures that store liquids (usually water). They come in many forms and sizes, including water supply dams, tailings and industrial dams, and stormwater detention and retarding dams. "Prescribed" dams are those listed in Schedule 1 of the Dams Safety Act 1978 or declared to be a dam under section 5 of the Dams Safety Act 2015.
De-energisation De-energising De-energise	De-energisation is the process used to disconnect and isolate a system from a source of energy in order to prevent the release of that energy. By de-energising the system, you are eliminating the chance the system could inadvertently, accidentally or unintentionally cause harm to a person through movement, or the release of heat, light or sound
Document Control	The systems by which records are kept, including the allocation of responsibility to specific staff members

TERM	DEFINITION
Dump	May include an overburden tip or waste material tip of a permanent nature. Often called waste dumps or waste rock stacks
Emergency drill	A process of testing training, relating to emergency events, which is repeated from time to time
Emergency (emergency event, emergencies)	An unplanned event that is not controlled where there is a threat to life or the health and safety of people at or outside the operation
Employer	Has the meaning given in section 2 of the HSE Act
FOPS	Falling object protective structure
Face	The surface where extraction is advancing. May also be referred to as pit face or working face.
FRAS	Fire resistant anti-static
Freeboard (for dams)	The distance between normal reservoir level and the top of the dam
Freeboard (for vessels)	The distance between the waterline and the main deck or weather deck of a ship or between the level of the water and the upper edge of the side of a small boat
Haul vehicles	Vehicles used to haul product or material from the place of extraction to the processing plant, stockpile or dump
Hazard	Means a situation or thing that has the potential to harm a person. Hazards at work may include: noisy machinery, a moving forklift, chemicals, electricity, working at heights, a repetitive job, bullying and violence at the workplace.
Hazard assessment	The overall process of analysing and evaluating the hazard
Hazard control	Refer to control
Hazard management	The culture, processes and structures that are directed towards the effective management of potential injury, illness, damage or loss
Hazardous chemical	Has the meaning given in clause 5 of the WHS Regulation
Health and safety representative	Has the meanings given in section 4 of the WHS Act
Heavy vehicles	Includes haul trucks, loaders, scrapers, dozers, water trucks, graders, low loaders, cable reelers, draglines, shovels, backhoes, drills and like equipment Heavy vehicles are those that transport or extract materials, overburden or reject material
Inter-ramp slope	A succession of batters between two access ramp sections (or between a ramp section and floor or crest)
Maintenance	Maintenance that requires interruption to the process. It usually requires shutdown, isolation of hazardous energy, LOTO, opening or disassembly
Light vehicles	Includes wheel mounted light and medium duty vehicles of various sizes which are primarily used in the transportation of people, supplies, tools and fuel or lubricants. They include but are not limited to lube trucks, utes, SUVs, vans used as worker transporters, tyre mounted cranes, forklifts, and so on
LOTO	Lock out and Tag out

TERM	DEFINITION
Maritime rules	Maritime Rules made under the <i>Maritime Transport Act 1994</i>
Mineral	Has the meaning given in section 5 of the WHSMPS Act being the following, but does not include water: (a) a naturally occurring element or inorganic compound, (b) coal, lignite or peat, (c) rock, stone, gravel or sand.
Mining operation	Has the meaning given in section 7 of the WHSMPS Act
Mine operator	Has the meaning given in section 7A of the WHSMPS Act in relation to a particular mining operation, means the mine operator for that mining operation
Misfire	When a blast does not fire correctly, or one or more blast holes do not fire
Mobile plant (for the purpose of this guidance)	Means plant that is not a light vehicle, haul truck or water tanker. For example bulldozer, excavator, loader, scraper and so on
Monitor	To check, supervise, observe or record the progress of an activity or procedure regularly in order to make sure it is being carried out correctly
MOSS	Maritime Operator Safety System
Near miss	An event that has the potential to cause injury or illness if circumstances, such as the interval of time of the event, were different
Non-intrusive maintenance	Maintenance tasks that do not require process interruption, machinery or equipment shutdown, LOTO, entry or disassembly
OHS	Occupational Health and Safety
Overall slope	The full height of a slope from the toe to the crest which may comprise several batters separated by benches (see Figure 3 on page 31)
Overburden	In mining, overburden (also called waste or spoil) is the material that lies above an area of economic interest or the intended quarry site. It is most commonly the rock, soil, and vegetation above a coal seam or ore body
PCP	Principal Control Plan
Personal protective equipment or clothing	Safety apparel, protective devices and equipment that protect the health and safety of an individual person
PHMP	Principal Hazard Management Plan
Policy	Statement by a site (or company) of its commitment, intentions and principles in relation to its overall health and safety performance
Powder factor	The amount of explosive used per unit of rock. Also called Explosive Loading Factor
PPE	Personal protective equipment
Pre-start check	A safety checklist that is undertaken prior to first use of machinery or vehicles for that day or shift

TERM	DEFINITION
Principal control plan (PCP)	Means a plan required under regulation 92 of the WHSMPS
Principal hazard	Has the meaning given in regulation 65 of the WHSMPS
Principal hazard management plan	Means a plan required under regulation 66 of the WHSMPS
Procedure	A set of instructions, rules or a step-by-step description of what's to be done and by whom
Prohibited zone	Zone or area where people are not allowed, such as at the bottom of a working dump face or the loading zone around vehicles
Pyrolysis	Chemical decomposition of compounds caused by high temperatures
Quarrying operation	Has the meaning given in section 19N of the HSE Act
Quarry operator	Has the meaning given in regulation 3 of the Regulations
Restricted area or restricted access	Area or zone where people or vehicles are not allowed unless certain conditions are met. For example, entry to an electrical switchboard room may be restricted to maintenance personnel under a permit to work; light vehicles may be restricted to entering a vehicle operating area when traffic has been stopped
Review	Checking to see whether goals have been achieved, and to assess what needs to be done in the future
Riprap	A layer of large quarried stone, precast blocks, bags of cement, or other suitable material, generally placed on the slope of an embankment or along a watercourse as protection against wave action, erosion, or scour. Riprap is usually placed by dumping or other mechanical methods, and in some cases is hand placed. It consists of rock pieces of relatively large size, as distinguished from a gravel blanket
Roads	A road is a constructed travel way between designated locations designed to accommodate the vehicles that operate at a site. It includes all thoroughfares used by heavy or light vehicles, and any roads used by the public within the site boundaries
ROPS	Roll-over protective structure
Safe work procedure	A written instruction that sets out how an activity is to be undertaken at an operation. It can be used for training or observing activities for monitoring or review. Also known as Safe Work Methods Statement, Standard Operating Procedures, Work Method Statement or Task Analysis
SDS (MSDS)	Safety data sheet (also known as material safety data sheets)
Serious harm	Has the meaning in section 2 of the HSE Act – death or an injury that is defined in Schedule 1 of the HSE Act
Shotfirer	The competent person in charge of, and responsible for, the loading and firing of a blast
Site	A place of work where extractive operations (mining and quarrying) and/or associated activities are carried out
Sleep time (in relation to explosive use)	Sleep time is defined as the time between charging and firing the shot
SOP	Standard operating procedure

TERM	DEFINITION												
Standard operating procedure	Documented, often step-by-step, processes by which workers can perform each task or aspect of the operation												
Stockpile	Material placed, usually on a temporary basis, that is recovered and replaced												
SWL	See WLL												
SWMS	Safe work method statement												
SWP	Safe work procedure												
Toolbox meeting	Formal or informal meeting held between workers, usually at the place the work is undertaken (around the toolbox) and usually before a shift or a specific job starts. Sometimes referred to as a tailgate meeting												
Tourist mining operation	Has the meaning in section 19L of the HSE Act												
Tree-felling	Has the meaning in regulation 2 of the Health and Safety in Employment Regulations 1995. For the purpose of this guidance paragraph (b) (ii) is the aspect of the definition likely to apply. That is “felling trees by manual or mechanical means for the purpose of land clearance”												
Vehicle	Self-propelled equipment or plant used for the carriage of goods, material or people for operational requirements. May include heavy vehicles, light vehicles or mobile plant												
Vehicle operating areas	Other vehicle operating areas are all areas on or at a site where operations involve the use of vehicles other than roads. For example, dump points, stockpiles or loading areas. It includes any vehicle operating areas used by the public within the site boundaries												
Soils and very weak rock	<p>As defined by AS 1726 <i>Geotechnical Site Investigations</i> Table A8 Strength of Rock Material:</p> <table border="1"> <thead> <tr> <th>TERM</th> <th>LETTER SYMBOL</th> <th>POINT LOAD INDEX (MPa) /,50</th> <th>FIELD GUIDE TO STRENGTH</th> </tr> </thead> <tbody> <tr> <td>Extremely low</td> <td>EL</td> <td><0.03</td> <td>Easily remoulded by hand to a material with soil properties</td> </tr> <tr> <td>Very Low</td> <td>VL</td> <td>>0.03 <0.1</td> <td>Material crumbles under firm blows with sharp end of pick; can be peeled with knife; too hard to cut a triaxial sample by hand. Pieces up to 3 cm thick can be broken by finger pressure</td> </tr> </tbody> </table> <p>Note:</p> <ul style="list-style-type: none"> > These terms refer to the strength of the rock material and not to the strength of the rock mass which may be considerably weaker due to the effect of rock defects. > The field guide visual assessment of rock strength may be used for preliminary assessment or when point load testing is not available. > Anisotropy of rock material samples may affect the field assessment of strength. 	TERM	LETTER SYMBOL	POINT LOAD INDEX (MPa) /,50	FIELD GUIDE TO STRENGTH	Extremely low	EL	<0.03	Easily remoulded by hand to a material with soil properties	Very Low	VL	>0.03 <0.1	Material crumbles under firm blows with sharp end of pick; can be peeled with knife; too hard to cut a triaxial sample by hand. Pieces up to 3 cm thick can be broken by finger pressure
TERM	LETTER SYMBOL	POINT LOAD INDEX (MPa) /,50	FIELD GUIDE TO STRENGTH										
Extremely low	EL	<0.03	Easily remoulded by hand to a material with soil properties										
Very Low	VL	>0.03 <0.1	Material crumbles under firm blows with sharp end of pick; can be peeled with knife; too hard to cut a triaxial sample by hand. Pieces up to 3 cm thick can be broken by finger pressure										

TERM	DEFINITION																								
Stronger rock	As defined by AS 1726 Geotechnical Site Investigations Table A8 Strength of Rock Material being:																								
	<table border="1"> <thead> <tr> <th>TERM</th> <th>LETTER SYMBOL</th> <th>POINT LOAD INDEX (MPA) /,50</th> <th>FIELD GUIDE TO STRENGTH</th> </tr> </thead> <tbody> <tr> <td>Extremely high</td> <td>EH</td> <td>>10</td> <td>Specimen requires many blows with geological pick to break through intact material; rock rings under hammer</td> </tr> <tr> <td>Very high</td> <td>VH</td> <td>>3 <10</td> <td>Hand specimen breaks with pick after more than one blow; rock rings under hammer</td> </tr> <tr> <td>High</td> <td>H</td> <td>>1 <3</td> <td>A piece of core 150 mm long by 50 mm diameter cannot be broken by hand but can be broken by a pick with a single firm blow; rock rings under hammer</td> </tr> <tr> <td>Medium</td> <td>M</td> <td>>0.3 <1</td> <td>Readily scored with a knife; a piece of core 150 mm long by 50 mm diameter can be broken by hand with difficulty</td> </tr> <tr> <td>Low</td> <td>L</td> <td>>0.1 <0.3</td> <td>Easily scored with a knife; indentations 1 mm to 3 mm show in the specimen with firm blows of the pick point; has dull sound under hammer. A piece of core 150 mm long 50 mm diameter may be broken by hand. Sharp edges of core may be friable and break during handling</td> </tr> </tbody> </table>	TERM	LETTER SYMBOL	POINT LOAD INDEX (MPA) /,50	FIELD GUIDE TO STRENGTH	Extremely high	EH	>10	Specimen requires many blows with geological pick to break through intact material; rock rings under hammer	Very high	VH	>3 <10	Hand specimen breaks with pick after more than one blow; rock rings under hammer	High	H	>1 <3	A piece of core 150 mm long by 50 mm diameter cannot be broken by hand but can be broken by a pick with a single firm blow; rock rings under hammer	Medium	M	>0.3 <1	Readily scored with a knife; a piece of core 150 mm long by 50 mm diameter can be broken by hand with difficulty	Low	L	>0.1 <0.3	Easily scored with a knife; indentations 1 mm to 3 mm show in the specimen with firm blows of the pick point; has dull sound under hammer. A piece of core 150 mm long 50 mm diameter may be broken by hand. Sharp edges of core may be friable and break during handling
	TERM	LETTER SYMBOL	POINT LOAD INDEX (MPA) /,50	FIELD GUIDE TO STRENGTH																					
	Extremely high	EH	>10	Specimen requires many blows with geological pick to break through intact material; rock rings under hammer																					
	Very high	VH	>3 <10	Hand specimen breaks with pick after more than one blow; rock rings under hammer																					
	High	H	>1 <3	A piece of core 150 mm long by 50 mm diameter cannot be broken by hand but can be broken by a pick with a single firm blow; rock rings under hammer																					
	Medium	M	>0.3 <1	Readily scored with a knife; a piece of core 150 mm long by 50 mm diameter can be broken by hand with difficulty																					
Low	L	>0.1 <0.3	Easily scored with a knife; indentations 1 mm to 3 mm show in the specimen with firm blows of the pick point; has dull sound under hammer. A piece of core 150 mm long 50 mm diameter may be broken by hand. Sharp edges of core may be friable and break during handling																						
Note:																									
<ul style="list-style-type: none"> > These terms refer to the strength of the rock material and not to the strength of the rock mass which may be considerably weaker due to the effect of rock defects. > The field guide visual assessment of rock strength may be used for preliminary assessment or when point load testing is not available. > Anisotropy of rock material samples may affect the field assessment of strength. 																									
WLL	Means the working load limit, the maximum working load designed by the manufacturer. This term is now used instead of SWL (safe working load)																								
Work instruction SOP	See standard operating procedure																								
Worker (for the purposes of this guidance)	A person who works at the site. May include, but not limited to, employer, employees, workers, contractors, sub-contractors, specialists and consultants																								
Worker participation	A system for the participation of workers in health and safety matters, as described in Part 2A and Part 2B of the HSE Act																								
Working bench	The level on which the excavator is sitting on or the trucks are running on																								



22

References

AUSTRALIAN/NEW ZEALAND STANDARDS

- > AS 1657:2018 Fixed platforms, walkways, stairways and ladders - Design, construction and installation
- > AS 1726:2017 Geotechnical site investigations
- > AS 2187:1998 Explosives—Storage, transport and use
- > AS 2294.1:1997 Earth moving machinery – Protective structures
- > AS 2359.13:2005 Powered industrial trucks – brake performance and component strength
- > AS 2550:2011 (Series) Cranes – Safe Use
- > AS 2671:2002 Hydraulic fluid power
- > AS 2865:1995 Safe working in a confined space
- > AS 2958.1:1995 Earthmoving machinery – Safety – wheeled machines – brakes)
- > AS 3868:1991 Earthmoving machinery design guide for access systems
- > AS 4041:1998 Pressure Equipment
- > AS 4326 – The storage and handling of oxidizing agents
- > AS 4343:2014 Pressure equipment – Hazard levels
- > AS 4457.1:2007 Earth moving machinery – off-the-road wheels, rims and tyres – maintenance and repair – wheel assemblies and rim assemblies
- > AS 4606:2000 Fire resistant and antistatic requirements for conveyor belting used in underground coal mines
- > AS 4758.1:2015 Lifejackets general requirements

- > AS/NZS 1270:2002 Acoustics – Hearing protectors
- > AS/NZS 1337.1:2010 Personal eye protection – Eye and face protectors for occupational applications
- > AS/NZS 1715:2009 Selection, use and maintenance of respiratory protective equipment
- > AS/NZS 1716:2012 Respiratory protective devices
- > AS/NZS 1801:1997 Occupational protective helmets
- > AS/NZS 1891.1:2007 Industrial fall arrest systems and devices – Part 1: Harness and ancillary equipment
- > AS/NZS 1891.3:1997 Industrial fall-arrest systems and devices – Part 3: Fall-arrest devices
- > AS/NZS 1892.1:1996 Portable ladders metal
- > AS/NZS 2161.2:2005 Occupational protective gloves
- > AS/NZS 2161.3:2005 Occupational protective gloves – Protection against mechanical risks
- > AS/NZS 2210.1:2010 Safety, protective and occupational footwear – Guide to selection, care and use
- > AS/NZS 3000:2018 Wiring Rules
- > AS/NZS 3007:2013 Electrical equipment in mines and quarries – Surface installations and associated processing plant
- > AS/NZS 3760:2010 In-service safety inspection and testing of electrical equipment
- > AS/NZS 3788:2006 Pressure equipment – in-service inspection
- > AS/NZS 4024.1604:2014 Safety of Machinery - Design of controls, interlocks and guarding – Emergency stop – Principles for design
- > AS/NZS 4024.1904:2014 Safety of machinery - Displays, controls, actuators and signals – Indication, marking and actuation – Requirements for visual, auditory and tactile signals.
- > AS/NZS 4024.1906:2014 Safety of machinery - Displays, controls, actuators and signals - Indication, marking and actuation - Requirements for the location and operation of actuators
- > AS/NZS 4024.3610:2015 Safety of Machinery – Conveyors – General Requirements
- > AS/NZS 4024.3611:2015 Safety of Machinery – Conveyors – Belt Conveyors for Bulk Materials Handling
- > AS/NZS 4602.1:2011 High visibility safety garments – Part 1: Garments for high risk applications
- > AS/NZS 4871.6:2013 Electrical Equipment for Mines and Quarries

INTERNATIONAL STANDARDS

- > ISO 12402 Personal flotation devices
- > ISO 3449 Earth-moving machinery -- Falling-object protective structures -- Laboratory tests and performance requirements
- > ISO 3471 Earth-moving machinery -- Roll-over protective structures -- Laboratory tests and performance requirements
- > ISO 4413 Hydraulic fluid power -- General rules and safety requirements for systems and their components
- > ISO 4414 Pneumatic fluid power -- General rules and safety requirements for systems and their components
- > ISO 7751 Rubber and plastics hoses and hose assemblies -- Ratios of proof and burst pressure to maximum working pressure

OTHER CODES

- > the Australian Design Rules
- > the Australian Code for the Transport of Dangerous Goods by Road and Rail (ADG Code)
- > the Australian Code for the Transport of Explosives by Road and Rail (Australian Explosives Code)
- > National Construction Code of Australia
- > National Standard for Commercial Vessels Part C Design and construction – Section C6 Stability - Subsection 6A Intact stability requirements.

SAFEWORK AUSTRALIA PUBLICATIONS

- > Confined spaces code of practice
- > Excavation work code of practice
- > First Aid code of practice
- > First Aid in the workplace code of practice
- > General guide for industrial lift trucks for more information
- > General guide for working in the vicinity of overhead and underground electric lines
- > Guide for preventing and responding to workplace bullying code of practice
- > Hazardous chemicals requiring health monitoring

- > Hazardous manual tasks code of practice
- > Managing noise and preventing hearing loss at work code of practice
- > Managing risks of hazardous chemicals in the workplace code of practice
- > Managing risks of plant in the workplace code of practice
- > Managing the risk of falls at workplaces code of practice
- > Managing the work environment and facilities code of practice
- > NSW Construction work code of practice
- > Security plan for the storage and handling of explosives (including explosive precursors) guide
- > Work health and safety consultation, cooperation and coordination code of practice
- > Worker representation and participation guide
- > Welding processes code of practice

RESOURCES REGULATOR PUBLICATIONS

- > Electrical engineering control plan code of practice
- > Emergency planning for mines code of practice
- > Managing risks in mining
- > Managing screens and screen maintenance in extractive mining
- > MDG 15 *Mobile and transportable plant for use on mines and petroleum sites*
- > MDG 41 *Fluid Power*
- > MDG 3007 *Hydraulic safety*
- > Mechanical engineering control plan code of practice
- > Notification of incident and injury guide
- > Notification of other matters (including reportable events)
- > Notifying the regulator of a high risk activity
- > Principal hazard management plans guide
- > Safety Bulletin SB15 – 04 *Collisions of mobile elevated work platforms increasing*
- > Safety management systems in mines code of practice

- > Statutory functions guide
- > Understanding the term 'mining operations'

LEGISLATION

- > *Building Act 2004*
- > *Coal Mine Health and Safety Act 2002*
- > *Dams Safety Act 2015*
- > *Explosives Act 2003*
- > Explosives Regulation 2013
- > Heavy Vehicle National Law (NSW)
- > *Marine Safety Act 1998*
- > *Marine Safety (Domestic Commercial Vessel) National Law Act 2012*
- > *Mine Health and Safety Act 2004*
- > NSW Road Rules 2014
- > *Work Health and Safety Act 2011 (WHS Act)*
- > *Work Health and Safety (Mines and Petroleum Sites) Act 2013 (WHSMPA Act)*
- > Work Health and Safety (Mines and Petroleum Sites) Regulation 2014 (WHSMPA Regulation)

OTHER PUBLICATIONS

- > Hurwitz D.S *Backing collisions: A Study of Drivers' Eyes and Backing Behaviours using Combined Rear-view Camera and Sensor Systems.*
- > Girard J. M. *Assessing and monitoring open pit mine highwalls.*
- > Charman P, Murphy B *Soils: Their Properties and Management*
- > USA Department of Labor Mine Safety and Health Administration (MSHA) *Best Practices section of the Controlling Mercury Hazards in Gold Mining: A best practices toolbox*
- > Read J, Stacey R *CSIRO Guideline for Open Pit Slope Design*
- > The Australian Explosives Industry and Safety Group (AEISG) *Code of Practice Mobile Processing Units Edition 3*

OTHER

- > Australian National Committee on Large Dams the ANCOLD Guidelines
- > Queensland Department of Employment, Economic Development and Innovation, Explosives Inspectorate, Safety Alert No. 44 V2, 15 March 2011 *Prevention and management of blast fumes*
- > Welding Technology Institute of Australia (WTIA) *Health and Safety in Welding 2013 – Technical Note 7*

